

International Conference on Ultrafast Optical Science (UltrafastLight-2019), is the broad-scope, annual international symposium dedicated to the most important aspects of ultrafast phenomena in different fields of natural sciences and engineering.

The Conference topics:

1. Extreme light
2. Ultrafast phenomena in condensed matter and ionized gases
3. Ultrafast laser nanofabrication and nanophotonics
4. Femtosecond non-linear optics. Filamentation.
High field THz generation.
5. Femtosecond laser photobiology and photochemistry.
6. Physics and technology of ultrafast lasers and ultrashort laser pulses.
7. Femtosecond radiation in spectroscopy and optical frequency metrology.

Website: www.ultrafastlight.ru

E-mail: ultrafastlight@lebedev.ru

ultrafastlight@gmail.com

Chair - Nikolay Kolachevsky (Lebedev Physical Institute),

Vice-chair - Andrey Ionin (Lebedev Physical Institute),

Vice-chair - Sergey Kudryashov (ITMO University / LPI)

Conference sponsors:



AVESTA
LASERS AND OPTICAL SYSTEMS

<http://www.avesta.ru/en/>



Amplitude

<https://amplitude-laser.com/>



**АЗИМУТ
ФОТОНИКС**

<http://www.azimp.ru/>



<https://minobrnauki.gov.ru/>



**СПЕЦИАЛЬНЫЕ
СИСТЕМЫ**
ФОТОНИКА

<https://sphotronics.ru/>



лабораторное оборудование

<https://www.czl.ru/>



<https://lasercomponents.ru/>

Amplitude

Website: <https://amplitude-laser.com/>

Ultrafast laser technology, recognized by the 2018 Nobel Prize awarded to Donna Strickland and Gérard Mourou, revolutionizes scientific research, industrial manufacturing processes and health. Since 2001, Amplitude has been the international leader in designing, manufacturing and commercializing ultrafast lasers. With a large product portfolio and more than 300 employees internationally, Amplitude offers a full ultrafast laser product range, that is powerful, reliable and easy to use.

Lasers For Industry

Leveraging 17 years' experience in femtosecond laser technology and built in a production center certified by ISO 13485:2016 and ISO 9001:2015 standards, find below our range of industrial compact femtosecond lasers.

Whether for micro-machining, pixel repair, cornea cutting, or mores, these lasers were conceived specifically to respond to the different and emerging needs of our clients.

Lasers for Science

We specialize in high energy ultrafast lasers using Ti:Sapphire and Yb technologies. Based on our unique laser engineering capabilities, we offer Petawatt class Ti:Sapphire lasers associating performance with flexibility. We guarantee specifications as measured by our de facto standard proprietary metrology tools. Leveraging the advantage of the Amplitude group leading Yb core technologies, we also offer high repetition lasers for researchers in the fields of accelerators, material science and life science.

Nanosecond Advanced Lasers

Our product family of Nanosecond Advanced Lasers offers specific and original Laser solutions in response to the ever more innovative demands of our customers. Combining the know-how of the various companies of the Amplitude group, our offer ranges from millijoule to kiloJoule, from near infra-red to UV, or also from sub-ps to μ sec with variable temporal pulse shapes.

We address scientific applications (OPCPA pumping, Ti:Sa, Laser driven Shock coupled to the largest accelerators, Visar, Thomson scattering plasma characterization ...) but also industrial applications (Laser shock peening, Laser Bond Inspection ...) with the ambition to support the success of our customers.

Our Identity

Amplitude has been the global specialist in ultrafast lasers for industrial, medical and scientific applications. Combining research and innovation, we accompany our clients in their projects towards industrial efficiency.

Amplitude is the only international specialist to cover both ultrafast lasers technologies and their applications. With 3 production sites and subsidiaries in Europe, Asia and United States of America, Amplitude offers both service quality and proximity to its customers.

Our ambition

To Become Our Customers Chosen Partner

Becoming the chosen partner for our customers' projects means envisaging future uses of the ultrafast laser, for applications not yet imagined. Ultrafast laser technology is already implemented in multiple sectors such as physics and chemistry research, applied research, ophthalmology, electronic components, semiconductors. Thanks to both our technological research and our geographical reach, we can respond to an even wider field of applications in industrial, medical and scientific fields.

Our Strengths

Strengths That Set Us Apart And Drive Us Forward

A Multicultural Company

Our employees are our greatest strength! To face the challenges of today and tomorrow, Amplitude relies on the know-how and skills of all its employees located across North America, Asia and Europe. This diversity singles us out and also gives us a rich foundation in the sharing of knowledge.

Innovation From The Very Beginning

Since its creation, Amplitude has invested consistently in the design and manufacture of high performance, reliable and easy-to-use ultrafast lasers. We are no longer just a laser manufacturer, we are a major actor in both the technological and scientific communities, having been recognized with multiple awards:

- > 2008 PhAST / Laser Focus World Innovation Award for Amplitude Laser
- > 2012 Prism Award for our Satsuma laser for best industrial laser (San Francisco)
- > 2013 Innovation award by I.N.P.I. – Insitut National de la Propriété Intellectuelle
- > 2016 “Croissance Internationale” award by Biznext/La Tribune
- > 2017 EUREKA award as best project of the year
- > 2017 Tangor laser nominated as best industrial laser at Prism Award (San Francisco)

Quality and Reliability

As the international leader in ultrafast lasers, Amplitude is committed to the design and manufacture of reliable and easy-to-use lasers, adhering to the best quality standards, including ISO 9001 and ISO 13485 certification. Amplitude ultrafast lasers are now known for their reliability, longevity and ease of use.

АЗИМУТ ФОТНИК

Website: <https://azimp.ru/>

Компания АЗИМУТ ФОТНИК – Ваш ориентир в мире Фотоники Основным направлением деятельности компании АЗИМУТ ФОТНИК является поставка оптоэлектронных компонентов и готового научного оборудования ведущих мировых производителей на территории России и СНГ, разработка новых проектов, техническая и информационная поддержка клиентов. В нашем каталоге представлен широкий ассортимент лазерно-оптических компонентов для научных и промышленных применений: - Лазеры Cobolt, Menlo Systems, Lytid, PicoQuant; - Научные камеры XIMEA, NET GmbH и Specim; - Детекторы ИК излучения InfraTec и Heimann Sensor; - Детекторы рентгеновского излучения Detection Technology, Advacam; - Детекторы счета фотонов Becker&Hickl и Micro Photon Devices; - Оптомеханические компоненты SmarAct, Piezosystem Jena и 3DOptix; - Фотодиоды, лазерные диоды и модули, оптические элементы Laser Components.

THORLABS

АЗИМУТ ФОТНИК является официальным дистрибьютором продукции THORLABS в России, ведущего поставщика широкого спектра оборудования для оснащения научных лабораторий и институтов по всему миру. На нашем сайте www.azimp.ru представлен полный каталог продукции THORLABS на русском языке с ценами в российских рублях с НДС.

 **Edmund**
optics | worldwide

Компания АЗИМУТ ФОТНИК имеет официальные соглашения с крупнейшим производителем оптических компонентов и систем, компанией Edmund Optics, которая занимается разработкой и производством многоэлементных линз, покрытий для оптических элементов и систем визуализации с 1942 года.

gentec-€

Компания АЗИМУТ ФОТНИК является представителем компании

Gentec-EO, лидера в разработке и производстве детекторов и электроники для измерения параметров лазерного пучка. **Gentec-EO** уже более 45 лет поставляет свое оборудование для проведения измерений, соответствующих стандартам NIST, для промышленности, научно-исследовательских лабораторий и медицинских учреждений. В 2010 году компания расширила ассортимент своих детекторов для работы в терагерцовом диапазоне. Она также известна как первый мировой поставщик калориметров с большой апертурой для измерения самых высоких энергий импульсов. Официальные соглашения с нашими поставщиками позволяют нам предложить российским заказчикам еще более привлекательные цены, гибкие сроки поставки, гарантию производителя с отправкой на ремонт и замену, а также квалифицированную техническую поддержку по всему спектру поставляемого оборудования.



Наша компания постоянно развивается и расширяет свой ассортимент. Недавно у нас появилось новое направление по поставке научного оборудования для задач микроскопии, оптогенетики, электрофизиологии оптической томографии и т. д. Наши специалисты помогут Вам подобрать все необходимые комплектующие для вашего эксперимента: от покровных стекол до готовых оптических систем, а также проконсультируют по подбору компонентов для создания нестандартных систем визуализаций любой сложности. По всем интересующим Вас вопросам, связанным с покупкой или применением поставляемого оборудования, пожалуйста, обращайтесь по указанным контактам:

тел.: +7 (495) 792-39-88,

e-mail: info@azimp.ru, web: www.azimp.ru, www.azimp-micro.ru

Адрес в Москве: 115191, ул. Большая Тульская, д. 10, стр.5, оф. 514 (м. Тульская)

Адрес в Санкт-Петербурге: 197101, ул. Рентгена, д.7А, оф. 136 (м. Петроградская)

Avesta

Website: <http://www.avesta.ru/en/>

Core competence: Avesta develops and manufactures femtosecond laser oscillators and amplifiers (both solid-state and fiber-based) as well as ultrafast diagnostic tools and various laser components. We offer Ti:Sapphire, Yb-doped, Cr:Forsterite solid-state ultrafast and CW lasers, as well as Er-doped and Yb-doped ultrafast fiber lasers. In the field of diagnostics we offer pulse duration measurement devices, spectrometers, spectral phase measurement. In components we offer pulse pickers, harmonic generators, Faraday rotators and isolators, optical attenuators, THz generators, Raman shifters, hollow-fiber pulse compressors and dispersion management units. All our systems are produced in-house, we also make OEM systems and components for other customers. Currently (as of 2018) we have an installed base of more than 2000 customers in Russia and more than 700 customers abroad.

Do you export? Yes, we do. We offer almost all of our products (except for separate optomechanics) for export, either directly or via a distributor or a branch office. Please refer to “Contacts“ section for distributor details, however, not all distributor companies are listed there, so contact us for additional details for your country. We usually offer FCA price terms, and we can use major express carriers like UPS and DHL, as well as organize air cargo shipments from major airports. We can accept international bank transfers via SWIFT in USD, EUR, CNY or RUB. Our export experience includes many EU countries, the USA and the Americas, Asia, Australia.

Ownership: we are a privately-owned company with no state/government share.

Customers: our typical customers are universities, high-tech industrial companies, various start-ups and spin-offs.

People and facilities: we currently have a team of more than 50 players ready for any scientific and production challenges. We have our own in-house machine workshop with a full set of CNC turning, milling, cutting, drilling and other production machines, that allows us to tailor even our standard systems to peculiar customer requirements, as well as perform R&D activities and OEM manufacturing. We have cleanroom research and assembly space.

Location: Avesta is situated in an academic town of Troitsk in the south-western part of Moscow. We have quick access to Moscow’s amenities while still enjoying somewhat human-friendlier landscape of the outer city.

The story: our company entered the fascinating world of laser technology in 1990, short before the iron curtain and the Soviet regime fell down. The former scientific superpower that reared Nobel Prize-winning co-founders of the laser

theory Basov and Prokhorov, was gradually dissolving in wild capitalistic atmosphere of the post-Soviet age. At that time high-tech and innovative companies could barely make both ends meet. That is where we had to start.

We took the experience of the old and the desire for knowledge of the young, created a mixture and named it Avesta (formally incorporated in 1992). Using the facilities and scientific background of Quantum Radiophysics Division and Troitsk branch of P.N. Lebedev Physical Institute (initially inspired by N. G. Basov) we started to revitalize the Russian ultrafast laser technology. Later, in 1998, we divided the company into a research and development branch - Avesta Project Ltd. and simply Avesta Ltd., that now develops industrial application and handles component manufacturing.

Gradually the financial situation in Russian R&D and high-tech industry improved with more attention being directed to implementing Western practices of grant-based financing and University-centered R&D models, as well as support for applied technology transfer to industry. Along with growth of the Russian laser market, export sales also became a significant part of our sales revenue.

Laser Components

Website: <https://lasercomponents.ru/>

ООО “Лазерные компоненты“ - российский поставщик комплектующих к оптоэлектронному, лазерному и тепловизионному оборудованию, а также готовых решений для построения комплексных систем безопасности от ведущих производителей Китая, Италии, Израиля, США, Германии и Словении.

Из года в год мы ставим перед собой задачу обеспечивать предприятия, организации, институты наукоемких отраслей современными комплектующими для тепловизионного и лазерного оборудования.

С 2014 года ООО “Лазерные компоненты“ имеет статус эксклюзивного дистрибьютора продукции ведущего китайского производителя охлаждаемых тепловизионных детекторов и модулей “NCRIEO“ (Китай).

В 2017 году ООО “Лазерные компоненты“ стала эксклюзивным агентством по продаже продукции “OLiGHTEK“ в России, Белоруссии, Украине и Казахстане, а также официальным дистрибьютором производителя лазерных подсистем компаний “CNI“ (Changchun New Industries Optoelectronics Tech. Co., Ltd., Китай).

Уже много лет мы являемся официальным дистрибьютором таких производителей как: “CDGM Glass“ (Китай), “LaserPoint“ (Италия), “Duma Optronics“ (Израиль), “Sun Creative technology“ (Китай), “TECHNIK INSTRUMENT“ (Китай), “Simimage“ (Китай), “Dat-Con“ (Словения) и “Sensor-und Lasertechnik“ (Германия).

Вся продукция отличается высокой надежностью, безупречным качеством, безопасностью и удобством в эксплуатации.

Благодаря сотрудничеству с ведущими предприятиями, а также оптически-ми институтами Академии Наук Китая “Лазерные компоненты“ поставляет крупногабаритную оптику с высокими требованиями к материалу, обработке и покрытию.

Профессионализм и мультиязычность сотрудников компании “Лазерные компоненты“ позволяет оперативно связываться с производителями в любой точке мира, не испытывая языковых барьеров, а также проводить контроль качества непосредственно на самом заводе.

Среди наших клиентов более 40 организаций, входящих в структуру госкорпораций Росатома и Ростеха, более 10 организаций ракетно-космической отрасли, а также порядка 30 научно-исследовательских институтов.

Приглашаем к сотрудничеству и выражаем уверенность, что наша ценовая политика позволит нам стать взаимовыгодными партнерами.

“Лазерные компоненты“ - от мелких комплектующих к готовому изделию!

ООО «ПромЭнерголаб»

Website: <http://www.czl.ru/>

ООО «ПромЭнерголаб» занимается поставкой в Россию пикосекундных и фемтосекундных решений лабораторного и промышленного класса более 14 лет.

Представлены широкие линейки пико- и фемтосекундных лазерных систем и дополнительной параметрики компаний Ekspla и Light Conversion.

Флагманами компании Light Conversion являются фемтосекундный лазер PHAROS и оптический параметрический генератор (OPA) ORPHEUS. Основными преимуществами данных систем является возможность оптимизации выходных параметров лазерного излучения конечным пользователем, что делает наши лазеры наиболее гибким инструментом для широкого круга задач. Например, Вы можете изменять такие параметры как средняя выходная мощность, частота следования импульсов и энергия в импульсе, длительность фс импульса. Доступна широкая линейка модификаций с выходной мощностью до 40 Вт и энергиями в импульсе до 2 мДж при частотах следования 1 кГц – 1 МГц и длительностью импульса от 190 фс до 10/20 пс. Также доступны широкие кастомизируемые диапазоны перестройки по длине волны от 190 нм до 16 мкм. В дополнение Вы также можете использовать генераторы гармоник и ОПУ навешиваемого типа, что позволяет сэкономить рабочее пространство, что особенно важно в промышленных приложениях по микрообработке. Кроме того, данные системы могут быть укомплектованы фемтосекундными спектроскопическими системами серии HARPIA и автокорреляторами для анализа переходного поглощения, флуоресцентной ап-конверсии и подсчета единичных фотонов с корреляцией по времени.

Также компания Light Conversion занимается разработкой ОПУ для титан-сапфировых лазеров. Компания Ekspla представляет широкую линейку пикосекундных и фемтосекундных лазерных систем как лабораторного, так и промышленного типов. Главной особенностью компании является широкий выбор номенклатуры, что всегда позволит Вам найти необходимое решение для конкретно Вашей задачи. Среди систем лабораторного класса наибольшую популярность в мире имеют пикосекундные лазерные системы серии PL и оптические параметрические генераторы серии PG. С помощью данных систем Вам доступны энергии от нескольких мДж до 0.5 Дж в импульсе при длительностях импульса порядка нескольких десятков пс на частотах от единиц Гц до 1 кГц, а также имеется возможность конвертации излучения фундаментальной длины волны в высшие гармоники с помощью встраиваемых нелинейных кристаллов. При необходимости получения широких

диапазонов перестройки по длине волны (от 193 нм до 16 мкм) используются системы серии PG, позволяющие получить до 1 мДж при сохранении остальных параметров излучения лазера накачки.

Для получения высоких средней и пиковой мощностей для приложений по микрообработке хорошо себя зарекомендовали лазерные системы серии Atlantic. Данные лазеры отличаются высокой степенью автоматизации, выполнены в цельном монолитном и герметичном алюминиевом корпусе, в большинстве случаев не требуют дополнительного обслуживания и просты в эксплуатации. Доступны различные модификации со средней выходной мощностью вплоть до 80 Вт и энергией в импульсе до 200 мкДж при частотах следования импульсов от сотен кГц до 1 МГц при длительности импульса около 10 пс (1064 нм, 532 нм, 355 нм).

Для задач обычной и ТГц спектроскопии компания Ekspla также производит линейку компактных волоконных пс и фс лазеров: 1064/1030 нм, до 200 мВт, до 250 нДж, 40/50 МГц. Для некоторых модификаций доступна генерация второй и третьей гармоник, а также опциональный селектор импульсов для получения частот следования, начиная от 20 кГц.

Компании ООО Промэнерголаб осуществляет полную поддержку пользователя, начиная с момента в помощи при выборе необходимого решения, и заканчивая поставкой оборудования с вводом в эксплуатацию и обучением конечного пользователя работе с системой. Все наши инженеры являются высококвалифицированными сотрудниками, прошедшими обучение за границей и имеющими необходимые сертификаты.

Специальные Системы. Фотоника.

Website: <http://sphotonics.ru/>

Основой любой оптической системы является источник излучения. Связь, наука, обработка материалов и метрология – лишь малый перечень областей, где, с каждым годом, все шире и шире применяются лазеры и лазерные системы. Лазерные технологии проникают в различные сферы - оптимизируя системы контроля на производстве, медицинские методики лечения и диагностики, разработки в области энергетики и высоких технологий. Лазеры используются в открытии и изучении новых физических эффектов, создании материалов и передаче больших объемов информации по волоконным линиям связи.

Компания **“Специальные Системы. Фотоника”** оказывает техническую поддержку и представляет ведущих мировых производителей лазеров и лазерных систем для научных и промышленных применений. Прямые контракты с более чем 20 производителями лазерных систем позволяют нашей компании обеспечивать заказчиков передовым оборудованием в короткие сроки и с оптимальным бюджетом.

Ключевыми заказчиками лазерных систем являются ВУЗы, научно-исследовательские институты, организации академии наук, федеральные ядерные центры, ведущие научные и производственные центры ВПК, частные компании. География заказчиков компании **“Специальные Системы. Фотоника”** включает организации Российской Федерации (от Калининграда до Владивостока), Республики Беларусь и Республики Казахстан.

Гарантия и сервис

Компания **“Специальные Системы. Фотоника”** осуществляет поставку оборудования исключительно с использованием официальных таможенных процедур и соблюдением необходимых мероприятий по сертификации продукции при ввозе ее на территорию РФ. Квалифицированные технические специалисты нашей компании обеспечивают заказчиков квалифицированной поддержкой на этапе выбора, осуществляют пуско-наладку и обучения специалистов заказчика работе с оборудованием. Специалисты компании **“Специальные Системы. Фотоника”** регулярно проходят обучение и повышение квалификации за рубежом, для обеспечения заказчиков наивысшим уровнем сервиса.

Все поставляемое оборудование обеспечиваются официальной гарантией от производителя. В течении всего срока эксплуатации лазерных систем компания **“Специальные Системы. Фотоника”** обеспечивает техническую поддержку, при необходимости подключая к решению технических вопросов специалистов компании-производителя.

Миссия

Внедрение передовых лазерно-оптических технологий и продукции в производственные процессы, текущие и перспективные разработки российских научных и производственных центров. Активное участие в развитии фотоники в России, как наиболее перспективного направления науки и технологий.

Section 1: Extreme light

Section Chair:

Valery Bychenkov, e-mail: bychenkovvy@lebedev.ru
(Lebedev Physical Institute, Russia)

Program committee:

Anatoly Maksimchuk
(University of Michigan, USA)

Alexander Pukhov
(Heinrich Heine University, Germany)

Andrei Savel'ev
(Moscow State University, Russia)

Scope

Generation of ultrahigh fields

Relativistic optics

Acceleration of electrons, protons, and ions

Secondary electromagnetic emission

Quantum electrodynamics effects

Laser-triggered nuclear processes

X-ray spectroscopy for investigation of high -Z plasma created by ultra-relativistic femtosecond laser pulses

M. A. Alkhimova¹, A. Ya. Faenov^{1,2}, T. A. Pikuz^{1,2}, I. Yu. Skobelev^{1,3},
 S. A. Pikuz^{1,3}, M. Nishiuchi⁴, H. Sakaki⁴, A. S. Pirozhkov⁴, A. Sagisaka⁴,
 N. P. Dover⁴, Ko. Kondo⁴, K. Ogura⁴, Y. Fukuda⁴, H. Kiriyaama⁴, M. Kando⁴,
 R. Kodama^{2,5} and K. Kondo⁴

¹Joint Institute for High Temperatures, Russian Academy of Sciences, Moscow, Russia;

²Institute of Open and Transdisciplinary Research Initiatives, Osaka University, Osaka, Japan;

³National Research Nuclear University “MEPhI”, Moscow, Russia;

⁴Kansai Photon Science Institute(KPSI), National Institutes for Quantum and Radiological Science and Technology(QST), Kyoto, Japan;

⁵Institute of Laser Engineering, Osaka University, Osaka, Japan

e-mail MAAlkhimova@mephi.ru

This work we focused on studying features of X-ray emission from stainless steel plasma generated by femtosecond laser pulses when its intensity on target surface reached ultra-relativistic value $I_{laser} \geq 10^{21} \text{ W/cm}^2$. Plasma formed under these conditions is an effective source of ultra-bright X-ray and gamma radiation, beams of high-energy ions, electrons and neutrons. The characteristics of these sources are extremely sensitive to plasma parameters, and those, in turn, strongly depend on the experimental conditions. Such source usually has a density close to solid, small size $\sim 10 - 20 \mu\text{m}^3$, heated up to 1-3 keV and has a very short existent time in extreme state $\sim 50 \text{ fs} - 2 \text{ ps}$. Accordingly, x-ray radiation diagnostic is a key tool allowing to provide the monitoring of plasma source parameters. We report about x-ray spectroscopy measurements that were done at recent experiments on J-KAREN-P laser facility, following plasma parameters determination using also plasma zones conception, and results. We observed the non-linear growth of X-ray emission from stainless steel plasma. X-ray emission intensity increases by power law with laser intensity on target as $\sim a_0^9$, where a_0 -dimensionless amplitude of laser field. We shown that x-ray emission from stainless steel foils at laser intensity on target $\sim 5 \times 10^{21} \text{ W/cm}^2$ (in average, with fluctuation of 30% (σ)) the matters state with ultra-high energy density $\sim 0.8 \times 10^9 \text{ J/cm}^3$ reached in the laser target interaction region.

Laser-plasma accelerators of high energy electrons

N. E. Andreev^{1,2}

¹ Joint Institute for High Temperatures of the Russian Academy of Sciences, Moscow, Russia;

² Moscow Institute of Physics and Technology, Moscow Region, Russia

e-mail: andreev@ras.ru

Acceleration of electrons to high energies of the TeV range, as well as the creation of compact sources of relativistic electrons and hard X-rays, require the development of advanced acceleration methods with a large acceleration gradient. One of the possible approaches to reach the high energy range of many tens and hundreds of GeV is based on the multistage acceleration of electrons in the wakefields generated in plasma by relativistic-intense femtosecond laser pulses.

As a possible injector for the laser-plasma accelerator, the interaction of a subterawatt laser pulse with a inhomogeneous plasma of a gas jet was investigated. The effective generation of the wake plasma wave was demonstrated, and the capture of background plasma electrons and their further acceleration in the wake field was studied [1]. The capture and acceleration of short electron bunches externally injected into the laser wakefields are investigated. Injection of low-energy bunches allows one to obtain the bunch energy gain to the GeV range with a small energy spread. The influence of the beam loading to the final energy and the energy spread of accelerated electrons are analyzed [2].

The effect of synchrotron radiation on the dynamics of energy gain and the spin precession of a polarized electron beam is investigated in the process of acceleration with a self-consistent description of the nonlinear dynamics of a laser pulse and the generated accelerating and focusing fields of a plasma wake. It was shown that synchrotron radiation hardly affects the energy gain and polarization of electrons, which are accelerated in fields characteristic of a moderately nonlinear mode of laser-plasma acceleration, up to the energy of 4 TeV [3].

An analytical model of the electron beam emittance dynamics has been developed. Matching the beam with the focusing force at the point of injection prevents the growth of the emittance during acceleration [4]. The scheme with a smooth exit from the accelerating stage provides a quasiadiabatic change in the emittance and polarization of the beam.

REFERENCES

- [1] V.S. Popov, N.E. Andreev, *Quantum Electronics* 49, 307-313 (2019).
- [2] N.E. Andreev, V.E. Baranov, H.H. Matevosyan, *Laser & Particle Beams* 35(4), 569-573 (2017).
- [3] D.V. Pugacheva and N.E. Andreev, *Quantum Electronics* 48(4), 291-294 (2018).
- [4] M.E. Veysman, N.E. Andreev, in press (2019).

Compact synchrotron radiation sources on laser plasma interactions

I. A. Andriyash¹

¹ Department of Physics of Complex Systems, Weizmann Institute of Science, Rehovot, Israel
e-mail: igor.andriyash@weizmann.ac.il

Sources of intense beams of energetic radiation and particles are essential tools for research and applications. The synchrotron radiation (SR) sources use the accelerated particle beams to generate X-rays, and the present progress of laser and laser plasma science promises groundbreaking solutions for further development of compact SR sources. The today's plasma accelerators deliver high-current electron beams [1], which have potential to produce the laser-like coherence and high powers of future ultracompact X-ray sources [2]. These applications are now actively explored by the leading research groups worldwide.

This presentation will highlight several recent ideas and results at the frontier of laser, plasma and accelerator science. The discussion will range from the sources of energetic electrons and to the synchrotron radiation driven by lasers and laser plasma. In particular, I will consider the SR source concepts based on the plasma accelerators of electrons, the optical, plasma and magnetic undulators and their combination with the conventional accelerator techniques [3-5].

REFERENCES

- [1] V. Malka, J. Faure, Y. A. Gauduel, E. Lefebvre, A. Rousse, K. Ta Phuoc, *Nat. Phys.*, 4, 447 (2008)
- [2] S. Corde, K. Ta Phuoc, G. Lambert, R. Fitour, V. Malka, A. Rousse, A. Beck E. Lefebvre, *Rev. Mod. Phys.*, 85, No. 1
- [3] I.A. Andriyash, E. d'Humieres, Ph. Balcou, V.T. Tikhonchuk, *Phys. Rev. Lett.* 109, 244802 (2012)
- [4] I.A. Andriyash, R. Lehe, A. Lifschitz, C. Thaury, J.-M. Rax, K. Krushelnik, V. Malka, *Nature Commun*, 5, 4736 (2014)
- [5] T. Andre, I.A. Andriyash, A. Loulergue et al, *Nature Commun* 9, 1334 (2018)

Laser irradiated sub-micro wire and sheet array targets as a source of thermonuclear neutrons

S. G. Bochkarev^{1,2}, A. V. Brantov^{1,2}, D. A. Gozhev^{1,3}, N. A. Busleev¹,
S. I. Kudryashov¹, A. B. Savel'ev³ and V. Yu. Bychenkov^{1,2}

¹ P.N. Lebedev Physical Institute of Russian Academy of Sciences, Moscow, Russia;

² Center for Fundamental and Applied Research, Dukhov Research Institute of Automatics (VNIIA) ROSATOM, Moscow, Russia;

³ M.V.Lomonosov Moscow State University, Moscow, Russia
e-mail: bochkarsg@lebedev.ru

Laser plasma produced by intense ultrashort laser pulses is a source of high energy charged particles and secondary radiation, including gamma rays and neutrons [1]. In this work the scheme is proposed for neutron generation in micro-structured plasma produced by an intense fs laser pulse irradiating a substrate foil coated by deuterated sub-micro-sized sheets and wires. Such target design, which is the arrays of sheets or wires with thickness of hundreds of nm and interspacing distance of the order of one laser wave length ($\sim 1\mu\text{m}$) possess unique characteristics such as high average target density (of the order of 10 percent of solid dense plasma) and high transparency with respect to laser radiation. Micro-scale fusion in a target with dense wire array has been recently demonstrated experimentally with Joule level pulses in Ref. [2], where the maximum yield of DD neutrons per 1 J of laser energy was registered as high as $2 \cdot 10^6$ neutrons/J.

By using 3D PIC simulations, we studied in details and performed optimization of ion acceleration as well as production of thermonuclear neutrons from micro-structured plasma produced by ultrashort pulse of modest intensity ($\geq 10^{18}$ W/cm²). The modest intensity choice corresponds to the energy range of laser accelerated deuterons for which cross-section of DD and DT reactions is close to its maximum values. Thus, the higher intensities are not necessary for effective neutron production. We show that for these innovative targets the neutron yield from $\text{D(d,n)}^3\text{He}$ reaction is order of magnitude higher as compared to the cluster plasma (with the yield of 10^5 neutrons per 1 J [1]). Neutron yield for thermonuclear reactions is of the order of 10^6 and $2 \cdot 10^8$ neutrons/J for micro structured target where deuterium and tritium ions are implanted into pure metal sub-micro-sized surface structures with micro-wires. For optimized micro-sheet targets corresponding yields are $5 \cdot 10^5$ and 10^8 neutrons/J. Despite that the performance of sheet target turns to be lower in comparison to target consisting of the micro-wires, we expect that the last one can also be acceptable for compact neutron sources due to the robustness of technology of sheet structure producing (that is somewhat similar to gratings).

This work was supported by the Russian Science Foundation grant No. 17-12-01283.

REFERENCES

- [1] T. Ditmire et al., *Nature*, 398 489 (1999).
- [2] A. Curtis, et al., *Nature Comm.* 9, 1077 (2018).

Advanced schemes of laser based particle acceleration for radiation-radioactive sources

A. V. Brantov^{1,2}, S. G. Bochkarev^{1,2} and V. Yu. Bychenkov^{1,2}

¹ P.N. Lebedev Physical Institute of Russian Academy of Sciences, Moscow, Russia;

² Center for Fundamental and Applied Research, Dukhov Research Institute of Automatics (VNIIA) ROSATOM, Moscow, Russia

e-mail: brantov@lebedev.ru

In this report we present several schemes for laser-targets interaction to enhance a number of accelerated electrons from the targets of near-critical density, to create effective source of hot deuterons/tritons in the micro-structured target of sub-solid density for neutron production from thermonuclear reactions, and to significantly increase electron temperature in clustered plasma for bright X-ray source. Based on 3D PIC simulation the optimal regime of laser pulse propagation, “laser bullet“ [1], in near-critical density target is studied in details. This regime provides generation of electron beam with maximum charge in the multi-MeV energy range. Such electron beam is effectively converted to gamma-radiation via bremsstrahlung mechanism and produces electron-positron pairs or even elementary particles: (π^+, π^-, π^0) - pions and muon pairs. The optimized structure of micro-cylinders on the irradiated target side results in maximum electron temperature and effective ion (proton/deuteron) acceleration to enhance neutron production. The effectively stochastically heated cluster plasma in hohlraum geometry is shown to be a bright source of X-ray and gamma emission as well as a neutron source. The wire targets has been studied as transmission line for both laser triggered electron bunches and THz pulses.

This work was supported by the Russian Science Foundation (Grant No. 17-12-01283).

REFERENCES

[1] M.G. Lobok et al. Plasma Phys. Control. Fusion 60 084010(2018).

Action of an orbital angular momentum laser beam on dilute plasma

R. Nuter¹, E. Dmitriev², Ph. Korneev^{2,3}, and V. Tikhonchuk¹

¹ CELIA, University of Bordeaux, CNRS, CEA, France;

² National Research Nuclear University MEPhI, Moscow, Russian Federation;

³ Lebedev Physical Institute of the Russian Academy of Sciences

e-mail: eggor@bk.ru

One of the powerful ways for controlling properties of dilute plasma is its irradiation by structured laser beams. It appears possible to produce certain spatial distribution of density and temperature, as well as magnetic field generation [1]. Such plasma structures are interesting in many laser-based applications, including particle acceleration, radiation generation and fundamental studies.

Collective effects usually play crucial role in such interaction, but single particle effects in some situations are of a primary importance. Numerical simulations [1] modelling the interaction of a laser pulse carrying an orbital angular momentum with a dilute plasma show magnetized plasma cloud. The magnetic field is directed along the laser propagation axis, which means that it is caused by the rotation of charged particles, which absorb part of the laser orbital angular momentum. It was confirmed with test particle simulations, that the process can be considered as a single-particle – wave coupling.

The numerical algorithm, used in [1], allows to prescribe electromagnetic fields, which are solutions of Maxwell equations. However analytically, the fields are defined rather phenomenologically. For a complete consistent explanation of the process of OAM transfer analytic solution for the fields is required. To develop a theoretical model, in paraxial approximation, structured laser beams may be described in terms of Laguerre-Gaussian modes [2], which form a complete basis in this approach. Within this description, a perturbation theory was developed, which holds for individual wave-particle coupling. It is seen, that the spatial field dependences do not allow to conserve the whole set of the integrals of motion, which are known to survive in a plane wave. This is an important difference, which leads to OAM absorption for individual electrons. However, for uniform plasma distribution, a symmetry in angular position results in a zero net electron rotation. Thus, further analysis is performed for the understanding of the coupling mechanisms in more details.

REFERENCES

[1] Nuter, R., Korneev, P., Thiele, I. and Tikhonchuk, V., *Physical Review E* 98(3), 033211 (2018).

[2] L. Allen, M. W. Beijersbergen, R. J. C. Spreeuw, and J. P. Woerdman, *Physical Review A* 45 (11), 8185 (1992)

Plasma collapse in electron-positron pair generation by extreme laser fields

E. S. Efimenko¹, A. V. Bashinov¹, A. A. Muraviev¹ and A. V. Kim¹

¹Institute of Applied Physics, Russian Academy of Sciences, Nizhny Novgorod, Russia;
e-mail: evgeny.efimenko@gmail.com

Coming 10PW-class lasers in the near future are able to explode the vacuum giving rise a dense electron-positron plasma, i.e. to create a dense matter in the vacuum by means of light. In this report, we will discuss how extremely dense pair plasma can be obtained with high intensity lasers. We consider in detail the production of a quantum electromagnetic cascade and the dynamics of an electron-positron plasma in ultimately focused laser beams of extreme intensity [1]. We pay particular attention to the new regime of laser-plasma interactions, so-called high-current plasma pinching, which allows to achieve extreme plasma parameters and electromagnetic fields. The plasma self-compression in this case leads to an abrupt rise of the peak pair density and magnetic (electric) field up to at least 10^{28}cm^{-3} and $1/20$ ($1/40$) of the Schwinger field, respectively. Determining the actual limits and physics of this process might require quantum treatment beyond the used standard semiclassical approach. The proposed setup can thus provide extreme conditions for probing and exploring fundamental physics of the matter and vacuum [2].

REFERENCES

- [1] E.S. Efimenko et al., Scientific Reports 8, 2329 (2018).
- [2] E.S. Efimenko et al., Phys. Rev. E 99, 031201(R) (2019).

Ion acceleration assisted by radiation reaction

E. G. Gelfer^{1,2}, A. M. Fedotov², and S. A. Weber¹

¹ELI Beamlines, Institute of Physics of the ASCR, v.v.i., Dolni Brezany, Czech Republic

²National Research Nuclear University “MEPhI”, Moscow, Russia;

e-mail: am_fedotov@mail.ru

A number of multi-petawatt laser facilities is now under construction around the globe. As expected, by using tight focusing close to diffraction limit, they will be capable of delivering ultraintense ($I > 10^{23}$ W/cm²) laser pulses. Among their announced applications perhaps the most promising one is ion acceleration in a plasma [1,2]. At such intensity level electron motion, and hence, at first sight, any process of laser-matter interaction, has to be strongly perturbed by radiation reaction. But all the conventional scenarios of laser-plasma ion acceleration are entirely based on irradiation of opaque targets. In such a case only a small fraction of electrons could ever probe the strong field region, hence radiation reaction might have only a weak influence on a process [3]. However, if a target is transparent to a strong laser pulse then radiation reaction effect on plasma electrons can be crucial. In particular, by modifying quiver electron motion, radiation friction can strongly enhance the longitudinal charge separation field [4,5], thus stimulating ion acceleration.

We present a model and an overview of simulation results for laser-plasma ion acceleration assisted by radiation reaction in an underdense plasma and study the scaling of the maximal attainable ion energy with the laser and target parameters. We also study the performance of the novel mechanism with respect to the conventional ones.

REFERENCES

- [1] S.C. Wilks et. al., PRL 69, 1383-1386 (1992).
- [2] T. Esirkepov et. al. PRL 92, 175003 (2004).
- [3] M. Tamburini et. al., NJP 12, 123005 (2010).
- [4] E. Gelfer, N. Elkina, A. Fedotov, Scientific Reports 8, 6478 (2018).
- [5] E.G. Gelfer, A.M. Fedotov, S. Weber, PPCF 60, 064005 (2018).

Highly efficient electron acceleration in plasma waveguide driven by tightly focused low power laser

Jie Feng^{1,2}, Jinguang Wang¹, Xiaotao Geng¹, Yifei Li¹, Dazhang Li^{1,5} and Liming Chen^{1,2,3,4}

¹ Beijing National research center of Condensed Matter Physics, Institute of Physics, CAS, Beijing, China;

² University of Chinese Academy of Sciences, Beijing, China;

³ Songshan Lake Materials Laboratory, Dongguan, China;

⁴ IFSA Collaborative Innovation Center and School of Physics and Astronomy, Shanghai Jiao Tong University, Shanghai, China;

⁵ Institute of High Energy Physics, CAS, Beijing, China;

e-mail: fengjie@iphy.ac.cn

Several hundred MeV electron beam with high repetition rate is hard to be generated by laser wakefield acceleration, due to the single shot energy of high repetition rate (kHz) laser facility is limited to tens of mJ. However, our simulation results demonstrate that the electron beam energy could be up to ~ 100 MeV scale in the regime of ionization injection driven by a tightly focused 0.8 TW 24 mJ laser pulse propagation in a plasma waveguide. The conversion efficiency is about two orders of magnitude higher than the uniform plasma case. This simulation results could provide a promise way to accelerate electron beam to hundred MeV by utilizing a low power and high repetition rate laser facility.

Absorption and opacity threshold of a thin foil in a strong laser field

E. G. Gelfer^{1,2}, A. M. Fedotov², O. Klimo^{1,3} and S. A. Weber¹

¹ELI Beamlines, Institute of Physics of the ASCR, v.v.i., Dolni Brezany, Czech Republic

²National Research Nuclear University “MEPhI“, Moscow, Russia;

³FNSPE, Czech Technical University in Prague, Czech Republic

e-mail: egelfer@gmail.com

We investigate the conditions for the transparency of a thin foil submitted to a strong circularly polarized laser radiation. We develop a model for the process of laser–foil interaction, which takes laser absorption into account, and derive a scaling of the transparency threshold with laser and target parameters. The model is confirmed by PIC simulations and predicts that in the ultrarelativistic regime the threshold areal density of the target depends on laser temporal profile and ion charge to mass ratio rather than on the laser field amplitude. In particular, relativistic self-induced transparency can be achieved with shorter pulses for smaller areal density of the target. Interaction with an opaque foil leads to the steepening of the laser pulse front, and this effect can be important for applications, such as laser particle acceleration.

Investigation of near threshold photonuclear reactions by electron bunch from relativistic laser-solid interaction

D. A. Gorlova^{1,2}, I. N. Tsymbalov^{1,2}, A. Yu. Zavorotniy¹, K. A. Ivanov^{1,3},
S. A. Shulyapov¹, V. G. Nedorezov² and A. B. Savel'ev^{1,3}

¹ Faculty of Physics and International Laser Center, M.V. Lomonosov Moscow State University, Moscow, Russia;

² Institute for Nuclear Research of the Russian Academy of Sciences, Moscow, Russia;

³ P.N. Lebedev Physical Institute of the Russian Academy of Sciences, Moscow, Russia
e-mail: gorlova.da14@physics.msu.ru

The generation of the electron bunches with high energy and charge in the laser-plasma interactions can occur due to various mechanisms of laser acceleration. In terawatt femtosecond laser facility at MSU we can obtain electron beam with energies up to 10 MeV and charge ~ 30 pC by interaction of femtosecond laser radiation with intensity up to 5×10^{18} W/cm² with dense plasma, formed by additional nanosecond prepulse with controlled parameters [1]. Choosing appropriate parameters of main laser pulse and artificial prepulse we can change interaction regimes and thereby optimize beam parameters for different applications.

One of the interesting applications for our beam is studying near threshold (photon energies below 10 MeV) photonuclear reactions. This research can lead to some significant results: for example, it can promote the development of microscopic nuclear models. Another important issue is to create laboratory-scale sources of particles such as electrons, positrons, neutrons, protons.

In this work we'll discuss a possibility of creating a neutron source based on our terawatt femtosecond laser system using (γ, n) reactions in beryllium and deuterium. A flux of low energy neutrons up to $10^4 s^{-1}$ was obtained experimentally with 10 Hz repetition rate. We also studied photoexcitation of spin isomers of In and Cd nuclei in the pigmy resonance region both on electron linear accelerator LUE-8 MeV at INR and MSU laser facility [2]. Results on positron generation will also be discussed.

This work was supported by RFBR grants 19-020-00104 and 18-32-00416 mol-a. D. A. Gorlova acknowledges Foundation for the advancement of theoretical physics "BASIS" for the financial support.

REFERENCES

- [1] I.N. Tsymbalov et.al., accepted to PPaCF (2019).
- [2] V. Nedorezov et.al., Phys. Scr. 94, 01530 (2019).

Studying the dynamics of laser-plasma interaction on solid targets by femtosecond interferometry

G. A. Gospodinov¹, K. A. Ivanov^{1,2} and A. B. Savel'ev¹

¹ Department of Physics, M.V. Lomonosov Moscow State University, Moscow, Russia;

² P.N. Lebedev Physics Institute, Russian Academy of Sciences, Moscow, Russia;

e-mail: ga.gospodinov@physics.msu.ru

The efficiency of hot electrons production in the regime of laser-plasma interaction with plasma wave formation is strongly affected by such parameters as the spatial scale, profile, density of the pre-plasma, which is induced by the pre-heating laser pulse [1, 2].

In this work we present experimental research of the interaction of a slightly relativistic femtosecond laser pulse (Ti:Sapphire laser, central wavelength - 800 nm, pulse duration - 55 fs, on-target intensity $\sim 10^{18}$ W/cm²) with a controlled pre-plasma that was created by a nanosecond laser pulse (Nd:YAG laser, central wavelength - 1064 nm, pulse duration - 6 ns, on-target intensity $\sim 10^{11}$ W/cm²) on solid targets. The plasma density dynamics depending on the angle of incidence of the heating radiation, as well as on the time delay between nanosecond and femtosecond pulses was investigated by femtosecond interferometry.

This work was supported by the Russian Foundation for Basic Research (Grant Nos 18-32-00416 and 19-02-00104).

REFERENCES

- [1] R. Nuter, L. Gremillet, P. Combis et al. , Journal of Applied Physics 104, 103307 (2008)
- [2] K. A. Ivanov, I. N. Tsymbalov, S. A. Shulyapov et al., Physics of Plasmas 24, 063109 (2017)

Stochastic electron heating in laser irradiated micro-wire target and its optimization for the highest temperature

D. A. Gozhev¹, S. G. Bochkarev¹, A. V. Brantov¹, V. Yu. Bychenkov¹ and
A. B. Savel'ev²

¹ P.N.Lebedev Physical Institute of RAS, Moscow, Russia;

² M.V.Lomonosov Moscow State University, Moscow, Russia

e-mail: gozhevda@lebedev.ru

Laser-driven charge particle acceleration and secondary radiation generation is a topic of great interest for fundamental research and possible applications in nuclear physics, radiography, nuclear medicine and nuclear pharmacology, laboratory astrophysics and extreme states of matter. Micro structured targets possess unique characteristics due to the possibility of effective volumetric absorption of laser energy and high conversion of laser radiation to charged particles and secondary electromagnetic and corpuscular emission.

In this work, with the help of 3D PIC simulations, we have examined the interaction of ultrashort laser pulse of moderate intensity ($> 10^{18}\text{W}/\text{cm}^2$) with innovative high-average-density targets with artificial substrate coating consisting of numerous sub-micron-wires and sheets at the surface of a target. We fulfilled geometrical optimization of such targets to increase absorption of laser light and energy (temperature) and number of hot electrons. Two mechanisms providing absorption have been previously noted: vacuum heating/direct laser acceleration. We believe that more complicated scenario of laser light absorption takes place because of effective energy transfer to high-energy electrons due to their stochastic heating in complex high-frequency and quasistationary electric and magnetic fields. In our simulation a laser pulse of the intensity $2 \times 10^{18}\text{W}/\text{cm}^2$ and duration $\tau_L = 50$ was focused into focal spot of 2λ diameter (FWHM), where $\lambda = 1\mu\text{m}$ was chosen for the laser wavelength. We modeled a target structure as cylinders placed on an irradiated flat target surface along laser propagation direction. The electron density of wires and sheets were $n_e = 50n_{cr}$ where n_{cr} is the critical density of plasma. Absorption takes place in a skin layer of the wires and in the interspace electron gas. We optimized parameters of the micro-structures, such as their thickness, distance between them and their height. The optimal distance between the structures is dictated by the fact that, on the one hand, the laser radiation should well penetrate between structures, and, on the other hand, the average target density should be as high as possible to be efficient for nuclear applications. The optimal wire (sheet) height is equal to $h_{opt} \simeq c\tau_L/2$, that enables interaction of incident and reflected light to heat electrons efficiently. In this case, the laser pulse penetrates into a target, reflects from the wires and substrate foil, and get well absorbed on the way back to the vacuum region. This absorption is due to the heating of considerable number of

electrons to high temperature. As a result, the average energy of hot electrons increases from 70 keV (flat target) to 350 keV (the optimized structured target). Similar simulations were carried out for laser-plasma interaction with sub-micro sheets. Simulations show that, despite of the average energy of fast electrons for sheet target (270 keV) is some less than the energy from wires, this energy is still much more than electron energy from flat target. In addition, it should be noted that the technology for producing the micro-sheet targets is simpler than that with wires.

To explain generation of super-ponderomotive electrons (with energies significantly larger than the ponderomotive energy) we apply test particle approach and methods of stochastic dynamics. We model electron dynamics in complex EM field consisting of incident and reflected wave, Coulomb field of charge separation at plasma-vacuum boundaries and quasistatic magnetic field. We show stochastic nature of producing of high energy electrons in complex EM field with the help of largest Lyapunov's exponent analysis.

This work was supported by RFBR (grants 18-32-00406, 18-02-00452, and 17-02-00366).

Surface and volume sub- λ scale structured targets for efficient generation of ionizing radiation for applications at relativistic ultrashort laser-plasma interaction

K. Ivanov^{1,2}, N. Sukhanov¹, D. Gozhev^{1,2}, I. Gavrilin³, I. Mordvintsev¹,
I. Tsymbalov¹, D. Gorlova¹, Yu. Kargina¹, Yu. Nazarkina³, S. Rodichkina¹,
R. Volkov¹, S. Gavrilov³, V. Bychenkov² and A. Savel'ev¹

¹ M.V. Lomonosov Moscow State University, Moscow, Russia;

² P.N. Lebedev Physical Institute of Russian Academy of Sciences, Moscow, Russia;

³ National Research University of Electronic Technology, Zelenograd, Russia

e-mail: akvonavi@gmail.com

We present results on acceleration of charged particles and generation of hard X-rays at interaction of relativistic femtosecond laser pulse with various types volume and surface structured targets produced via chemical etching, deposition, lithography using metal, semiconductor and organic substrate. The laser pulse was delivered by Ti:Sa laser system (50 fs, 100 mJ, 800 nm, 10 Hz, ASE contrast $> 10^9$, $I_{peak} > 10^{18}$ W/cm²). An artificial nanosecond prepulse could be introduced (100 mJ, 10 ns) in order to ionize the medium and form a low density plasma.

The optical damage threshold (melting and ablation) of targets was investigated to inspect the influence of the naturally limited contrast of the laser system. We found that the threshold for structured targets is decreased compared to flat and moreover it varies with the production method.

It is demonstrated, that at the interaction of the laser radiation with spatially modified targets contributes to the generation of rather collimated MeV electron beam along the laser propagation direction. The energy, charge and divergence of this bunch may be improved if the target is preionized with the use of the artificial prepulse. At the same time the high photon flux is suppressed at these targets due to lower density. Bright X-rays and gammas are obtained at the interaction with surface structured targets. The accelerated electrons at the front surface of the target penetrate into the bulk substrate generating bremsstrahlung.

According to the numerical simulations of laser-plasma interaction using PIC code Mandor in the case of ionized preplasma formed by the prepulse the particles are accelerated at the wavebreaking of plasma oscillations excited by parametrical processes and subsequent energy gain in the field of reflected laser radiation. During the interaction with nanostructures onto the surface of solid targets the complex field of ionized structures, incident and reflected laser beam contribute to the stochastic heating of electrons to final energies, exceeding the ponderomotive potential.

This work was supported by RSCF grants N 17-12-01283 (the part concerning the interaction with organic and deposited targets) and N 18-79-10160 (the results on damage threshold and targets produced via electrochemical etching, lithography).

Diagnosics of spontaneous magnetic fields in capacitor-coil targets

T. Pisarczyk¹, J. J. Santos², R. Dudzak^{3,4}, A. Zaráś-Szydłowska¹, M. Ehret^{1,5},
 Z. Rusiniak¹, J. Dostal^{4,3}, T. Chodukowski¹, Yu. Kochetkov⁷, Ch. Vlachos^{2,9},
 O. Renner^{3,4}, Yu. Gus'kov^{6,7}, Ph. Korneev^{7,6}, T. Burian^{3,4}, M. Kalal^{8,4},
 M. Krupka^{4,3,8}, M. Pfeifer^{3,4}, J. Krasa^{3,4}, S. Borodziuk¹, M. Krus⁴, L. Juha^{3,4},
 J. Hrebicek^{3,4}, J. Golasowski^{3,4} and J. Skala^{3,4}.

¹Institute of Plasma Physics and Laser Microfusion, Warsaw, Poland

²Univ. Bordeaux, CNRS, CEA, CELIA, UMR 5107, Talence, France

³Institute of Physics, Czech Academy of Sciences, Prague, Czech Republic

⁴Institute of Plasma Physics, Czech Academy of Sciences, Prague, Czech Republic

⁵Institut für Kernphysik, Technische Universität Darmstadt, Darmstadt, Germany

⁶P.N. Lebedev Physical Institute of RAS, Moscow, Russian Federation

⁷National Research Nuclear University MEPhI, Moscow, Russian Federation

⁸Czech Technical University, Prague, Czech Republic

⁹Centre for Plasma Physics & Lasers, T.E.I. of Crete, Rethymnon, Greece

e-mail: greydrago@mail.ru

Laser-driven magnetic field generation is a subject of particular interest both as a special physical phenomenon and as a necessary part of astrophysical studies in laboratory, magnetized solutions of Inertial Confinement Fusion and of many others applications. Thus one of the challenges of modern physics is the creation of open-geometry platform for the generation of strong quasi-static magnetic fields. Usage of capacitor-coil targets (CCT) irradiated by a powerful laser is one of the most promising approaches. Magnetic field generation is caused by strong discharge currents and strongly depends on the target geometry.

To optimize the performance of such an approach, information about the generated field by the coil and about the current density distributions in the laser-irradiated capacitor part of the target may be very useful. Estimation of current density in the ablative plasma between the CCT-plates is attainable by space-time measurement of the spontaneous magnetic field in that region. It can be accurately and reliably carried out using complex interferometry, a development of standard methods of interferometry and polarimetry, performed recently at PALS [1,2]. The interferogram obtained using this method contains both information about the plasma electron density (interference pattern) and the probe laser's polarization plane rotation (intensity modulation).

Experimental data, obtained at PALS facility using the unique 3-frame complex-interferometry [3] system, show a very strong current in the capacitor region, comparable to that expected in the coil part of the target. The correlation between these two currents is carefully studied. The analysis allows defining further steps for optimization of the CCT performance and maximize the B-field in the coil.

REFERENCES

[1] T. Pisarczyk, Yu. Gus'kov, R. Dudzak et al. *Physics of Plasmas* 22(10),

102706 (2015).

[2] T. Pisarczyk, Yu. Gus'kov, T. Chodukowski et al. *Physics of Plasmas* 24(10), 102711 (2017).

[3] A. Zaras-Szydłowska, T. Pisarczyk, T. Chodukowski et al. Complex interferometry application for spontaneous magnetic field determination in laser-produced plasma. Poster: P5.214, 44th European Physical Society Conference on Plasma Physics, 26-30 June 2017, Belfast.

Kinetic plasma waves carrying orbital angular momentum

D. Blackman¹, R. Nuter¹, Ph. Korneev^{2,3} and V. Tikhonchuk^{1,4}

¹CELIA, University of Bordeaux, CNRS, CEA, 33405 Talence, France

²National Research Nuclear University "MEPhI" , Moscow, Russian Federation

³P. N. Lebedev Physics Institute, Russian Academy of Sciences, Moscow, Russian Federation

⁴ELI-Beamlines, Institute of Physics, Czech Academy of Sciences, Dolni Brezany, Czech Republic
e-mail: ph.korneev@gmail.com

It was discussed in literature, that electromagnetic waves may carry orbital angular momentum (OAM), while propagating in vacuum. It was also found, that this OAM may be transferred to particles if the wave is absorbed [1]. This feature is quite interesting for various applications in optics for compact storing of information, nanoscale imaging and manipulation. Mathematically, in a certain approximation, such beams are presented with Laguerre-Gaussian functions, which are eigenmodels of the paraxial optics equation in the cylindrical coordinates. Applications of OAM modes in the physics of laser plasma interaction are not yet considered, although recent publications show their potential for particle focusing and acceleration, generation of strong plasma waves and quasistatic magnetic fields.

In plasma waves, a similar feature may be found. In this work, the structure of Langmuir plasma waves carrying a finite angular orbital momentum is revised in the paraxial approximation. It is shown that the kinetic effects related to higher order momenta of the electron distribution function lead to coupling of Laguerre-Gaussian modes and result in modification of the wave dispersion and damping. The theoretical analysis is compared to the three-dimensional particle-in-cell numerical simulations for a mode with definite orbital momenta. It is demonstrated that propagation of such plasma wave is accompanied with generation of a quasistatic axial and azimuthal magnetic fields which are consequence of the longitudinal and orbital momentum transported with the wave. A ratio between the azimuthal and axial components can be controlled by appropriate choice of amplitudes and momenta of two oppositely propagating waves. Linear damping of such plasma waves is accompanied with persistence of these magnetic fields which due to the momentum transfer from the wave to the resonant particles.

REFERENCES

- [1] Nuter, R. Korneev, Ph. Thiele, I. Tikhonchuk, V., Physical Review E, 98 (3), 033211 (2018).
- [2] Blackman, D., Nuter, R., Korneev, Ph., Tikhonchuk, V. T., ArXiv 1903.08955 (2019).

Highly efficient generation of mid-IR radiation in back-reflection of ultra-intense laser pulse from near-critical density plasmas

A. V. Korzhimanov^{1,2}, N. A. Mikheytssev^{1,2}

¹ Federal Research Center Institute of Applied Physics of the Russian Academy of Sciences, Nizhny Novgorod, Russian Federation;

² Lobachevsky State University of Nizhny Novgorod, Nizhny Novgorod, Russian Federation
e-mail: kav@ufp.appl.sci-nnov.ru

Recently, a significant progress in the development of intense sources of mid-infrared pulses opened up many opportunities in the field of infrared spectroscopy [1] and the generation of intense X-ray pulses [2]. In this work, we propose a highly efficient scheme for mid-IR radiation generation of high intensity based on back-reflection of an ultrashort optical or near-IR laser pulse from a sharp boundary of overdense plasmas. One of the advantages of this scheme is an absence of limitations on a power of the irradiating pulse, which makes it possible to obtain relativistically intense pulses with a wavelength in the range from 2 to 10 μm .

The normal irradiation of an overdense plasma slab by a relativistically intense laser pulse was investigated. Due to a radiation pressure of the laser light electrons were observed to be pulled inward the target at the speed close to the light speed which provided a significant red-shifting of the reflected signal.

Based on an analytical description proposed in [3] and 1D and 2D numerical simulations, it was shown that the maximum generation efficiency is reached in the case of a circularly polarized incident pulse with an extremely sharp leading-front boundary interacting with a near-critical density plasmas. In particular, at the incident intensity of the order of $3 \times 10^{21} \text{ W/cm}^2$ it was shown that more than 3% of the incident energy can be converted to the radiation in the range of 3-8 μm . In the case of linearly polarized radiation and pulses with smoother envelope, the efficiency is lower but still at the level of few tenths of percent.

REFERENCES

- [1] C. Calabrese et al., *Opt. Lett.* 37, 2265-2267 (2012).
- [2] T. Popmintchev et al., *Science* 336, 1287-1291 (2012).
- [3] A. Gonoskov et. al., *Phys. Rev. E* 84, 046403 (2011).

Hard X-rays generation by hot electrons in metal targets

O. F. Kostenko

Joint Institute for High Temperatures of the Russian Academy of Sciences, Moscow, Russia
e-mail: olegkost@ihed.ras.ru

To radiograph substances with a high energy density, use is made of X-rays in the 10–100 keV range. Radiographing the dense plasma which is to be produced by heavy ion beams on the FAIR under construction calls for X-rays with photon energies above 100 keV.

In Ref. [1] we determined the hot-electron energy distribution function by modelling the data of bremsstrahlung and K_α radiation measurements for silver targets with no recirculation of hot electrons, which were produced by s-polarised subpicosecond laser pulses of peak intensity 2×10^{19} W/cm² on the PHELIX laser facility. In the present work, we consider a semi-analytical model of X-ray bremsstrahlung generation in metallic targets with the inclusion of hot electron recirculation [2]. The hard X-ray bremsstrahlung and characteristic radiation yields were calculated in relation to the thickness of a silver target.

The effect of hot electron recirculation in thin foils was shown to significantly improve the K_α radiation and bremsstrahlung yields in the 10–100 keV photon energy range. By contrast, the bremsstrahlung photon yield in the 0.1–1 MeV energy range from 10–20 μ m thick foils, in which the hot electrons recirculate, corresponds approximately to the photon yield from the rear sides of 1–2 mm thick targets, in which the recirculation is insignificant. The laser-to- K_α radiation energy conversion coefficient and the spectral contrast of the K_α radiation with the use of a 10- μ m thick silver foil, in which the recirculation is implemented, are consistent with the data obtained on the Titan laser facility [3]. When use is made of the specified target, the laser to 0.1–1 MeV bremsstrahlung energy conversion efficiency is 4×10^{-4} . For such coefficient it is possible to obtain high-quality radiographic images of millimetre-sized lead samples heated by heavy ion beams to a high energy density state [4]. The prospect of obtaining by an order of magnitude greater conversion efficiency of laser energy into bremsstrahlung energy in the range of 0.1–1 MeV is indicated when using a layered target consisting of aluminum and silver foils, in which hot electrons are recirculated.

REFERENCES

- [1] O.F. Kostenko, N.E. Andreev, O.N. Rosmej, *Phys. Plasmas*, 25 (3), 033105 (2018).
- [2] O.F. Kostenko, *Quantum Electronics*, 49 (3), 216 (2019).
- [3] B. Westover, A. MacPhee, C. Chen, et al, *Phys. Plasmas*, 17 (8), 082703 (2010).
- [4] K. Li, B. Borm, F. Hug, et al, *Laser Part. Beams*, 32 (4), 631 (2014).

XCELS project: new source of extreme light, unique physics and applications

I. Yu. Kostyukov¹

¹ Institute of Applied Physics of Russian Academy of Sciences, 603950, Nizhny Novgorod, Russia;
e-mail: kost@appl.sci-nnov.ru

The goal of the XCELS project in Russia is establishing a large research infrastructure – the Exawatt Center for Extreme Light Studies [1]. The core of the planned infrastructure will be a new unique source of light having the power of about 0.2 Exawatt. This source constitutes a 12 channel x 15 PW laser system based on technique of optical parametric chirped pulse amplification (OPCPA). The fundamental processes of laser-matter interaction at Exawatt power belong to an absolutely new branch of science that will be the principal research task of the infrastructure. There will open up opportunities for studying the space-time structure of vacuum, nonlinear QED phenomena and unknown processes at the interface of the high-energy physics and the high-field physics. The envisaged applications of results of these studies will include among others development of compact high-gradient charged-particle accelerators, creation of sources of ultrashort pulses of hard X-ray and gamma radiation for diagnosing materials with unprecedented spatial and temporal resolution, elaboration of new sources of radiation and particles for clinical applications.

REFERENCES

[1] A. Shaykin, I. Kostyukov, A. Sergeev, E. Khazanov, *Rev. Laser Eng.* 42, 141 (2014).

Terahertz and infrared pulses generated by a laser wakefield

V. V. Kulagin^{1,2}, V. A. Cherepenin² and V. N. Kornienko²

¹Sternberg Astronomical Institute of Lomonosov Moscow State University, Moscow, Russia;

²Kotel'nikov Institute of Radio-engineering and Electronics of RAS, Moscow, Russia

e-mail: victorvkulagin@yandex.ru

Laser pulse propagating in an underdense plasma produces a wakefield which can be used for acceleration of trapped electrons. Also, during the wakefield formation, strong nonlinear currents are generated in plasma. Emission of intense electromagnetic radiation by these nonlinear currents is studied by 2D particle-in-cell simulation. It is shown that, depending on parameters of the laser pulse and plasma, waves of different frequencies can be generated and they propagate with different angles with respect to the laser axis. In simulations, relatively long pulses (containing many periods) of radiation with single, double and triple plasma frequency were observed so the terahertz and infrared bands can be covered by this source. The influence of a plasma density modulation on the process of emission of plasma frequency harmonics is also investigated. In this case, the amplitude of the generated radiation can be considerably increased. Characteristics of radiation generated during laser wakefield propagation in plasma such as polarization, frequency, amplitude, etc. are studied and spectral densities for different harmonics of the plasma frequency are found. It is shown that the amplitude of the radiation can be about 20 GV/m and efficiency of generation can achieve a percent. Also, an analytical model is considered for generation of terahertz or infrared radiation produced with a wakefield formed by a high-intensity laser pulse in a gas medium.

This work was partially supported by the Russian Foundation for Basic Research project 19-52-45035-Ind-a.

Intense laser plasma interaction as a source of strong terahertz electromagnetic wave

A. S. Kuratov^{1,2}, A. V. Brantov^{1,2}, Yu. M. Aliev² and V. Yu. Bychenkov^{1,2}

¹ Center of Fundamental and Applied Research, VNIIA, Moscow, Russia;

² Lebedev Physical Institute RAS Moscow, Russia;

e-mail: kuratov.andrew@gmail.com

The THz emission via intense laser-plasma interaction is a process which is still not entirely understood. High power THz pulses have specific application capabilities. Laser - plasma interaction has advantages over other methods for high power THz generation.

There are various theories with attempts to explain processes behind THz generation through an interaction of high power laser with solid targets [1]. In this work we theoretically cover some phenomena which responsible for THz generation. Several mechanisms of generation of the THz pulses have been proposed. We report theoretical and numerical comparison of three different mechanisms of THz radiation generation. There are radiation generation during sheath acceleration process at the target rear surface, THz emission by electrical current of fast electrons escaping a target and its generation by thermoelectric currents [2,3].

The THz radiations produced by the mechanisms were theoretically studied. An efficiency of THz generation as a result of plasma expansion into vacuum is always much less than the efficiency of THz generation due to the emission of fast electron beams. It is found angular directions of the generated radiation. If the fast electron beam causes an appearance of radiation directed along the beam axis, the radiation associated with the plasma expansion into vacuum is directed generally along the target surface [2].

We have compared energetic characteristic of a surface electromagnetic wave excited by laser-induced thermoelectric currents with surface wave produced by a beam of electrons leaving the target. With respect to the total radiation energy for typical parameters of relativistically intense short laser pulses, the above mechanism turns out to be comparable in efficiency [3].

REFERENCES

- [1] Herzer S. et al. *New J. Phys.* vol. 20, 063019 pp. 1-15, 2018.
- [2] Kuratov A., Brantov V., Aliev Yu., Bychenkov V. *Quantum Electronics.* vol. 46, pp. 1023-1030, 2016.
- [3] Kuratov A., Brantov V., Aliev Yu., Bychenkov V. *Quantum Electronics.* vol. 48, pp. 653-657, 2018.

Physical mechanism of electron bunch generation by an ultrarelativistic-intensity laser pulse passing through a sharp plasma boundary

S. V. Kuznetsov¹

¹ Joint Institute for High Temperatures of RAS, Moscow, Russia
e-mail: shenau@rambler.ru

The physical mechanism of the generation of electron bunches in the interaction of a laser pulse of ultrarelativistic intensity with semi-bounded plasma having a sharp boundary is studied in one-dimensional geometry [1].

It is revealed that the total charge of the electron bunch is formed of two different groups of electrons. One group consists of electrons that do not cross the boundary of ion background in the process of their motion. The electrons of the other group cross the plasma ion background boundary and return. It is found that independent of the degree of the total electron oscillation energy excess over the threshold value, the bunch formation always begins from the electron initially located at the distance from the ion background boundary equal to the amplitude of its oscillations, caused by the subsequent interaction with the laser pulse.

The main contribution to the bunch charge, particularly in the case of small excess over the threshold, comes from the electrons that do not cross the boundary of the ion background in the process of their motion. The mechanism of their accumulation in the bunch generated by the laser pulse implies that the self-injection of every electron from this group into the wake wave occurs at the time moment and space point, where the earlier injected electrons composing the bunch already are.

The electrons that move beyond the ion background because of interaction with the laser pulse make the most considerable contribution when the process of electron bunch generation is characterized by large excess over the threshold. The mechanism of their accumulation into the bunch is such that after the return into the region of ion background these electrons move with greater velocities and overtake the bunch.

It is derived a formula that determines the bunch charge per unit of its cross section area. It is determined by the thickness of the unperturbed plasma layer, the electrons from which form the generated electron bunch. It is established that the charge accumulated in the bunch is completely determined by two parameters: the energy of the longitudinal oscillations of electrons and the gamma-factor of the laser pulse wake wave.

REFERENCES

[1] S.V. Kuznetsov, *Quantum Electronics*, 48, 945 (2018).

Betatron radiation of high brightness from electron acceleration in the regime of laser bullet

M. G. Lobok^{1,2}, I. A. Andriyash³, V. Malka^{3,4}, V. Yu. Bychenkov^{1,2}

¹ P. N. Lebedev Physics Institute, Russian Academy of Science, Leninskii Prospect 53, Moscow 119991, Russia;

² Center for Fundamental and Applied Research, Dukhov Research Institute of Automatics (VNIIA), Moscow 127055, Russia ;

³ Department of Physics and Complex Systems, Weizmann Institute of Science, Rehovot 76100, Israel;

³ Laboratoire d'Optique Appliquée, ENSTA-CNRS-Ecole Polytechnique, UMR7639, 91761 Palaiseau, France

e-mail: mglobok@me.com

Short laser pulse interaction with a rather dense gas plasma target may result in pulse propagation regime which maximize the charge of the high-energy electron bunches. This regime corresponds to laser pulse propagation in a self-trapping mode, where the diffraction divergence is balanced by the relativistic nonlinearity, so that the laser beam radius stays unchanged during pulse propagation over many Rayleigh lengths. Such regime occurs for near critical density where the pulse length exceeds both the plasma wavelength and the pulse width. Electron acceleration occurs in a travelling cavity with a high-frequency laser field filling and a longitudinal electrostatic single-cycle field (“light bullet”). High charge of accelerated electrons enables efficiently produce X-rays through betatron oscillations. This was demonstrated by using the 3D PIC simulation results for electron characteristics. It has been shown that 100 TW laser pulse is able to produce over 4.5×10^{10} photons per shot with the photon energy over 5 keV.

Characterization of high spatial resolution and ultimate dynamic range of lithium fluoride X-ray detectors

S. Makarov¹

¹ Joint Institute for High Temperatures of the Russian Academy of Sciences, Moscow, Russia;
e-mail: seomakarov28@gmail.com

Various diagnostic techniques based on x-ray radiation such as coherent x-ray diffractive imaging (CXDI), ptychographic coherent diffractive imaging (PCDI), small-angle x-ray scattering (SAXS) are broadly used in our days for studying a matter at nanometer scale. The modern high-flux coherent x-ray synchrotrons as well as recently developed x-ray free electron lasers (XFELs) open opportunities for experimental investigations in field of high energy density physics (HEDP), in which both high spatial resolution and dynamic range of x-ray imaging techniques are crucial. Typically, the photodiodes, the image plates, radiochromic films, and charge-coupled devices (CCDs) are used in such experiments as the x-ray detecting systems. The disadvantages of such detectors are poor spatial resolution (>15 μm) and relatively low dynamic range ($< 10^5$).

A relatively new and promising x-ray detector is a lithium fluoride (LiF) in the form of bulk crystal and thin film which demonstrated its performance as 2D and 3D imaging tool in a wide range of applications including x-ray microradiographs of small biological objects in the water window spectral range, visualization and characterization of focused x-ray beams [1,2], coherent x-ray beam metrology by diffraction method [3], etc. Knowledge of the metrological properties of the LiF crystals such as sensitivity, dynamic range, the spatial resolution is an important prerequisite for its using as x-ray detector.

In frame this work, we demonstrate submicron spatial resolution and ultimate dynamic range of of LiF crystal as photoluminescence (PL) imaging detector. Also the response of LiF crystal detectors to monochromatic X-rays was measured in the multi-keV range. Finally, a photometric study is performed to assess the feasibility of using these detectors at current facilities, with the results showing that experiments carried out at moderate to larger laser facilities as well as XFELs could indeed benefit from the excellent combination of resolution, dynamic range and field-of-view that this diagnostic offers.

REFERENCES

- [1] T. Pikuz et al., *Sci. Rep.* 5 (2015) 17713
- [2] F. Bonfigli et al., *Optical Materials*, 58, 398-405 (2016)
- [3] M. Ruiz-Lopez et al., *J. Synchrotron Radiat.* 24 (2017)

Discharge wave propagation along an extended target irradiated by a short laser pulse

M. Ehret^{1,2}, K. Matveevskii³, Ph. Korneev^{3,4}, E. d'Humieres¹, G. Schaumann², V. Bagnoud⁵, M. Roth², V. T. Tikhonchuk¹ and J. J. Santos¹

¹ Université de Bordeaux, CNRS, CEA, CELIA, UMR 5107, Talence, France;

² Institut für Kernphysik, Technische Universität Darmstadt, Darmstadt, Germany;

³ National Research Nuclear University MEPhI, Moscow, Russian Federation;

⁴ P.N. Lebedev Physical Institute, Moscow, Russian Federation

⁵ Plasma Physik/PHELIX, GSI Helmholtzzentrum für Schwerionenforschung GmbH, Darmstadt, Germany

e-mail: matveevskiykonstantin@gmail.com

One of the promising and interesting approaches to generate strong magnetic and electromagnetic fields is to irradiate a continuous target of a complex shape with an intense short laser pulse. Such irradiation may result in a propagation of a strong discharge wave, being itself an interesting phenomenon and carrying strong transient field structure [1].

In the present work we analyze the experimental results of irradiating a wire target with a loop on the PHELIX facility (Darmstadt, Germany) [2]. The target is a long (length is 3 *mm*), thin (thickness is 50 μm) copper wire, attached to the irradiated plate. The target was irradiated with PHELIX laser pulse, having $\tau = 500$ *fs* duration and 50 *J* energy. With the use of proton deflectometry, the strong transient fields, having both electric and magnetic components, were detected along the wire. The measured phase velocity of the discharge wave front along the straight part of the Cu-target wire is varied from $(0.77 \pm 0.10)c$ to $(0.95 \pm 0.10)c$, having in average $(0.82 \pm 0.06)c$, where *c* is the light velocity [2].

To understand the propagation dynamics, an analytical model of discharge pulse propagation was developed. It assumes that the discharge wave is created by a strong ps-laser pulse and propagates along an extended target. We see that the boundary effects may significantly change the dynamics of the propagating wave. Results from this model were compared with PIC simulations, known analytical result for a metal conductor wire[3] and experimental data [2]. It is shown that without taking into account the absorption and the conductor structure it is difficult to describe consistently an experimental result. The reasonable explanation for the observed value of the discharge velocity comes from the assumption of the nonlinear collisionless absorption.

REFERENCES

[1] S. Kar et al., Nat. Comm. 7, 10792 (2016).

[2] M. Ehret, DOI: 10.13140/RG.2.1.3855.7847, (2016).

[3] V.V. Batygin, I.N. Toptygin, D. ter Haar, Problems in Electrodynamics, Second Edition. (1978)

Resonance absorption and electromagnetic static fields generation in an inhomogeneous relativistic plasma

I. I. Metelskii^{1,2}, V. F. Kovalev^{1,2,3}, V. Yu. Bychenkov^{1,2}

¹ All-Russia Research Institute of Automatics, ROSATOM, Moscow, Russia;

² P.N. Lebedev Physical Institute, RAS, Moscow, Russia;

³ Keldysh Institute of Applied Mathematics, RAS, Moscow, Russia

e-mail: metelski@lebedev.ru

A theory of the absorption and electromagnetic static fields generation in an inhomogeneous plasma based on the relativistic plasma resonance mechanism is constructed. The spatial and temporal characteristics of static fields are studied, the conditions for the relativistic effects manifestation and the angular dependence of the absorption coefficient are found. The influence of relativistic effects of the plasma electrons motion on the absorption coefficient is investigated. A comparison with the results of a linear and weakly non-linear theory is completed.

Ion mass effect on relativistic self-induced transparency in ultra-intense laser interaction with thin plasma slab

N. A. Mikheytshev^{1,2}, A. V. Korzhimanov^{1,2}

¹ Lobachevsky State University of Nizhny Novgorod, Nizhny Novgorod, Russian Federation;

² Federal Research Center Institute of Applied Physics of the Russian Academy of Sciences, Nizhny Novgorod, Russian Federation

e-mail: mikheytshev.nikita@gmail.com

Overdense plasmas irradiated by an ultra-intense laser pulse is known to become transparent due to relativistic effects if the laser intensity is high enough. This effect named relativistic self-induced transparency (RSIT) can play crucial role in many applications such as laser-plasma acceleration of ions, generation of high-energy density states of matter, production of bright gamma-flares and others. It has been shown that in those cases an efficiency of laser-plasma coupling and consequently an efficiency of the overall process is maximized at the threshold of RSIT. It makes the problem of theoretical prediction of this threshold to be of great importance.

In most cases, however, it can be safely considered that this threshold is the same as in the case of infinite plane traveling in homogeneous plasma that is $a_{th} = (n_0 - 1)^{1/2}$ where a_{th} is a dimensionless relativistic amplitude of the impinging radiation and n_0 is an electron concentration normalized to a critical one for a given laser frequency [1]. A notable exception is the case of circular polarized radiation interacting with a sharp edge of plasma slab. In this case due to a constant pressure of radiation electrons in the target form a high-density layer which effectively decreases RSIT threshold [2].

This threshold, however, can be decreased if electrons are heated to relativistic temperature [3]. Here we discuss how this decrease is affected by ion motion. Based on analytical model and numerical simulations we show that if ions are light enough than their motion neglect the heating effect and makes plasma slab more stable. This can have crucial effect in the interaction of circular polarized laser pulses of intensity exceeding 10^{21} W/cm² with thin near-critical density targets. In particular, we show numerically that for two plasma slabs of the same electron concentrations and thicknesses and different ion masses the slab consisted of lighter ions can be opaque whereas the slab consisted of heavier ions would be transparent for laser pulses of the same duration and intensity.

REFERENCES

[1] A. I. Akhiezer, R. V. Polovin, JETP 3, 696-705 (1956).

[2] F. Cattani et al., Phys. Rev. E 62, 1234-1237 (2000).

[3] E. Siminos et al., Phys. Rev. E 86, 056404 (2012).

On the motion of an electron in an intense laser pulse

V. P. Milant'ev¹

¹ Peoples' Friendship University of Russia, Moscow, Russia;
e-mail: vmilant@mail.ru

In the given report the motion of the relativistic electron in the laser femtosecond pulse, propagating along the constant magnetic field, is considered on the base of the Bogoljubov averaging method [1]. By this method one can obtain averaged equations of motion for the smoothed variables of the particle and oscillating corrections to them in the corresponding approximation in the expansions over the small parameter. Laser radiation is considered in the paraxial approximation which is based on the expansions over the small parameter [2, 3]:

$$\mu = a/z_R = 2/ka \ll 1$$

Here a is the pulse waist, $z_R = ka^2/2$ is the Rayleigh length, $k = 2\pi/\lambda = \omega/c$ is the wave number. Laser radiation is supposed to be relativistically strong, which means that parameter $g = eE/\omega m_e c \geq 1$. Some peculiarities of the averaging over the fast oscillations in this case are pointed out. Laser radiation is considered in the form the Gaussian beams of the arbitrary mode and polarization. The form of the pulse is also arbitrary. It is supposed that the pulse dimension is of order a . In such a case corrections of the first order to the transverse components of the vectors of the laser radiation play important role [3]. Periodical corrections to the smoothed dynamical variables are calculated and the law of the particle motion in the frame, moving with the averaged velocity, is found. It is shown that in the transverse plane the trajectory of the oscillating particle has, in general, elliptic character and its parameters are defined by polarization of radiation. In the direction of the pulse propagation the particle experienced oscillations with the wave frequency, twice frequency and the combined frequencies. It is shown that in the transverse plane an electron turns velocity, which depends on the intensity and polarization of radiation. It is also shown that in the direction of the pulse propagation the averaged force appears in the first approximation whereas in the case of rather small intensity of the wave its averaged action is effect of the second order. The obtained force is proportional to the intensity of radiation and caused by the pulse character of the laser radiation.

REFERENCES

- [1]. N.N. Bogoljubov, Yu.A. Mitropolskij, Asymptotic methods in the theory of nonlinear oscillations. Moscow. Nauka. 1974 (in Russian).
- [2]. T.W.B. Kibble, Phys. Rev. 150 1060 (1966).
- [3]. V.P. Milant'ev, S.P. Karnilovich, Ya.N. Shaar, Quantum Electronics 45 (11) 1063 (2015).

Ion acceleration at relativistic laser-plasma interaction of femtosecond pulses with nanoscale structured targets and with contrast control

I. M. Mordvintsev^{1,2}, S. A. Shulyapov¹ and A. B. Savel'ev^{1,2}

¹ Faculty of Physics and International Laser Center, M.V. Lomonosov Moscow State University, Moscow, Russia;

² P.N. Lebedev Physical Institute of the Russian Academy of Sciences, Moscow, Russia
e-mail: mordvincev_i@mail.ru

The experimental results on the relativistic laser-plasma interactions of femtosecond laser pulse with bulk targets and contrast control by controlled nanosecond prepulse and with nanoscale structured targets are presented. In our experiments we used a ultrafast pulse of Ti:Sa laser system (pulse duration - 50 fs, energy on target - up to 30 mJ, wavelength - 800 nm, repetition rate - 10 Hz, peak intensity - up to 5×10^{18} W/cm²). The controlled prepulse was created by Nd:YAG laser with active Q-switching, a wavelength of 532 nm. (second harmonic - 1064 nm.), pulse duration - 6 ns., pulse energy - up to 250 mJ at the main harmonic. Ions were registered with the use time-of-flight magnet spectrometer with the charge-to-mass (Z/M) separation and Thomson parabola mass spectrometer.

Development time-of-flight magnet spectrometer and Thomson parabola mass-spectrometer and experiments with contrast control by prepulse was supported by Russian Scientific Foundation grants No 18-32-00416 and 19-020-00104. Experiments with volume nanostructured was supported by Russian Science Foundation grant No 17-12-01283. Experiments with surface nanostructured targets was supported by Russian Science Foundation grant No 18-79-10160.

GEANT4 modelling of experiments on electron acceleration in dense laser plasma

A. Yu. Zavorotniy and A. B. Savel'ev

Faculty of Physics and International Laser Center, M.V. Lomonosov State University, Moscow, Russia

e-mail: akimzav@gmail.com

Recently the generation of powerful (up to petawatt) short (10 to 100 fs) laser pulses with intensities more than 10^{18} W/cm² became possible on a tabletop-scale systems. On interaction with matter, these pulses create plasma, inside which, due to a multitude of processes, acceleration of electrons occurs.

Relative simplicity of usage and maintenance, compactness and lower cost compared to conventional accelerators make the tasks of studying the mechanics of particle acceleration, optimization of such accelerators to be of practical value.

One of the difficulties in the task of optimization consists in the necessity of interpreting of experimental data. It is, however, impossible to obtain rigid analytical evaluation of the transmission function of the real systems, where multitudes of physical processes take place in nontrivial experimental geometry.

To resolve this problem, we use GEANT4 simulation toolkit, which utilizes Monte-Carlo methods with particle-level parallelism. The source code of the toolkit was modified to meet the demands of the experiments that are carried out in the Relativistic Laser Plasma Laboratory at the Faculty of Physics, MSU.

We will consider the following tasks:

- * predicting the quantity of emitted neutrons in the experiment of neutron generation in beryllium targeted by bremsstrahlung emitted from plasma,

- * determining the optimal angle of detection (and also evaluation of quantity) of positrons produced from the tungsten target irradiated by the electrons accelerated from plasma

- * calculation of adjustments to be applied to the electron spectrometer data processing algorithm necessary due to the modification of spectrometer

- * determining the transmission function of the real experimental setup for gamma quanta detection and investigating contribution of noise to the PMT signal.

This work was supported by RFBR under grant 19-02-00104.

Nonlinear processes in the injection and acceleration of electrons in plasma wake field in the interaction of a subterawatt laser pulse with a gas jet

V. Popov¹

¹ Joint Institute for High Temperatures of the Russian Academy of Sciences, Moscow, Russia;
e-mail: slavapopov1991@yandex.ru

The effect of nonlinear self-focusing and self-modulation processes on the acceleration of electrons of a subterawatt femtosecond laser pulse with a gas jet plasma was considered. A three-dimensional particle-in-cell (3D PIC) simulation of the interaction of laser radiation with a low-density nonuniform plasma shows that at the moment when the laser pulse reaches the region with plasma concentration, where the laser pulse power approaches the critical power of relativistic self-focusing, the laser pulse is compressed, which leads to an effective generation of the plasma wave. Due to a decrease in the phase velocity of the wake plasma wave generated via self-modulation of the laser pulse, electrons are trapped into the accelerating phase of the plasma wave and are accelerated to energies of ~ 10 MeV.

It is shown that under the conditions for limiting the interaction region of the plasma wave with the injected electrons by the length of their dephasing, quasi-monoenergetic electron bunches with a characteristic energy of ~ 9 MeV can be produced. The effective temperature of the accelerated electrons and their angular distribution, obtained by 3D PIC simulation, are in good agreement with those determined in the experiment.

Parametric instabilities and electron acceleration in relativistic laser-plasma interaction

V. V. Prokudin¹, I. N. Tsymbalov^{1,2}, D. A. Gorlova^{1,2} and A. B. Savel'ev^{1,3}

¹ Faculty of Physics and International Laser Center, M.V. Lomonosov Moscow State University, Moscow, Russia;

² Institute for Nuclear Research of the Russian Academy of Sciences, Moscow, Russia;

³P.N. Lebedev Physical Institute of the Russian Academy of Sciences, Moscow, Russia

e-mail: ladvalamon@mail.ru

Stimulated scattering plays a very important role in the propagation of laser-induced waves in plasma [1]. Consideration of these process in simulation is of a particular interest. One of them is stimulated Raman scattering (SRS), which can be considered as the resonant decay of an incident photon into a scattered photon and an electron plasma wave. When a powerful laser pulse propagates in a plasma, another type of decay associated with the transformation of the pump wave energy into electron plasma oscillations arises. This is the so-called two-plasmon decay instability (TPD), in which a laser wave breaks down into two electron plasma waves.

Various research groups currently conducting experiments on the production of electron beams as a result of laser-plasma interaction with the solid target. Based on these experiments, numerical simulations are usually performed using a PIC code. In this work we performed numerical experiment on the interaction of a relativistic lase pulse with a long dense preplasma layer with a 3D3V PIC code “Mandor“ in 2D3V regime. Simulations had shown that as a result of focusing, a longitudinal component of the electric field appears, which acts as the “seed“ for parametric processes. It can be seen that SRS appears first having a smaller threshold that stimulated Raman backscattering. Further, after an increase in intensity due to focusing and self-focusing, a different process begins to predominate: the laser pulse radiation scattered on plasma oscillations interferes with the incident one, which leads to a decrease in the amplitude of the transverse field component in areas with greater density and decrease in areas with lower density.

This work was supported by RFBR grants 19-020-00104 and 18-32-00868 mol-a.

REFERENCES

[1] W. L. Kruer, *The Physics of Laser Plasma Interactions* (Addison-Wesley Publishing Co., 1988)

Dynamics of electron beam emittance in laser-plasma accelerators

D. V. Pugacheva^{1,2}, N. E. Andreev^{1,2} and M. E. Veysman¹

¹ Joint Institute for High Temperatures of the Russian Academy of Sciences, Moscow, Russia;

² Moscow Institute of Physics and Technology (National Research University), Moscow, Russia;
e-mail: sedyakina.d@gmail.com

Method of charged particles acceleration based on interaction of short ultrarelativistic laser pulses with plasma is a promising technique and could be an alternative to conventional accelerators. However, for the practical application of laser-plasma accelerators and implementation of multi-stage acceleration schemes, accelerated particles beams must be of high quality [1]. One of the most important characteristics of a beam is emittance, and in our work we mainly focused on studying the dynamics of emittance during laser wake field acceleration (LFWA). In order to preserve the initial emittance of electrons that have gained ultrarelativistic energy during LWFA, we investigated the influence of nonlinearity and inconstancy of accelerating and focusing forces generated during the propagation of a laser pulse along a cylindrical plasma channel. We also showed the importance of the adiabatic change of the forces at the exit and entrance from the plasma channel for the successful acceleration of the electron beam in two stages.

REFERENCES

[1] P. A. Walker et al. *Journal of Physics: Conference Series*, 874 (1), 012029 (2017).

Structured laser pulse interaction with matter: QED effects and beyond

A. Pukhov¹

¹ University of Düsseldorf, Germany;
e-mail: pukhov@tp1.uni-duesseldorf.de

First, we investigate the interaction of electrons with different circularly polarized twisted light pulses in the framework of relativistic particle-in-cell simulations in a fully three-dimensional geometry. The interaction is very sensitive to both the twisted light mode and to the handedness of the laser. It is shown that the twisted light pulse can be used to excite spatially structured electron beams. Depending on the chosen laser parameters, it becomes possible to drive a train of azimuthally-symmetric electron bunches or to excite a discrete number of helical electron beams. The emerging electron patterns are characterized by full width at half maximum durations of the order of a few hundred attoseconds. In addition, it is reported on an efficient transfer of angular momentum from the twisted light field to the particles.

Second, electron bubbles driven in plasmas by LG are shown to have the advantage of conserving the electron polarization when the medium is pre-polarized. This might result in a compact injector of polarized electron bunches.

Third, we consider a few options to access the ultimate QED limit of matter in the strong electro-magnetic field, when $\xi\alpha^2/3 > 1$, where $\alpha = 1/137$ is the fine-structure constant and ξ is the nonlinear quantum parameter. This regime of fully non-perturbative QED has long been assumed to be not accessible experimentally. Yet, the progress in laser technology and particle accelerators may bring this regime within experimental reach.

Investigating the yield of X-rays emitted by a Si foil irradiated by a petawatt laser pulse.

S. N. Ryazantsev¹, I. Yu. Skobelev^{1,2} and S. A. Pikuz^{1,2}

¹ Joint Institute for High Temperatures of the Russian Academy of Sciences (JIHT RAS), Moscow, Russia;

² National Research Nuclear University MEPhI (Moscow Engineering Physics Institute), Moscow, Russia;

e-mail: sergryaz@mail.ru

Due to field ionization flows of high-energy (hundreds of MeVs) electrons are created in solid-state foils irradiated by the radiation of Petawatt Class Lasers. These electrons emit high-energy photons during refluxing (a process of multiple passing through the foil). The intensity of such X-ray source was estimated theoretically [1] on the base of plasma kinetics calculations carried out with ATOMIC code [2] as 10^{17} - 10^{18} W/cm² in a keV-range of photon energy. In order to check these predictions and validate an existing theoretical model the intensity of X-rays emitted by silicon foils of different thicknesses (5-20 μ m) which is exposed to high-intensity ($\sim 10^{21}$ W/cm²) picosecond laser pulse focused on a foil surface in a spot with radius of ~ 10 μ m was measured. It was found out that at least 0.5 J of incident laser energy (300 J) is converted to soft X-rays with photon energies from 1.6 to 2.7 keV and radiated in directions close to a target normal.

REFERENCES

[1] J. Colgan, J. Abdallah et al., PRL, 110, 125001 (2013).

[2] N. H. Magee, J. Abdallah et al., AIP Conf. Proc., 730, 168–179 (2004).

Determination of 100 TW femtosecond laser contrast from measurements of specular reflectivity from solid target

K. V. Safronov, V. A. Flegentov, S. A. Gorokhov, D. S. Gavrilov, S. F. Kovaleva, A. S. Tischenko, D. O. Zamuraev, A. L. Shamraev, E. S. Mokicheva and A. V. Potapov

¹ Experimental Physics Department, Russian Federal Nuclear Center - VNIITF, Snezhinsk, 456770, Russia;

Temporal contrast is a crucial parameter for high-power short-pulse laser facilities. At insufficient contrast, amplified spontaneous emission (ASE) prepulse - which is inherent to lasers based on chirped-pulse amplification scheme - can create plasma on surface of a solid target before arrival of the main pulse. This preplasma reduces coupling of the main laser pulse energy to dense target layers. Contrast influences laser-driven ion acceleration [1], $K\alpha$ radiation source properties [2], higher order harmonics generation [3]. Precise determination of contrast is a challenging task. It requires measurements with dynamic range higher than 10^{10} in time interval of ~ 10 ns with resolution of the order of the main pulse duration. A simple method for estimation of ASE prepulse energy was proposed in [4]. It is based on measuring brightness of specularly reflected from a solid target laser radiation on a scattering screen.

Using this method, we investigated ASE contrast of 100 TW femtosecond laser facility before and after insertion of RG-850 saturable absorber into amplification chain. ASE intensity was also measured over delay times from -400 ps to 0 ps by a 3rd order crosscorrelator. Analysis of the images from scattering screen has shown that, in addition to ASE prepulse, contrast is affected by change of laser light absorption mechanisms at intensities $10^{16} \div 10^{17}$ W/cm². This factor limits applicability of the method [4].

REFERENCES

- [1] D. Neely et al., Appl. Phys. Lett. 89, 21502 (2006)
- [2] S. Fourmaux, J.C. Kieffer, Appl. Phys. B 122:162 (2016)
- [3] I.J. Kim et al., Journal of Opt. Soc. Of Korea 13, 15 (2009)
- [4] A.S. Pirozhkov et al., Appl. Phys. Lett. 94, 241102 (2009).

Generation of ultra-hard broadband X-rays under interaction of subrelativistic femtosecond laser pulses with atomic and molecular clusters

T. A. Semenov^{1,2}, M. A. Djidjoev², K. A. Ivanov^{2,3}, I. A. Zhvania² and V. M. Gordienko²

¹ Federal Research Centre 'Crystallography and Photonics', RAS, Moscow, Russia;

² Faculty of Physics and ILC M.V. Lomonosov Moscow State University, Moscow, Russia;

³ P.N. Lebedev Physical Institute, RAS, Moscow, Russia;

e-mail: physics.letters@yandex.ru

The development of terawatt femtosecond lasers, which allow producing coherent radiation of sub and relativistic intensity, has opened the possibility for creating sources of X-ray radiation of ultrashort duration. The main field of application such sources is the diagnostics of fast processes, for example, using ultrafast absorption X-ray spectroscopy.

The experiments are aimed at studying the efficiency of a laser-cluster generator of ultrashort broadband bremsstrahlung (11-100 keV) X-ray pulses. The interaction of Ti:sapphire femtosecond laser radiation with atomic and molecular clusters occurred in the mode of subrelativistic intensity ($I \sim 300 \text{ PW/cm}^2$, 50fs duration). For measuring of the bremsstrahlung X-ray spectra laser plasma was used absolutely energy calibrated matrix detector of ionizing radiation Medipix. It is known that the total yield of X-ray photons strongly depends on the size of the clusters and the electrons density arising during clusters ionization. One way to control clusters' sizes and electron density is based on the use of a mixture consisting of a heavy molecular gas and a relatively light carrier gas, usually in higher concentration. Such clusters are generated during pulsed expansion of high pressure gas mixture into vacuum. We have investigated the efficiency conversion of laser light energy to broadband bremsstrahlung X-rays under interaction of focused sub-relativistic femtosecond laser pulses with atomic (Ar, Kr) and molecular clusters (CCl_2F_2) obtained in a mixture of CCl_2F_2 : He (1:10).

For the first time, a comparative analysis of the X-ray spectra of a cluster nanoplasma of Ar, Kr and CCl_2F_2 in the range of 11-100 keV. The obtained results made possible to estimate the conversion efficiency of laser pulse energy to high-energy X-ray in the range of 11-45 keV. Achieved conversion efficiency for argon and krypton clusters (gas pressure 25 bar) is 4×10^{-8} and 1.7×10^{-6} respectively. For the gas mixture $\text{CCl}_2\text{F}_2\text{He}$ (1:10 ratio at a pressure of 30 bar), the conversion efficiency turned out to be 1.4×10^{-7} . The maximum achieved X-ray quanta yield in full solid angle was 2×10^7 photons in the case of using krypton. The approximation of the obtained X-ray spectra by an exponential function made it possible to estimate the temperature of the plasma electrons. Plasma temperature varies in different spectral ranges: $T(11-17 \text{ keV}) = 1.27 \pm$

0.03 keV, $T_2(17-25 \text{ keV}) = 4.3 \pm 0.3 \text{ keV}$ for Ar, $T_1(11-20 \text{ keV}) = 2 \pm 0.1 \text{ keV}$, $T_2(20-33 \text{ keV}) = 5 \pm 0.15 \text{ keV}$, $T_3(33-45 \text{ keV}) = 12.5 \pm 0.1 \text{ keV}$ for Kr and $T_1(11-17 \text{ keV}) = 890 \pm 58 \text{ eV}$, $T_2(17-29 \text{ keV}) = 3.17 \pm 0.2 \text{ keV}$, $T_3(29-45 \text{ keV}) = 11.5 \pm 0.26 \text{ keV}$ for CCl_2F_2 . The generation of bremsstrahlung X-rays at relativistic laser intensity are also discussed in the report.

This work was supported by the Russian Foundation for Basic Research (Grant N 18-52-41007 and N 16-32-60171).

Electron acceleration in the interaction of relativistic laser radiation with sharp plasma interface

A. M. Senjkevich¹, I. N. Tsymbalov¹ and A. B. Savel'ev¹

¹ Lomonosov Moscow State University, Moscow, Russia
e-mail: alexandra1997.04.23@gmail.com

There is a method of obtaining high-energy electrons based on the interaction of intense laser radiation with the target material in the plasma state. Such sources of high-energy electrons can be used to solve various problems of nuclear physics. Today research is carried out to find the most effective regime of high-energy electrons generation.

One way to study the laser-plasma interaction is computer simulation. In our research, we use the PIC code MANDOR developed in LPI. In this work, we present the simulation results of interaction of laser pulse with an intensity of about $5 * 10^{18}$ W/cm², 50 fs in duration, with plasma gradient of length $L \sim 0.1\lambda$. These parameters are interesting for the following reasons.

In one of our experiments with similar laser pulse parameters, the following two pictures were observed: a well-collimated (0.05 rad) electron beam and a cone-shaped distribution of electrons (0.1 rad). From [1], it follows that the second situation takes place for the characteristic lengths of the plasma gradient $L \sim 0.1\lambda$. This allows us to suggest that in the above experiments we dealt with similar gradient lengths.

As already mentioned, we simulated the propagation of a laser pulse with intensity from $2.5 * 10^{18}$ W/cm² to 10^{19} W/cm² in plasma with a gradient length L from $\sim 0.05\lambda$ to $\sim 0.5\lambda$, for different incident angles. As results, we present the energy spectra of electrons for various simulation parameters mentioned above, describe the main observed mechanisms of their acceleration, and make assumptions regarding optimal parameters for generating high-energy electrons.

This work was supported by RFBR grants 19-020-00104 and 18-32-00868 mol_a.

REFERENCES

[1] Vacuum laser acceleration of relativistic electrons using plasma mirror injectors, M. Thevenet, A. Leblanc, S. Kahaly, H. Vincenti, A. Vernier, F. Quere & J. Faure, Nature Physics, 12, 355-360 (2016).

Pulsed Laser Plasma hard x-ray source for phase contrast imaging and applications in biology and material science

M. Gambari, A. Ferré, R. Clady, Y. Azamoum, L. Charmasson, O. Utéza and M. Sentis

Aix Marseille Université, CNRS, LP3 UMR 7341, 13288, Marseille, France;
e-mail: Sentis@LP3.univ-mrs.fr

The interest in developing brilliant, ultrashort, compact, and reliable hard x-ray sources at a reduced cost and laboratory size is motivated by a growing number of societal and scientific applications like non-destructive testing in industry, bio-medical imaging, or probing ultrafast lattice dynamics and phase transitions in material science [1, 2]. In addition of conventional accelerator-based x-ray sources of high brightness and femtosecond (fs) time resolution, laser-driven plasma x-ray sources using femtosecond TW class laser systems are a practical alternative with relative low cost, a reduced footprint and an intrinsic synchronization for pump and probe experiments. Among different laser plasma sources, K_α sources are developed for decades for applications such as x-ray absorption spectroscopy [3] and x-ray diffraction [4] or phase contrast imaging [1]. High benefits are indeed their simplicity and reliability.

An extended study of the absolute yield of a K_α x-ray source, produced by interaction of an ultrahigh intensity femtosecond laser with a solid Mo target (17.48 keV) for laser temporal contrast ratios in the range of $\sim 10^7 - 10^9$ and on three decades of intensity $10^{16} - 10^{19}$ W/cm², is presented. We demonstrate that for intensity $I \geq 2 \times 10^{18}$ W/cm² the K_α yield is independent of the value of the contrast ratio. Furthermore, at $I = 10^{19}$ W/cm² the K_α energy conversion efficiency reaches the same high plateau equal to $\sim 2 \times 10^{-4}$ (in 2π sr) for all the studied contrast ratios [3]. By increasing the repetition rate of the driving laser source up to 100 Hz [4], we measure the highest molybdenum K_α photon production reported to date corresponding to a K_α photon flux of 1×10^{11} ph/(sr.s).

In addition the evolution of the x-ray source size is deeply investigated as a function of the laser temporal contrast ratio, the intensity and the thickness of molybdenum target (from massive down to 10 μ m). For optimized irradiation conditions and target thickness, an estimated peak brightness of $\sim 10^{18}$ ph/(s.mm². mrad² (0.1 % BW)) at 100 Hz repetition rate is demonstrated making this X-ray source very attractive for applications.

Finally first results of a parametric study of phase contrast images on reference samples made of mylar sheets of calibrated thicknesses will be presented as well as biological sample images obtained by phase contrast technique in the free propagation regime for different laser driving intensity up to the relativistic regime.

REFERENCES

- [1] T. Elsaesser and M. Woerner, “Perspective: Structural dynamics in condensed matter mapped by femtosecond x-ray diffraction“, THE JOURNAL OF CHEMICAL PHYSICS, 140, 020901 (2014).
- [2] R. Toth, J.C. Kieffer, S. Fourmaux, T. Ozaki, and A. Krol, “In-line phase-contrast imaging with a laser-based hard x-ray source“, Review of Scientific Instruments 76, 083701 (2005).
- [3] Y. Azamoum, V. Tcheremiskine, R. Clady, A. Ferré, L. Charmasson, O. Utéza, and M. Sentis, “Impact of the pulse contrast ratio on molybdenum K_α generation by ultrahigh intensity femtosecond laser solid interaction“ Scientific Reports, 8, 4119 (2018).
- [4] R. Clady, Y. Azamoum, L. Charmasson, A. Ferré, O. Utéza, and M. Sentis, “22 W average power multiterawatt femtosecond laser chain enabling 10^{19} W/cm² at 100 Hz“ Applied Physics B, Lasers and Optics, 124, 89 (2018).

Electron acceleration in laser-irradiated solid targets with periodic surface structures

D. A. Serebryakov^{1,2}, T. M. Volkova², E. N. Nerush¹ and I. Yu. Kostyukov^{1,2}

¹Institute of Applied Physics of the Russian Academy of Sciences, Nizhny Novgorod, Russia

²Lobachevsky State University of Nizhny Novgorod, Nizhny Novgorod, Russia

e-mail: dms@appl.sci-nnov.ru

A process of electron acceleration near a solid-state target with rectangular grooves on the surface is considered. If the structure period is equal to the laser wavelength, a resonant acceleration may occur and electron bunches can be accelerated up to high energies by the laser electric field component in the direction of grooves [1]. Due to the presence of the microstructure, the relativistic electrons feel only the forward component of the field during the acceleration process, which allows for achieving energies up to hundreds of MeVs even for moderately relativistic field amplitudes $a_0 \sim 10$. A one-dimensional model allows for determining the condition for electron capture by the field structure and infinite acceleration. Also, three-dimensional PIC simulations demonstrate the feasibility of the considered acceleration process in more realistic situations.

REFERENCES

[1] A. Pukhov, I. Yu. Kostyukov et al., *Europ. Phys. J. Spec. Topics*, 223 (6), 1197 (2014).

Asymptotic theory of the ponderomotive dynamics of an electron in a relativistically intense focused electromagnetic envelope

O. B. Shiryayev^{1,2}

¹ Prokhorov General Physics Institute of the Russian Academy of Sciences, Moscow, Russia;

² Pirogov Russian National Medical Research University, Moscow, Russia

e-mail: DrOlegBShiryayev@gmail.com

A formalism for describing the relativistic ponderomotive dynamics of an electron driven by a focused relativistically intense optical envelope is derived via rigorous asymptotic resolution of the Newton and Maxwell equations in a small parameter proportional to the ratio of radiation wavelength to beam waist. The optical field description for expressing the Lorentz force relies on an envelope solution and the appropriate high-order corrections to the longitudinal and transverse components of the vector potential [1-3]. The ground-state and first order solutions for the electron motions are generated as functions of the electron proper time with the help of the Krylov-Bogolyubov method, the equations for the phase-averaged components of the ground state stemming formally from the requirement that the first-order solutions stay secular-free. For the scattering of a sparse electron ensemble by a relativistically intense laser pulse with an axially symmetric transverse distribution of amplitude, the resulting ponderomotive model further compactifies due to averaging over the random initial directions of the electron momenta. Distributions of the electron scatter relative to the optical field propagation axis and energy spectra within selected angles follow from the resulting ponderomotive model. The electron scatter obeys an energy-angle dependence stemming from the adiabatic invariance inherent in the model, with smaller energies corresponding to greater post-interaction angular deviations of electrons from the field propagation axis [4].

The author acknowledges the partial support for this study contributed by the Extreme Optical Fields and their Interactions with Matter Program N 6 of the Presidium of the Russian Academy of Science (Project 4.6).

REFERENCES

- [1] B. Quesnel, P. Mora, Phys. Rev. E 58, 3719 (1998)
- [2] V.P. Milant'ev, S.P. Karnilovich, Ya.N. Shaar, Quantum Electronics, 45(11), 1063, (2015)
- [3] O.B. Shiryayev, Laser and Particle Beams 35, 64 (2017)
- [4] O.B. Shiryayev, arXiv:1901.02335v3 [physics.plasm-ph]

The effect of laser pulse contrast and duration on the γ -ray yield in laser-plasma interactions

S. A. Shulyapov¹, I. N. Tsymbalov¹, K. A. Ivanov^{1,2}, R. V. Volkov¹,
A. B. Savel'ev^{1,2}, A. V. Brantov² and V. Yu. Bychenkov²

¹ Faculty of Physics and International Laser Center, M.V. Lomonosov Moscow State University, Moscow, Russia;

² P.N. Lebedev Physical Institute of the Russian Academy of Sciences, Moscow, Russia
e-mail: Ser270489@yandex.ru

Femtosecond laser plasma is a brilliant source of ultra-short bursts of high energy electrons, which lead to the generation of hard X- and γ -rays. The electron acceleration mechanisms are significantly dependent on the laser pulse parameters, such as: intensity, duration and contrast. So, the energy and flux of γ -rays generated in a plasma can be significantly increased by using a subrelativistic intensity ($7 \cdot 10^{18} \text{W/cm}^2$) pulse with a low (10^{-5}) ASE contrast compared with a case of high ASE contrast (10^{-8}) [1]. Moreover, there was an increase of γ -radiation yield with the increasing of laser pulse duration (from 45 to 350fs) at a constant energy (intensity decreases) [1]. For studying the mechanisms of electron acceleration we used a nanosecond duration (10ns) pulse to simulate an ASE pedestal for a short (50fs) high-contrast (10^{-7}) main pulse of relativistic intensity ($2 \cdot 10^{18} \text{W/cm}^2$) [2]. In this work we present experimental and numerical simulations results on γ -emission from plasma in the case of different main pulse durations (up 1700fs) and nanosecond artificial prepulse as ASE pedestal. It was shown that when the prepulse is ahead of the main pulse by ~ 20 ns, the γ -ray yield can be increased more than 10 times by increasing the main pulse duration from 50 to 1700fs. Parametrical processes developing in the plasma lead to electron acceleration. However, the required plasma gradient is formed due to electron impact ionization in the field of the main pulse.

In our experiments we used Ti:Sa laser system (p-pol, pulse duration - 50-1700fs, energy on target - 25mJ, wavelength - 800nm, repetition rate - 10Hz, ASE level - 10^{-7}). Pulse duration was changed by the grating compressor detuning. For creation controlled pre-plasma layer we used Nd:YAG laser (8ns, 130mJ, 1064nm) locked with Ti:Sa laser system. Numerical simulations were done using fully relativistic PIC code Mandor.

This work was supported by RFBR grant N 19-02-00104.

REFERENCES

- [1] K.A. Ivanov, S.A. Shulyapov, P.A. Ksenofontov et al., Physics of Plasmas 21 (9), 093110 (2014).
- [2] K.A. Ivanov, I.N. Tsymbalov, S.A. Shulyapov et al., Physics of Plasmas 24 (6), 063109 (2017).

Towards the analysis of attosecond dynamics in complex systems

E. Suraud^{1,2} and P. M. Dinh¹ and P. G. Reinhard³

¹Laboratoire de Physique Théorique, France

²School of Mathematics and Physics, Queen's University Belfast, United Kingdom

³Institut für Theoretische Physik, Universität Erlangen Germany

e-mail: suraud@irsamc.ups-tlse.fr

The progress in laser technology over the last decades has opened up new avenues for the exploration of properties of clusters and molecules. A laser pulse is characterized by its frequency but also by the laser intensity as well as the laser time profile. While for years the variations of these parameters were heavily constrained by technology, the last two decades and even more so the last years have seen tremendous increases in the range of attainable parameters. This is true for intensity, which since the 1990's can reach huge values which can lead to very large energy deposits and possibly violent disintegration of the irradiated species. But this is also true for the tuning of the time profile which can now be tailored up to time scales of the order of magnitude of electronic motion and even below. This allows the follow up of the detail of electronic dynamics at its own "natural" time. The latest breakthroughs were attained in terms of laser frequency with the ongoing possibility of reaching very large frequencies up the X domain. This opens up new possibilities of imaging which are progressively being explored.

We shall focus in this presentation on the recent explorations of electron dynamics down to the attosecond time scale. We shall first present some experimental cases, whose characteristics can be well reproduced by time dependent microscopic theories. We shall then seek for a detailed explanation of observed trends and introduce a schematic model which surprisingly enough provides a remarkable account of experimental trends. It shows in particular that the response of the system is heavily biased by properties of the laser used for exciting and testing the system, especially its IR component. Using the ideas developed in the schematic model we shall reanalyze former computed data and show how much one can attain system's properties.

REFERENCES

- [1] U. Saalmann, C. Siedschlag, J. M. Rost, *J. Phys. B* **39** (2006) R39.
- [2] F. Calvayrac, P. G. Reinhard, E. Suraud, C. Ullrich, *Phys. Reports* **337** (2000) 493-578.
- [3] Th. Fennel, K.-H. Meiwes-Broer, J. Tiggesbäumker, P.-G. Reinhard, P. M. Dinh, E. Suraud, *Rev. Mod. Phys.* **82** (2010) 1793.
- [4] C. Neidel et al *Phys. Rev. Lett* **111** (2013) 033001.
- [5] C.-Z. Gao, P. M. Dinh, P.-G. Reinhard, E. Suraud, *Phys. Chem. Chem. Phys.* **19** (2017) 19784

PW laser driven particle acceleration: novel regime of acceleration

S. Ter-Avetisyan¹

¹ ELI-ALPS, Szeged, Hungary
e-mail: sargis.ter-avetisyan@eli-alps.hu

The development of ultrahigh-power laser systems in the last two decades has led to increasing attention and enormous scientific activities in the field of laser-plasma interactions. A laser peak power can reach several petawatts (PW) and producing a large spatiotemporal energy concentration of a laser beam the intensity above 10^{22} W/cm² can become available for experiments. Thus, it opens up an entirely new area of research; the regime of relativistic plasma physics became accessible in the lab. To explore the interaction physics in these novel intensity regime is one of the most exciting goals of current high field research.

We will discuss the laser plasma ion acceleration phenomena in particular by careful study of complex dynamics of laser-plasma processes through characteristics of the ion source and beam properties. The excellent “point-source“ characteristics of laser accelerated proton beam in a broad energy range was found by using proton radiographs of a mesh. The “virtual source“ of protons, the point where the proton traces are converging and form a waist, gradually decreases and moves asymptotically to the target with increasing particles' energy. Computer simulation additionally verified the “virtual source“ transformation into a real source on the target with a size about laser spot size when particles energy is further increased.

The laser ponderomotive force pushes the electrons deep into the target creating a bipolar charge structure, i.e., an electron cavity and spike which produces strong accelerating field, realising a point-size source of accelerated protons. This behaviour has had not previously been predicted. These results contribute to the development of next generation laser-accelerators suitable for many applications.

This presentation is closely related to recent development or imminently anticipated development of laser technology to bring the existing laser power to a multi-PW level to study relativistic plasma phenomena and, ion acceleration in this new regime. The new findings pave a way to achieving an ion source and beam desire parameters for applications (e.g. cancer radiotherapy) and they encourage further activities for optimisation of laser plasma-based accelerators.

Direct electron acceleration with injection through the breaking of plasma waves of parametric instabilities

I. N. Tsymbalov^{1,2}, D. A. Gorlova^{1,2}, S. A. Shulyapov¹, V. V. Prokudin¹,
 A. Yu. Zavorotny¹, K. A. Ivanov^{1,3}, R. V. Volkov¹, V. Yu. Bychenkov³,
 V. G. Nedorezov² and A. B. Savel'ev^{1,3}

¹ Physics Faculty and International Laser Center of M.V. Lomonosov Moscow State University, Moscow, Russia;

² Institute for Nuclear Research of Russian Academy of Sciences, Moscow, Russia;

³ P.N. Lebedev Physical Institute of Russian Academy of Sciences, Moscow, Russia
 e-mail: ivankrupenin2@gmail.com

Efficient direct electron acceleration in the plasma channel with injection through the breaking of plasma waves generated by parametric instabilities was demonstrated experimentally and reproduced in the 2D3V PIC simulations [1]. The electron bunch was produced using the specific plasma profile containing arbitrary sharp, $\sim 0.5\lambda$, gradient at the vicinity of 0.1-0.5 critical density and a long tail of a tenuous preplasma. Such a preplasma profile was formed by an additional nanosecond laser pulse with intensity of 5×10^{12} W/cm². In the case of optimal preplasma parameters femtosecond laser pulse with an intensity of 5×10^{18} W/cm² and an energy of 50 mJ generates a collimated electron bunch having divergence of 50 mrad, exponential spectrum with the slope of ~ 2 MeV and charge of tens of pC. The charge was confirmed measuring neutron yield from Be(g,n) photonuclear reaction with threshold of 1.7 MeV. By the contrast, a ring-like electron beam with divergency of 300 mrad and significantly lower charge is generated if the prepulse intensity drops to 5×10^{11} W/cm². The 2D PIC simulations confirmed beamed electron's acceleration in the plasma channel (so-called direct laser acceleration, or DLA). This channel is formed in a long tail of tenuous preplasma by the laser pulse specularly reflected from the arbitrary sharp gradient. The ring-like electron beam was attributed to the longer gradient case enlarging divergence of the reflected laser beam, preventing channel's formation and electron acceleration by the so-called vacuum laser acceleration, or VLA. We also showed that injected electrons appeared from the wave breaking of plasma waves of hybrid SRS-TPD instability for the both gradients. Electrons received an initial momentum from this breaking to be effectively injected into the plasma channel.

This work was supported by RFBR grants 19-020-00104 and 18-32-00868 mol-a. D. A. Gorlova acknowledges Foundation for the advancement of theoretical physics "BASIS" for the financial support.

REFERENCES

[1] I.N. Tsymbalov et.al., accepted to PPaCF (2019).

Diagnostics of different laser parameters via direct proton acceleration

O. E. Vais^{1,2}, A. G. R. Thomas³, A. M. Maksimchuk³, V. Yu. Bychenkov^{1,2}

¹Lebedev Physical Institute of the Russian Academy of Sciences, Moscow, Russia;

²Center For Fundamental and Applied Research, Dukhov Research Institute of Automatics (VNIIA), Moscow, Russia;

³Center for Ultrafast Optical Science, University of Michigan, Ann Arbor, Michigan 48109-2099, USA

e-mail: ovais@lebedev.ru

Contemporary laser technologies are aimed at exceeding extraordinary levels of the laser power and development laser facilities of the PW-power. Such systems require high quality of their own components and up-to-date technologies of the laser pulse monitoring. The latter issue is of prime importance because its solution should have high precision as well as low expenses. Being tightly focused the powerful laser pulses achieve extremely intensities in their focal spot and overstep applicability ranges of traditional diagnostic techniques. Therefore new methods of laser diagnostics are of high demand. One of possible approaches uses distributions of particles directly accelerated from rarefied gases (or nano-thickness foil) by the studied laser pulse [1, 2].

This report is devoted to the variant of the mentioned technique, which is based on the interaction of the laser pulse with protons. We use the test particle method to describe proton dynamics, that consists of the solution of nonrelativistic equation of motion with ponderomotive force. The results have been previously compared with the results of more accurate model (relativistic equation with Lorentz force). The focused laser pulse is simulated by Stratton-Chu integrals [3], that allows describing different initial laser spatial-temporal profiles and focusing in the focal spot down to the diffraction limit. We have studied impact of the laser parameters, such as peak power, focal diameter, spatial anisotropy and pulse duration, on angular-spectral distributions to analyze the opportunity of the laser pulse diagnostics via these characteristics.

The work was supported by the Russian Science Foundation (grant no. 17-12-01283) and Fellowship of Foundation for the Advancement of Theoretical Physics “BASIS” (grant No. 18-1-5-102-1) for O.E. Vais.

REFERENCES

- [1] A. L. Galkin, M. P. Kalashnikov, et al., *Phys.Plasmas*, 17, 053105 (2010).
- [2] O. E. Vais, V. Yu. Bychenkov, *Appl. Phys. B*, 124, 211 (2018).
- [3] J.A. Stratton, L. J. Chu, *Phys.Rev.*, 56, 99 (1939).

Nonlinear Thomson scattering of an ultratightly focused laser pulse on ensembles of electrons

O. E. Vais^{1,2} and V. Yu. Bychenkov^{1,2}

¹Lebedev Physical Institute of the Russian Academy of Sciences, Moscow, Russia;

²Center For Fundamental and Applied Research, Dukhov Research Institute of Automatics (VNIIA), Moscow, Russia

e-mail: ovais@lebedev.ru

Rapid growth of the laser powers enables to achieve high-energy concentration in space and time. Such conditions allow studying unique regimes of laser interaction with matter, that is followed by processes of ionizations, particle accelerations and emissions of different kinds of secondary radiation. The present report is devoted to one of the latter effects, namely, nonlinear Thomson scattering. This process has been much studied in the case of the laser interaction with a single particle, when the laser field was represented by the tightly focused laser beam as well as the plane electromagnetic field [1, 2]. We, in turn, have considered the scattering of a tightly focused laser pulse on ensembles of electrons.

Laser-particle interactions are described by the test particle method, that consists of the solution of the relativistic equation of electron motion with Lorentz force. All six components of the laser field are calculated by Stratton-Chu integrals, which allow modeling laser pulses with different spatial-temporal profiles focused into the focal spot with the smallest diameter (down to the diffraction limit). We have studied nonlinear Thomson scattering of laser pulses with different peak intensities and focal spot sizes and analyzed dependences of its angular-spectral distributions on considered laser parameters.

Conditions discussed here are attainable in real experiments, that emphasizes actuality of the studying. This process could claims to be a new method of diagnostics of laser intensities, that is of high interest for high-power laser sciences.

The work was supported by the RFBR grants Nos. 18-02-00452, 18-32-00406 mol_a and Fellowship of Foundation for the Advancement of Theoretical Physics “BASIS” (grant No. 18-1-5-102-1) for O.E. Vais.

REFERENCES

- [1] O. E. Vais, S. G. Bochkarev, V. Yu. Bychenkov, Plasma Phys.Reports, 42, 818 (2016).
- [2] Y. Y. Lau, F. He, D. P. Umstadter, R. and Kowalczyk, Phys. Plasmas., 10, 2155 (2003).

On electron acceleration in guiding structures with account for parametric resonances and synchrotron radiation

M. Veysman¹, N. E. Andreev^{1,2}

¹ JIHT RAS, Moscow, Russia

² MIPT, Moscow, Russia

e-mail: bme@ihed.ras.ru

Not only commonly used plasma channels, but also gas filled capillary waveguides can be effectively used for propagation over many Rayleigh length of laser pulses, creating wakefields behind them. These wakefields can be used for acceleration of electron bunches, provided parametric excitation of betatron oscillations are excluded throughout the acceleration stage.

From other hand, parametric excitation of betatron oscillations in capillary waveguides or in plasma channels with specially fitted ratio of characteristic width of a channel to laser spot size can be used for effective generation of synchrotron radiation in ultraviolet or X-ray range. Besides that, synchrotron radiation can be used for diagnostic of betatron oscillations.

As well as betatron oscillations of electrons in guiding structures directly determines emittance of electron bunches [1, 2, 3], monitoring of synchrotron radiation can be used for control of quality of wakefields suitable for creation of low-emittance accelerated electron bunches. To preserve low emittance of accelerated electron bunch, one should avoid parametric excitation of betatron radiation throughout acceleration stage.

REFERENCES

- [1] M. Reiser, (Wiley-VCH Verlag GmbH, 2007), .
- [2] T. Mehrling, J. Grebenyuk, F. S. Tsung, K. Floettmann, and J. Osterhoff, Phys. Rev. ST Accel. Beams 15, 111303 (2012).
- [3] M. E. Veysman and N. E. Andreev, Quantum Electronics , to be submitted (2019).

Generation of sub-Mev electrons in krypton cluster nanoplasma by relativistic femtosecond laser pulses

I. A. Zhvaniya¹, K. A. Ivanov^{1,2}, M. S. Dzhidzhoev¹, T. A. Semenov^{1,3},
R. V. Volkov¹, A. B. Savel'ev¹ and V. M. Gordienko¹

¹ Physical faculty and ILC Moscow State University, Moscow, Russia;

² P.N.Lebedev Physical Institute of the Russian Academy of Sciences, Moscow, Russia;

³ Institute of crystallography RAS, Moscow, Russia

e-mail: zhvania@mail.ru

The cluster jet target utilized in high intensity ultrashort laser-driven plasma experiments is a prospect low-debris source of hard X-ray, relativistic electrons, terahertz waves etc. Proper knowledge of plasma properties is a key to deep understanding of fundamental process occurring during the interaction. This makes it possible to optimize plasma (in other words, cluster parameters) for best conditions providing generation of high energy electrons. The higher Z-number atoms are used to compose clusters - the greater amount of electrons could be generated in such plasma.

In this work we made a study of plasma and high-energy electrons emitted by it under interaction of relativistic femtosecond laser pulse with ultrasonic jet of krypton nanoclusters. The comparative experiments were carried out with the commonly used argon clusters. The radiation was delivered by Ti:Sa laser system (805nm, 10Hz, >30mJ, 50fs, $I_{peak} > 10^{18}$ W/cm²) and focused inside a vacuum chamber by an off-axis parabolic mirror. The clusters are generated under ultrasonic expansion of gas through the nozzle into vacuum.

The technique of complex diagnostics of nanoplasma is developed. Using hard X-ray detectors (PMT with NaI scintillator and Amptek XCR-100 spectrometer) and an electron imaging and energy resolving matrix detector MediPix we studied the hard X-ray spectra of plasma and the fast particles angular distribution in dependence of laser pulse energy and duration. A broadband X-ray photons generation at a background of characteristic linear radiation (K-alpha and beta bands) was observed. It made possible to estimate nanoplasma temperature that is important to clarify interconnection between plasma parameters and high energy electron generation. It has been also demonstrated that contrast ratio of linear component may be controlled by varying the peak intensity of the laser radiation.

We have for the first time observed electrons with the energies more than 400keV generated under laser excitation of krypton clusters. In this work we discuss plasma parameters required for high energy electron generation in the cluster jet at different laser intensities from 10^{17} W/cm² up to relativistic values.

This work was supported by RFBR grant N 16-32-60171

Section 2: Ultrafast phenomena in condensed matter and ionized gases

Section Chair:

Sergey Uryupin, e-mail: uryupin@lebedev.ru
(Lebedev Physical Institute, Russia)

Program committee:

Nadezhda Bulgakova
(HiLASE Centre, Czech Republic)

Sergey Popruzhenko
(Max Planck Institute for the Physics of Complex Systems, Germany)

Stanislav Bezhanov
(Lebedev Physical Institute, Russia)

Scope

Optical properties of heated solid conductors

Instabilities and high-frequency phenomena in photoionized plasma

Non-linear phenomena in nonequilibrium plasma and metals

Kinetics of rapidly heated electrons in metals and plasma

Development and applications of ultrafast electron diffraction

S. A. Aseyev¹, S. V. Chekalin¹, A. A. Ischenko², V. O. Kompanets¹,
B. N. Mironov¹, E. A. Ryabov¹

¹ Institute of Spectroscopy, Russian Academy of Sciences, Troitsk, Moscow, 108840 Russia;

² Russian University of Technology-MIREA, prosp. Vernadskogo 78, 119454 Moscow, Russia
e-mail: isanfemto@ya.ru

Here are demonstrated direct methods to map femtosecond laser-perturbed matter in the spatially-temporal continuum, based on the probing of laser-excited sample by ultrashort electron pulses, strictly synchronized with fs laser. We describe a number of experiments in the field of ultrafast electron microscopy and diffraction done at the Institute of Spectroscopy RAS.

Effects of metal heating on the spectral composition and generation efficiency of terahertz radiation

S. G. Bezhanov^{1,2} and S. A. Uryupin^{1,2}

¹ P.N.Lebedev Physical Institute of the RAS, Moscow, Russia;

² National Research Nuclear University MEPhI, Moscow, Russia

e-mail: bezhanovsg@lebedev.ru

Using relatively simple model of electrons' and lattice heating and thermal transfer, we have calculated the changes in THz radiation generated in gold heated by a femtosecond laser pulse[1]. Significant increase of the temperatures of electrons and the lattice over the duration of the pulse is accompanied by a strong amplification in the efficiency of THz generation from the drag force and the electron pressure gradient. Rapid change of the electron temperature causes relative increase in the emission spectrum at the frequencies greater than the inverse duration of the pulse, as well as some peculiarities related to the typical electron-lattice energy transfer time.

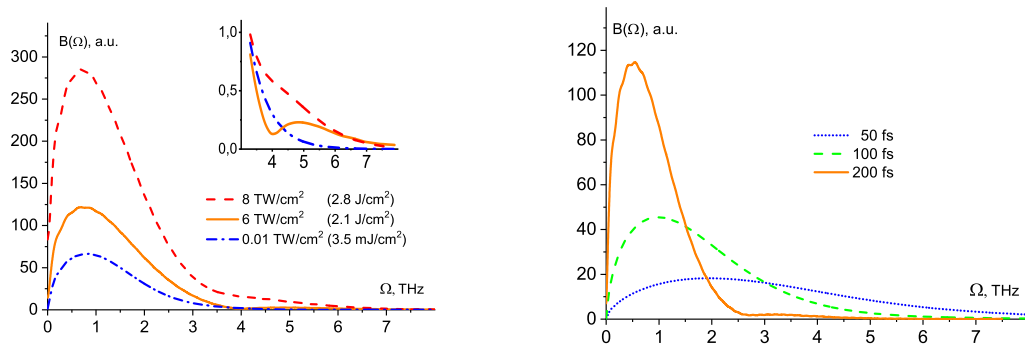

Figure 1: Spectral density in the THz pulse for different incident pulse energy densities (left) and incident pulse durations (right).

REFERENCES

- [1] S.G.Bezhanov, S.A.Uryupin, Laser Physics Letters, v.16, 076002 (2019).

Critical assessment of ultrafast laser-induced processes in transparent dielectrics: New results and challenges

N. M. Bulgakova^{1,2}, V. P. Zhukov^{1,3}, I. Mirza¹, J. Sladek¹, T. J.-Y. Derrien¹,
S. Akturk⁴

¹ HiLASE Centre, Institute of Physics ASCR, Dolní Břežany, Czech Republic;

² S. S. Kutateladze Institute of Thermophysics SB RAS, Novosibirsk, Russia;

³ Institute of Computational Technologies SB RAS, Novosibirsk, Russia;

³ Karaiskaki 13, Chalandri 15233, Athens, Greece

e-mail: bulgakova@fzu.cz

Interaction of ultrashort laser pulses with transparent materials (crystals and glasses) is of high interest for many applications ranging from damage of optical elements to inscription photonic structures inside material bulk. On the other hand, it is a long-standing problem of fundamental understanding of ultrafast processes in wide bandgap materials. In this talk, we will critically analyze different models which exist for description of laser light propagation in transparent materials and elementary processes responsible for excitation and relaxation of free electrons and the defect states. Several examples of simulations for the cases of ultrashort pulse action on material surface [1] and bulk modification [2] will be presented. Advantages of spatiotemporal shaping will be discussed [3,4] in comparison with the experimental results.

REFERENCES

[1] I. Mirza, N. M. Bulgakova, J. Tomáščík, V. Michálek, O. Haderka, L. Fekete, T. Mocek, *Sci. Reports* 6, 39133 (2016).

[2] N. M. Bulgakova, V.P. Zhukov, S.V. Sonina, Y.P. Meshcheryakov, *J. Appl. Phys.* 118, 233108 (2015).

[3] V. P. Zhukov, A. M. Rubenchik, M. P. Fedoruk, N. M. Bulgakova, *J. Opt. Soc. Am. B* 34, 463-471 (2017).

[4] V. P. Zhukov, S. Akturk, N. M. Bulgakova, *J. Opt. Soc. Am. B* (2019), in press.

Terahertz radiation at the interaction of two counterpropagating laser pulses in rarefied plasma

A. A. Frolov

P.N. Lebedev Physical Institute RAS, Moscow, Russia;
e-mail: frolovaa@lebedev.ru

The considerable interest in many research groups to the generation and detection of terahertz (THz) radiation is associated with the possibilities of its application in science, technology and practical applications. The effective scheme for generating THz waves is proposed, when two counterpropagating laser pulses interact in a rarefied plasma. The theory of radiation developed at the doubled plasma frequency during the interaction of pulses with identical frequencies [1] is generalized here to the case of laser pulses with differing frequencies. As in the publication [1], the generation of THz electromagnetic radiation in the scheme under consideration is due to the excitation of small-scale wake plasma fields and their interaction in the region of overlap of laser pulses. That is, an electromagnetic wave appears as a result of the fusion of two plasma waves, or in other words, the generation of THz radiation is associated with an elementary nonlinear process of fusion of two plasmons with the generation of a photon.

Spectral, angular and energy characteristics of THz waves are investigated. The spectrum of THz radiation is analyzed and it is established that it essentially depends on the frequency difference between laser pulses. It is shown that even with a small difference in the pulse frequencies a maximum in the emission spectrum appears near the plasma frequency together with the line at the doubled plasma frequency. The height of this maximum increases with increasing frequency difference and reaches its maximum when the frequency difference coincides with the plasma frequency. The total energy of the THz pulse is calculated and it is shown that the radiation energy at the plasma frequency has maximum when the difference in the frequency of the pulses coincides with the plasma frequency.

The work was supported by the RFBR (project No. 17-02-14 00648-a)

REFERENCES

- [1] L.M. Gorbunov, A.A. Frolov. JETP 125 (3) 598, (2004).

Optical generation and control of surface acoustic waves

R. Bauer¹, D. Schmidt¹, J. Schwarzkopf² and P. Gaal^{1,2}

¹ Institut für Nanostruktur- und Festkörperphysik, Universität Hamburg Department Physics, Hamburg, Germany;

²Leibniz-Institut für Kristallzüchtung, Berlin, Germany;
e-mail: pgaal@physnet.uni-hamburg.de

Since recently, dynamic strain is employed as excitation in solids and nanostructures to study the interaction of optical [1], electronic[2] or magnetic[3] properties with the crystal lattice. In fact, strain can be employed as functional tool to drive specific processes, if the dynamics can be controlled reliably on short time and length scales. Here, we present a summary of our recent activities of photoacoustic strain generation with a special focus on controlled nanoscale deformations at surfaces. The aim is to fully control the deformation amplitude within few picoseconds. We use a temporal series of interfering laser pulses to excite transient thermal and acoustic gratings in solid heterostructures. Our method not only allows for controlling the oscillation of coherent excitations but also the amplitude of the incoherent thermal background. To monitor transient changes of the surface, we employ synchrotron-based time-resolved x-ray reflectivity (TR-XRR), which allows for measurement of the transient deformation with sub-Åprecision [4]. Several examples of spatiotemporal coherent control of surface deformations [5] will be discussed, together with first applications of strain excitation in magnetic materials and in active x-ray optic devices.

REFERENCES

- [1] D. J. Singh, Q. Xu, and K. P. Ong, Applied Physics Letters 104, 011910 (2014).
- [2] M. Wei, J. B. Kinzel, F. J. R. Schlein, M. Heigl, D. Rudolph, S. Morktter, M. Dblinger, M. Bichler, G. Abstreiter, J. J. Finley, G. Koblmüller, A. Wixforth and H. J. Krenner, Nano Letters 14, 2256 (2014).
- [3] A. V. Scherbakov, A. S. Salasyuk, A. V. Akimov, X. Liu, M. Bombeck, C. Brüggemann, D. R. Yakovlev, V. F. Sapega, J. K. Furdyna, and M. Bayer, Phys. Rev. Lett. 105, 117204 (2010).
- [4] M. Sander, J.-E. Pudell, M. Herzog, M. Bargheer, R. Bauer, V. Besse, V. Temnov, and P. Gaal, Applied Physics Letters 111, 261903 (2017)
- [5] M. Sander, M. Herzog, J. E. Pudell, M. Bargheer, N. Weinkauff, M. Pedersen, G. Newby, J. Sellmann, J. Schwarzkopf, V. Besse, V. V. Temnov, and P. Gaal, Physical Review Letters 119, 075901 (2017)

Ab-initio description of the influence of incoherent electron-phonon scattering on laser-induced structural relaxation processes

B. Bauerhenne, S. Krylow and M. E. Garcia

Institute of Physics and Center of Interdisciplinary Nanostructure Science and Technology (CINSA-T), University of Kassel, Heinrich-Plett-Str 40, 34132 Kassel, Germany
e-mail: garcia@physik.uni-kassel.de

We developed a description of the laser induced structural relaxation of solids including thermal and nonthermal effects on the same footing. Our theory uses ab-initio and ab-initio-based molecular dynamics simulations. The electron-phonon coupling is explicitly taken into account by means of the Allen formalism, based on the Eliashberg function. Our theoretical method allows us to determine to which extent nonthermal effects caused by changes of the potential energy surface upon laser excitation influences the further relaxation of the system.

In this presentation we address the laser induced ultrafast structural dynamics of three different materials: graphene, silicon and antimony.

With the help of our code CHIVES (Code for Highly excited Valence Electron Systems), extended to account for incoherent electron-phonon scattering, we studied the structural relaxation of graphene upon laser excitation. We obtain two time-scales for the structural response, which manifest themselves by a two-step decay in the intensity of Bragg peaks. The fastest relaxation time is due to the interaction between the excited electrons and the strongly coupled optical phonons (SCOPs) at a few points of the Brillouin zone. The slower relaxation time is governed by phonon-phonon interactions. The phonon gas in graphene remains a long time outside thermodynamical equilibrium.

In order to extend the ab-initio description to larger length scales we developed a method to obtain analytical interatomic potentials for laser-excited silicon and antimony, which depend on the electronic temperature. The potentials are expanded into polynomials and the coefficients are fitted to simulations performed with CHIVES under different conditions. With the help of these potentials we were able to perform large-scale simulations and to definitively answer the question if electron-phonon coupling prevents observation of non-thermal effects or not.

THz radiation generation via interaction of ultrashort laser pulse on a metal-dielectric system

V. E. Grishkov and S. A. Uryupin

P. N. Lebedev Physical Institute of the Russian Academy of Sciences, Moscow, Russia
e-mail: grishkovslava@mail.ru

The analysis of the low-frequency radiation generated by solid metal-dielectric structure irradiated by a femtosecond laser pulse is presented. The spectral composition, total energy and radiation pattern of the THz radiation as a functions of laser radiation characteristics were studied.

Cycle-averaged low-collision-rate excitation of electrons of wide-band-gap crystals by high-intensity few-cycle laser pulses

V. Gruzdev¹, O. Sergaeva²

¹ Department of Physics and Astronomy, University of New Mexico, Albuquerque, NM, USA;

² ITMO University, St. Petersburg, Russia;

e-mail: vgruzdev@unm.edu

Ultrafast absorption of laser-pulse energy by solids transparent to low-intensity laser radiation and associated electron excitation are the key processes of ultrashort high-intensity laser-solid interactions. Simulation of those processes meets a few fundamental challenges. Numerical methods, e. g., *ab initio* simulations or direct numerical solving of the Schrodinger equation either suffer from technical issues, e. g., limited domain of simulation time, or employ oversimplified models, e. g., 1D crystals. Due to those reasons, simplified semi-analytical approaches based on a cycle-averaged rate equation are still highly popular, but they suffer from inadequate assumptions and internal contradictions. For example, they frequently combine high-collision-rate intra-band electron dynamics with zero-collision-rate inter-band dynamics under a single-frequency (quasi-monochromatic) approximation for the ultrashort laser pulses.

Many contradictions of the simplified models arise from *a priori* assumptions made about a dominating type of laser-driven electron dynamics. In absolute majority of simulations, high-rate collision-driven dynamics is assumed to dominate over non-collision coherent electron dynamics, i. e., laser-driven oscillations. Under that assumption, the rate-equation models properly fit experimental data at values of electron-particle collision time about 1 fs. This fact is considered as a justification for the high-collision-rate approximation and use of corresponding models, e. g., the Drude model. However, that collision time is significantly smaller than duration of a single optical cycle at infrared laser wavelengths and prevents use of the non-collision photoionization models, e. g., the Keldysh formula. Moreover, it is smaller than the fundamental lower limit of electron-particle collision time in a crystal.

We discuss a model of the ultrafast laser-driven inter-band and intra-band electron excitations [1,2] that is non-perturbative and is valid at high intensity; does not use a quasi-monochromatic approximations for laser radiation and can treat broad-band ultrashort laser pulses; does not from *a priori* assume high electron-particle collision rate; and is simple enough to replace the usual rate-equation models. It is built by the assumption about domination of the coherent laser-driven electron oscillations over the electron-particle collisions. The latter means the collision time must be appreciably larger than single laser cycle. Correspondingly, the effects attributed cycle-averaged energy of the oscillations (ponderomotive energy) are included, and time-dependent transient

energy bands are introduced. The Drude equation for the intra-band absorption rate is replaced with non-perturbative Vinogradov equation. Obtained results are compared with the regular rate-equation models.

This material is based upon work supported by the Air Force Office of Scientific Research under award numbers FA9550-16-1-0069 and FA9550-15-1-0254.

REFERENCES

- [1] V. Gruzdev and O. Sergaeva, Phys. Rev. B 98 (11) 115202 (2018).
- [2] O. Sergaeva, V. Gruzdev, et al, J. Opt. Soc. Am. B 35 (11), 2895-2905 (2018).

Ultrafast excitation dynamics of metals and dielectrics by ultrafast laser radiation in the UV to mid-IR spectral range

A. Horn, Ph. Lungwitz, T. Pflug and M. Olbrich

Laserinstitut Hochschule Mittweida, Schillerstraße 10, 09648 Mittweida, Germany
e-mail: horn4@hs-mittweida.de

Ultrafast metrology is a versatile tool for investigating fast processes, like laser-excitation of solid matter. Here, the excitation of a noble metal and an organic material are investigated. Irradiating thin metal films on a glass or silicon substrates using ultrafast laser radiation results in two different ablation structures, so called gentle and strong ablation structure [1, 2], depending on the applied fluence (Fig. 1 left). The principle ablation mechanisms are understood qualitatively very well, and thus, the two different ablation structures can be explained qualitatively by two-temperature hydrodynamics (TTM-HD) modeling (Fig. 1 right). For a better understanding of the included dynamics of different stages of the laser radiation material interaction ultrafast pump-probe imaging ellipsometry and reflectometry [3] for different wavelengths of the probe radiation (pulse duration $\tau_H = 60$ fs, $\lambda = 400 - 700$ nm) has been performed on thin films of gold on fused silica. The pump fluence of the pump radiation ($\tau_H = 40$ fs, $\lambda = 800$ nm) was varied within a range of $0.4 \text{ J/cm}^2 - 1.55 \text{ J/cm}^2$ to investigate the transition of no ablation to the spallation regime.

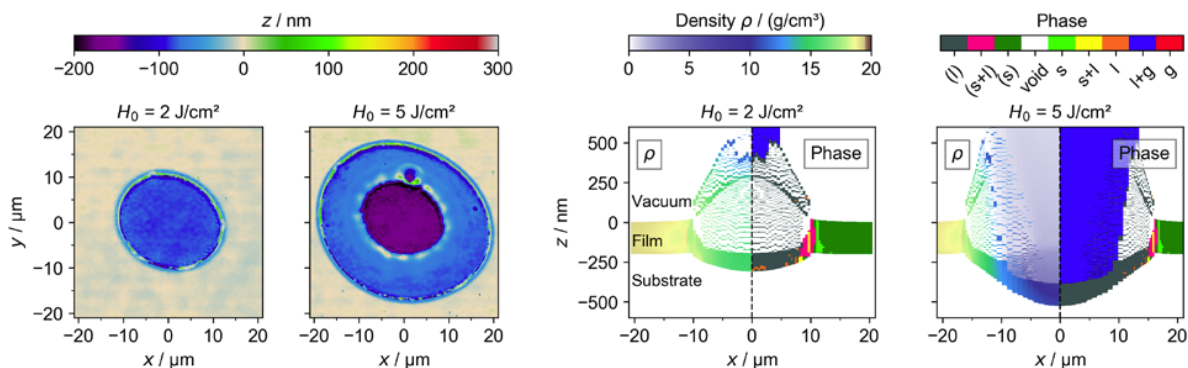

Figure 1: Ablation structures for the gentle and strong ablation regime of a thin gold film (200 nm) (left) in comparison with TTM-HD simulations for a time of 600 ps after the irradiation with ultrafast laser radiation

Exciting organic materials conventionally by ultrafast laser radiation with photon energies in the eV range, results in the decomposition of the molecular structure of the organic compounds including radical formation within the irradiated area [3]. On the other hand, a resonant infrared excitation of the vibrational modes of the organic molecules with mid-IR laser radiation features a thermal ablation of the material while preserving the chemical structure [4]. This work investigates the non-linear electronic and linear vibrational excitation of the organic dielectric PMMA during the interaction with ultrafast mid-IR

laser radiation ($3.0 \text{ um} < \lambda_{pump} < 3.8 \text{ um}$) by spatially resolved pump probe ellipsometry ($\lambda_{probe} = 800 \text{ nm}$) [5]. Irradiating PMMA with mid-IR laser radiation in the femtosecond regime ($\tau_{H;pump} \leq 50 \text{ fs}$) excites electrons via non-linear tunnel ionization [6]. As a consequence, the extinction coefficient k increases and the material is ablated independent on the wavelength of the pump radiation λ_{pump} (Fig. 2a and c). Increasing the pulse duration into the picosecond regime ($\tau_{H;pump} \leq 3 \text{ ps}$) decreases the probability for non-linear electronic excitation, and the material is only ablated when the pump wavelength equals the resonance wavelength for the C-H stretching at $\lambda_{pump} = 3.4 \text{ um}$. Therefore, no change of the extinction coefficient k is detectable (Fig. 2 b and d).

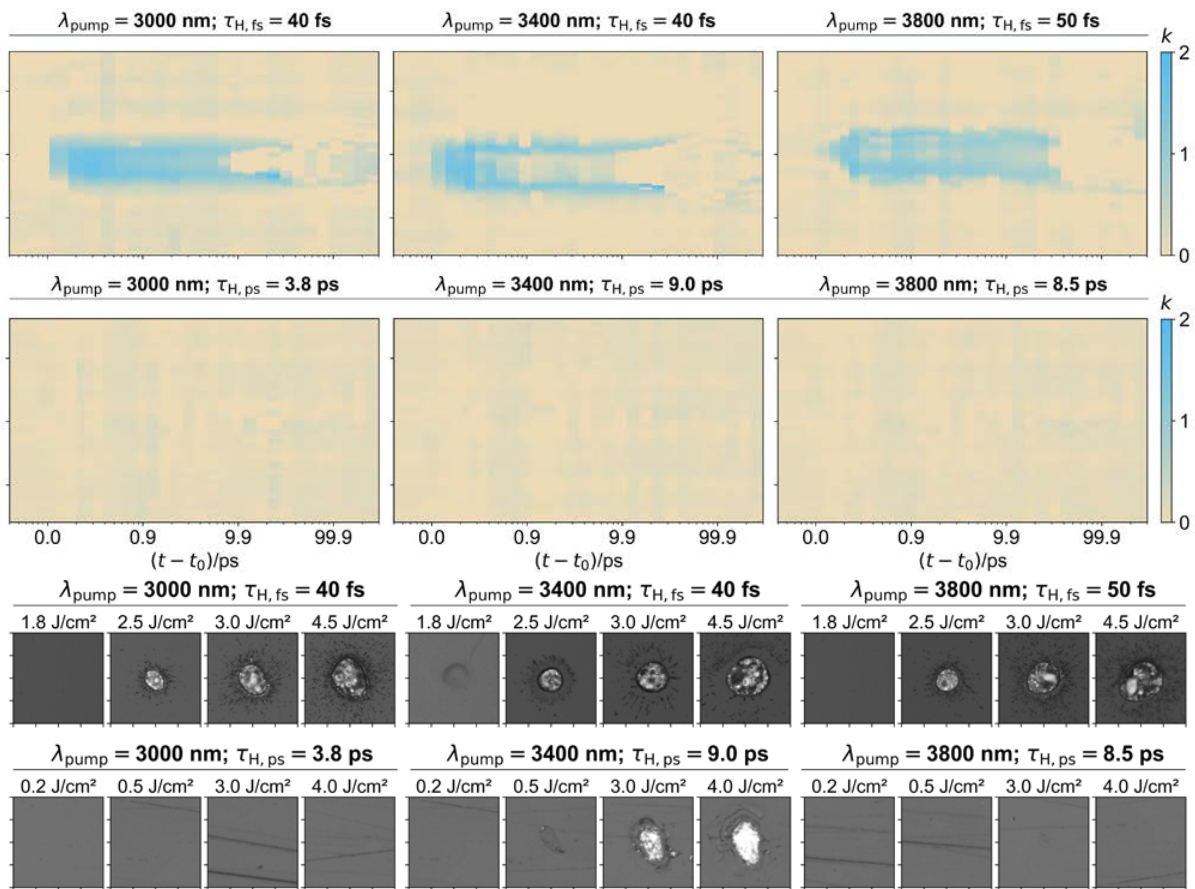

Figure 1: Extinction coefficient k of PMMA as function of time after irradiation with pump radiation (a and b); Structures generated by pump radiation at different wavelengths and pulse durations (light microscopy, c and d).

REFERENCES

- [1] M. Olbrich et al., Appl. Phys. A 122 (2016) 648.
- [2] T. Pflug et al., Appl. Phys. A 124, 17572 (2018)
- [3] M. Gebhardt et al., LTJ 10, 25 (2013).
- [4] S.L. Johnson, Resonant-infrared laser ablation of polymers, Diss., Vanderbilt Univ. (2008).
- [5] T. Pflug et al., Appl. Phys. A 124, 17572 (2018).
- [6] T. Pflug et al., Optics and Lasers in Engineering 111, 130 (2018).

Structuring of Kapton surface with ultrashort laser pulses

J. Hrabovsky^{1,2,3}, C. Liberatore¹, I. Mirza¹, J. Sladek¹, J. Beranek¹,
V. Hajkova⁴, A. V. Bulgakov¹, N. M. Bulgakova¹

¹HiLASE Centrum, Institute of Physics CAS, Za Radnicí 828, 252 41 DolníBřežany, Czech Republic;

² Faculty of Chemical Technology, University of Pardubice, Studentská 95, Pardubice Czech Republic;

³ Faculty of Mathematics and Physics, Charles University in Prague, Ke Karlovu 2027/3, 121 16 Prague;

⁴ Faculty of Nuclear Sciences and Physical Engineering, Czech Technical University in Prague, Trojanova 13, 120 00 Prague, Czech Republic

e-mail: jan.hrabovsky@hilase.cz

Nowadays there is huge demand for high precision processing of biocompatible polymers and, in particular, of polyimide for medical, electronics and industry applications. Pulsed laser ablation (PLA) is a well established method for surface processing and modification of polymers of different kinds. This process has extensively been investigated for UV region of electromagnetic spectra mainly with nanosecond laser pulses. However, polymer ablation in IR, Near- and Mid-IR spectral ranges is not widely been studied, especially in the regimes of ultrashort laser pulses when non-linear phenomena can play an important role in laser energy absorption. In this contribution, we report on a comparative study of surface structuring of polyimide (Kapton) by pico- and femtosecond laser pulses of 1030 nm wavelength. Accurate structuring of this biocompatible polymer is of importance for direct applications in prosthesis and other medical instruments. The ablation was performed with three lenses of different focal distances and the ablation thresholds have been determined. It was shown that femtosecond laser pulses are much more advantages for high-precision surface structuring compared to picosecond pulses.

Monitoring ultrafast metallization in $LaCoO_3$ with femtosecond soft x-ray spectroscopy

M. Izquierdo^{1,2}, A. Lichtenstein^{1,2,3} and S. L. Molodtsov^{1,4,5}

¹ European XFEL GmbH, Holzkoppel 4, 22869 Schenefeld, Germany

² Institut für Theoretische Physik, Universität Hamburg;

³ Ural Federal University, 620990 Yekaterinburg, Russia

⁴ Institute of Experimental Physics, Technische Universität Bergakademie Freiberg, 09599 Freiberg, Germany

⁵ ITMO University, Kronverkskiy pr. 49, 197101 St. Petersburg, Russia

e-mail: manuel.izquierdo@xfel.eu

The study of ultrafast dynamics is a new tool to understand and control the properties of correlated oxides, opening new routes for technological applications. $LaCoO_3$ (LCO) is one example where the strong electron, spin, and lattice coupling induced by electronic correlations results in a low-temperature low spin (LS) to high spin (HS) transition and a high-temperature semiconductor-to-metal transition (SMT) that are still not completely understood. In this contribution, the SMT is addressed in view of its technological relevance in environmentally friendly energy production domains (see Refs. 24-31 in [1]). DFT+DMFT calculations of the optical reflectivity and time-resolved optical pump-soft x-ray probe experiments with femtosecond resolution have been combined to understand the properties of the laser-induced transient metallic state and the interplay between the electronic, spin, and lattice degrees of freedom. The theoretical optical conductivity has provided insight into the electronic properties of the laser-excited transient metallic state and the excitation mechanism. Pump-probe experiments using an optical pump at 800 nm and a soft x-rays probe at resonant energies of the Co L_3 and O K edges have been performed. The delay scans show intensity variations at different time delays for different resonant energies indicating that the ultrafast metallization takes place within 3 ps via charge, spin and lattice separation. The 800 nm optical laser excitation depopulates electrons from the pseudo- t_{2g} orbitals into the pseudo- e_g ones. As a consequence, charge transfer between the pseudo- e_g and the O-2p orbitals is enhanced and the HS state population increases. The larger ionic radius of the HS state induces a lattice distortion with modification of the bond angles and interatomic distances in the CoO_6 octahedra that explain the metallic character of LCO at high temperature. It is interesting to note that, while the process is entangled at the Co L edge, the time information of the different channels involved is decrypted at different resonant energies of the O K edge. The emerging picture presents the transient metallization as a four-step process in a way similar to the ionic model proposed by Goodenough to explain the evolution of LCO with temperature. Our studies become thus the first experimental demonstration of Goodenough metallization model [2]. The laser excitation enhances the

charge disproportionation of the system already present under thermodynamical equilibrium conditions. The experiments support the theoretical DFT+DMFT model that favors correlation-induced charge and spin fluctuations with moderate U . Furthermore, the results indicate that a comprehensive analysis of the ultrafast dynamics of perovskites can be obtained by performing time-resolved experiments with soft x-rays at the O K only.

REFERENCES

- [1] M. Izquierdo, M. Karolak, D. Prabhakaran, A. T. Boothroyd, A. O. Scherz, A. Lichtenstein and S. L. Molodtsov, *Communication Physics*, 2:8 (2019).
- [2] P. M. Raccah and J. B. Goodenough, *Phys. Rev.*, 155, 932 (1967).

Plasmonic and carrier-envelope-phase effects in laser-plasma terahertz generation

V. A. Kostin^{1, 2}, I. V. Osovitskaya^{1, 2}, and N. V. Vvedenskii^{1, 2}

¹Institute of Applied Physics, Russian Academy of Sciences, Nizhny Novgorod, Russia;

²University of Nizhny Novgorod, Nizhny Novgorod, Russia

e-mail: vk1@ipfran.ru

The direct conversion of femtosecond ionizing laser pulses into low-frequency radiation attracts considerable attention due to associated possibilities for creating sources of powerful broadband terahertz (THz) pulses. For one-color ionizing pump pulses, previous studies of this phenomenon were mainly related to two limiting cases: (i) few-cycle (extremely short) ionizing pulses and (ii) multicycle (quasimonochromatic) pulses. In the first case, the amplitude and energy of THz oscillations strongly depend on the carrier-envelope phase (CEP) in the ionizing pulse [1, 2], whereas for multicycle pulses the CEP dependence was not found [3–5]. The spectral and mode structures of generated radiation also differ in these two cases. For the few-cycle pulses, the plasmonic oscillations corresponding to the dipole geometric resonance are excited and emitted from the laser-produced plasma filament to the surrounding space. For multicycle pulses, the radiation is produced by a relaxing current directed along the plasma filament, and the spectrum width and central frequency are determined by the collision frequency of electrons with heavy particles. Thus, the shape of low-frequency spectrum strongly depends on the pump pulse duration, and there is a range of durations where transition between different spectral shapes occurs. In this range of durations, the spectrum shape also significantly depends on the CEP, as was apparently observed in experiment [6]. In this work, we focus on this intermediate case, analyzing possible plasmonic regimes of laser-plasma terahertz radiation (with various plasmonic modes involved). Based on the two-stage approach [2, 5] for laser-plasma terahertz generation, we develop a universal model that considers the motion of the plasma electrons under forces both linear and quadratic in the optical field strength. Using this model, we show that in axisymmetric ionizing beam, both the residual current density (RCD) and the terahertz radiation induced by it can be considered as a superposition of components with different azimuthal structures with main contribution from dipole (with 1 azimuthal variation) and quadrupole components (with 0 or 2 variations). These azimuthal components are made of different plasmonic modes and depend differently on the CEP and duration of the ionizing pump. We determine different regimes of generation (with different dominating plasmonic modes) and describe how the duration and phase structure of the ionizing pulse can affect not only the terahertz energy, but also the terahertz spectrum due to competition between these modes.

This work was supported by the Russian Foundation for Basic Research (Grant Nos. 18-02-01150 and 18-32-00951).

REFERENCES

- [1] M. Kreß, T. Löffler, M. D. Thomson, et al., *Nat. Physics*, 2 (5), 327 (2006).
- [2] V. B. Gildenburg, N. V. Vvedenskii, *Phys. Rev. Lett.*, 98 (24), 245002 (2007).
- [3] T. Löffler, F. Jacob, H. G. Roskos, *Appl. Phys. Lett.*, 77 (3), 453 (2000).
- [4] C. D'Amico, A. Houard, M. Franco, et al., *Phys. Rev. Lett.*, 98 (23), 235002 (2007).
- [5] V. A. Kostin, N. V. Vvedenskii, *Opt. Lett.*, 35 (2), 247 (2010).
- [6] Y. Bai, L. Song, R. Xu, C. Li, et al., *Phys. Rev. Lett.*, 108 (25), 255004 (2012).

Penetration of a monochromatic electromagnetic wave in the plasma formed by multiphoton ionization of gas atoms

K. Yu. Vagin¹, T. V. Mamontova^{1,2} and S. A. Uryupin^{1,2}

¹P.N. Lebedev Physical Institute of the Russian Academy of Sciences, Moscow, Russia;

² National Research Nuclear University MEPhI, Moscow, Russia;

e-mail: mamontova.tat.v@gmail.com

The features of penetration of a monochromatic electromagnetic (EM) wave during its normal incidence on the plasma, obtained as a result of multiphoton ionization of gas atoms, were studied and spatial structure of electric field in plasma was obtained.

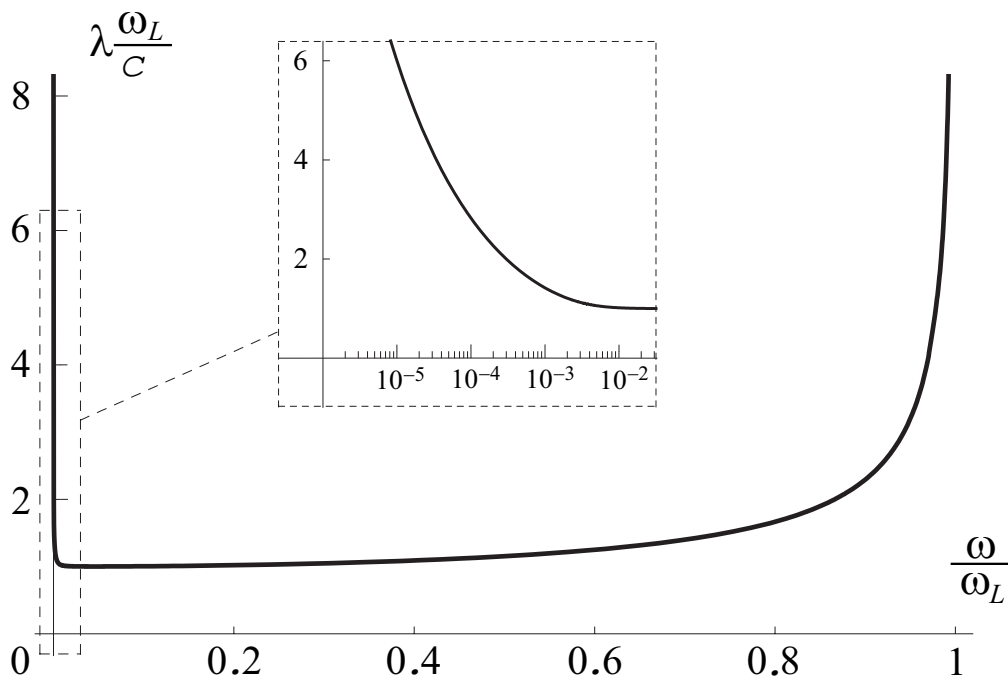

Figure 1: The dependence of the wave penetration effective depth λ on its frequency ω .

It turned out that the depth of penetration of the wave in a wide range of incident wave frequencies ω smaller than Langmuir frequency of electrons ω_L varies slightly. However, as the frequency approaches zero or ω_L , the depth begins to noticeably increase (see Fig.1). Two cases of electric field in plasma were obtained analytically for different relation between depth of electric field penetration and a distance passed by a photoelectron over a period of wave. It was found that in the high-frequency case the magnitude of electric field decreases exponentially on the electromagnetic scale c/ω_L which is the characteristic scale of a high-frequency skin effect [1]. In this case distance passed by an electron over period of wave much smaller than the electric field changing scale in plasma. At low frequencies, an EM wave penetrates into the plasma over distances corresponds to scale of the anomalous skin effect λ_a . Decreasing of electric field magnitude on a greater depth than λ_a occurs according to the inverse power law

over of distance. That is due to strong spatial dispersion caused by photoelectron motion. However, the absolute value of penetration field is much smaller than the magnitude of incident wave.

In the both cases field absorption is weak and connected with spatial dispersion induced by the photoelectron motion.

REFERENCES

- [1] V. P. Silin, A. A. Rukhadze, *Electromagnetic Properties of Plasma and Plasma-Like Media* (in Russian), Librokom, Moscow, 2018

Control of absorbed energy density and electron concentration via two color femtosecond excitation of solids

E. A. Migal¹, E. I. Mareev¹, E. O. Smetanina^{2,3}, G. Duchateau³,
F. V. Potemkin¹

¹ Faculty of Physics and International Laser Center, M. V. Lomonosov Moscow State University, Moscow 119991, Russia;

² Department of Physics, University of Gothenburg, SE-412 96 Göteborg, Sweden;

³ Université Bordeaux, Centre National de la Recherche Scientifique, CEA, Centre Lasers Intenses et Applications, UMR 5107, 33405 Talence, France;

e-mail: ea.migalj@physics.msu.ru

Direct fabrication of nanoscale structures in bulk material is of significant importance for miniaturization of photonic and optoelectronic devices. Although using photolithography structures of several tens of nanometers can be achieved, low-cost widely available methods are still desired. Ultrafast lasers are a promising tool for direct writing of nanometer defects due to highly nonlinear nature of process [1,2]. However, due to diffraction limit, the minimal size of the structures obtained under single color excitation is still of the order of λ/NA , λ is laser wavelength and NA is numerical aperture of the focusing optics.

In contrast multi-color laser beams allow for precise control of structuring by dividing the excitation process into two steps [3,4]. Firstly, UV or visible pulse creates seed electrons. Subsequently IR pulse arrives and induces damage through efficient initiation of avalanche ionization. The significant importance of this approach is the capability of reaching high deposition energy density simultaneously with minimal defect sizes since energy of both pulses (visible and IR) is below the damage threshold [5].

In this paper we present our latest experimental and theoretical results aiming on the optimization of laser pulses parameters (energy, wavelength, polarization). We show that the highest deposited energy is reached when the energy of both pulses is close to single color threshold of plasma generation. The use of the second pulse with longer wavelength significantly increases absorbed energy due to more efficient heating of the quasi-free electrons in the conduction band. Elliptical polarization of the long wavelength pulse is additionally increase absorbed energy.

REFERENCES

- [1] R. R. Gattass and E. Mazur, *Nat. Photonics* 2(4), 219-225 (2008).
- [2] M. Ali, T. Wagner, M. Shakoor, and P. A. Molian, *J. Laser Appl.* 20(3), 169-184 (2008).
- [3] X.Yu et al., *Optics Express* 21(20), 24185-24190 (2013).
- [4] F. V. Potemkin et al, *Laser Physics Letters* 13(4), 045402 (2016).
- [5] F. Potemkin et al., *Applied Physics Letters* 110(16), 163903 (2017).

Towards measurements of attosecond electron dynamics in high-order harmonic generation from solids

V. E. Nefedova, S. Fröelich and H. Merdji

Ultrafast Nanophotonics group, CEA Saclay/IRAMIS/LIDYL/Atto, Gif-sur-Yvette, France
e-mail: viktorina.nefedova@cea.fr

The electronic current dynamics occurring during the laser interaction with a dielectric or a semiconductor leads to emission of harmonics up to the XUV regime [1-3]. The phenomenon of high-order harmonic generation (HHG) is a coherent process which corresponds in real time to petahertz electronic oscillations. This contribution will summarize recent results on HHG from MgO crystal in XUV spectral range as well as draw perspectives for attosecond phase characterization. In HHG, the measurement of the spectral phase has been a crucial step in understanding the electron dynamics under strong field. Here, we will present a development of a novel RABBIT (Reconstruction of attosecond beating by interference of two photon transitions) setup to investigate the attosecond timing of the electron current at low photon energy (UV to XUV). This is relevant for the metrology of optoelectronic switches operating in the petahertz regime. In addition, we aim at investigating the underlying mechanisms that govern semiconductor HHG. For example, inter- and intra-band processes or structural changes can be discriminated through their relative attosecond phase.

REFERENCES

- [1] Ghimire, S. et al., Nature Physics 7, 138 (2011)
- [2] Luu, T. T. et al., Nature 521, 498 (2015)
- [3] Ndabashimiye, G. et al., Nature 534, 520 (2016)

Attosecond electron dynamics in solids – toward petahertz-scale solid state technology

K. Oguri, H. Mashiko, K. Kato and H. Gotoh

NTT Basic Research Laboratories, NTT Corporation, 3-1 Morinosato Wakamiya, Atsugi, Kanagawa 243-0198, Japan
e-mail: katsuya.oguri.hf@hco.ntt.co.jp

Lightwave-field controlled electronic response in solid state materials is the key concept for pioneering future unprecedented ultrafast functionalities of solid state devices with an operational speed corresponding to light-wave frequency, namely petahertz (PHz: 10^{15} Hz) [1]. In contrast to conventional optical devices based on the cycle-averaged-intensity-driven electronic response, the coherent electronic motion driven by lightwave field and its decoherence and relaxation occurring on the time scale comparable to a single cycle of lightwave, typically a few fs, play an essential role for such petahertz device operation. From this point of view, we have been developing various spectroscopic techniques based on a high-order harmonic extrem ultraviolet (EUV) attosecond pulse source that enable us to capture the dynamical electrons in both energy and momentum space with an unprecedented temporal resolution of from a few femtosecond down to attosecond scale (Fig. 1) [2].

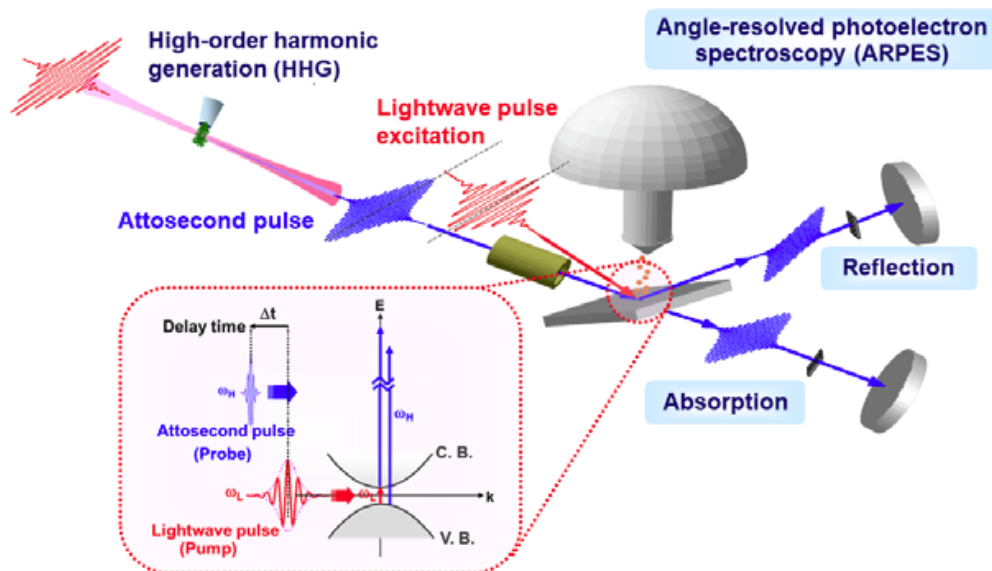

Figure 1: Schematic illustration of attosecond time-resolved spectroscopy. High-order harmonic pulse with a few femtoseconds down to a few hundred attoseconds detects the instantaneous lightwave-driven electronic excitation and relaxation between the valence (V. B.) and conduction (C. B.) bands as optical or photoelectronic signal modulation.

A typical example is a coherent electronic dipole oscillation induced by lightwave field, which is the most fundamental light-matter interaction. An attosec-

ond time-resolved absorption spectroscopy technique reveals the oscillating superposition state of electric interband transition between the valence band and the conduction bands [3]. We demonstrated a time-domain observation of the third-order nonlinear dipole oscillation in GaN wide-gap semiconductor. We also extended our attosecond spectroscopic technique to direct dynamical mapping of electronic band by time-resolved angle-resolved photoemission spectroscopy (ARPES) based on sub-5-fs harmonic source. This technique captured the earliest stage of relaxation from the initially formed electronic population via the interband transition in graphite. Exploring attosecond electron dynamics in various solid state materials by developing new type of attosecond spectroscopic techniques provides the foundation for the future petahertz-scale solid state technology.

This work was partially supported by JSPS KAKENHI Grant No. 25706027, 23310086, 16H05987, and 16H02120.

REFERENCES

- [1] F. Krausz, and M. I. Stockman, *Nature Photon.* 8, 205 (2014); M. Schultze, et al., *Nature* 493, 75 (2013); Higuchi et al., *Nature* 550, 224 (2017).
- [2] K. Oguri et al., *Opt. Lett.*, 29, 1279 (2004); H. Mashiko et al., *Nat. Commun.* 5, 5599 (2014); K. Oguri et al., *Applied Phys. Express* 8, 022401 (2015).
- [3] K. Oguri et al., In K. Yamanouchi et al., (Eds.) *Progress in Ultrafast Intense Laser Science XIV*, Chap. 12, Springer (2018); H. Mashiko et al., *Nat. Phys.* 12, 741 (2016); H. Mashiko et al., *Nat. Commun.* 9, 1468 (2018).

Graphene in strong optical and THz fields

I. V. Oladyshkin, S. B. Bodrov, Yu. A. Sergeev, A. I. Korytin, M. D. Tokman
and A. N. Stepanov

Institute of Applied Physics of the Russian Academy of Sciences, Nizhny Novgorod, Russia;
e-mail: oladyshkin@gmail.com

The nonlinear optics of graphene is actively investigated due to its prospective use in plasmonics, optoelectronics, and photonics. The key features of gapless dispersion of Dirac fermions make graphene a unique material. Close to the Dirac point, fermions have a massless dispersion law up to energies of 1.5 eV and high Fermi velocity, thus providing very high nonlinear susceptibility (both quadratic and cubic) in the infrared and terahertz wave ranges.

The first part of talk will be devoted to the experimental observation of spontaneous optical emission of graphene induced by an intense terahertz (THz) pulse [1]. P-doped chemical-vapor-deposition graphene with an initial Fermi energy of about 200 meV was used; optical photons were detected in the 2.0-3.5 eV range. Emission started when the THz field amplitude exceeded 100 kV/cm. For the THz fields from 200 to 300 kV/cm, the temperature of optical radiation was constant, while the number of emitted photons increased by several dozen times. This fact clearly indicates multiplication of electron-hole pairs induced by an external field and not electron heating. The experimental data are in good agreement with the theory of Landau-Zener interband transitions.

We also observed enhanced second harmonic generation in monolayer graphene in the presence of a strong terahertz field of picosecond duration [2]. This is a strongly nonperturbative regime of light-matter interaction in which particles get accelerated to energies exceeding the initial Fermi energy of 0.2 eV over a timescale of a few femtoseconds. The resulting strongly asymmetric distortion of carrier distribution in momentum space gives rise to an enhanced electric-dipole nonlinear response at the second harmonic. We develop an approximate analytic theory of this effect which accurately predicts observed intensity and polarization of the second harmonic signal.

This work was supported by the grant of the Government of the Russian Federation (“Megagrant“ program, project No 14.W03.31.0032); I.O. is grateful to the Foundation for the Advancement of Theoretical Physics “Basis“ for support.

REFERENCES

- [1] I. V. Oladyshkin et al., PRB 96, 155401 (2017)
- [2] M. Tokman et al., PRB 99, 155411 (2019)

Detection of buried gratings underneath optically opaque layers using ultrafast electron dynamics and ultrafast photo-acoustics

S. Edward^{1,2}, V. Verrina^{1,2}, H. Zhang^{1,3}, A. Antoncechi^{1,3}, S. Witte^{1,3},
P. C. M. Planken^{1,2}

¹ Advanced Research Center for Nanolithography (ARCNL), Science Park 106, 1098 XG Amsterdam, The Netherlands

² Van der Waals-Zeeman Institute, University of Amsterdam, Science Park 904, 1098 XH Amsterdam, The Netherlands

³ Department of Physics and Astronomy, Vrije Universiteit, De Boelelaan 1081, 1081 HV Amsterdam, The Netherlands
e-mail: p.c.m.planken@uva.nl

In semiconductor device manufacturing, it is often necessary to optically detect the presence of micro/nano structures buried underneath many dielectric and metallic layers. An example of a buried structure is a so-called alignment grating, which is a grating etched in Si. When light is diffracted off such a grating, a small change in position of the wafer changes the phase difference between the -1^{st} and $+1^{st}$ order diffracted light beams, which can be used to determine the position of the wafer with great accuracy. However, when optically opaque dielectric and metallic layers are deposited on top of these gratings, it becomes very difficult to detect them.

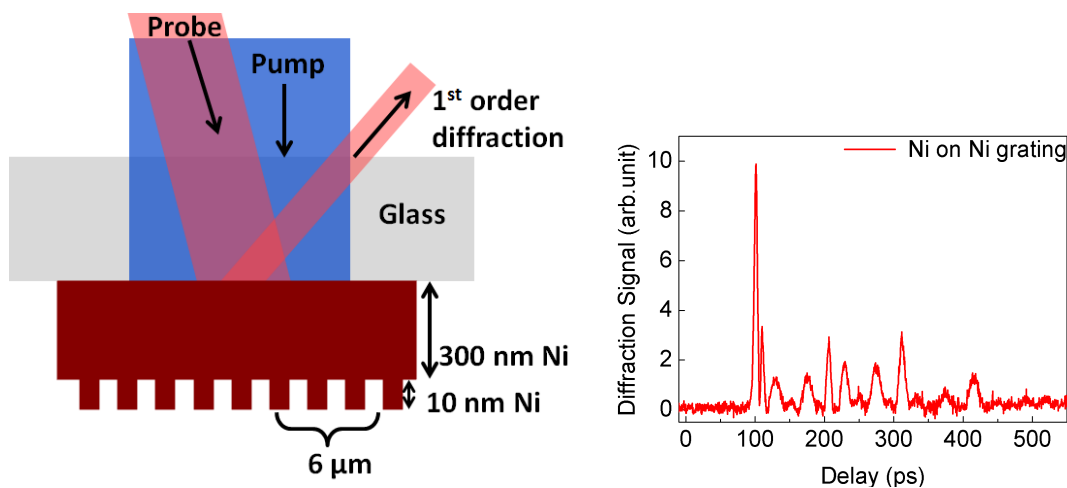

Figure 1: (a, left) Schematic of a buried 10 nm amplitude Ni grating on 300 nm of Ni on glass. Pump and probe pulses illuminate the sample from the glass side. (b, right) The experimentally measured diffracted probe signal vs pump-probe delay for the Ni on Ni grating sample.

Here, we show that ultrafast electron dynamics[1] and extremely high-frequency photoacoustics [2, 3, 4] can be used to detect the presence of a grating buried underneath optically opaque metallic and dielectric layers. In our photoacoustic experiments, a femtosecond 400 nm pump-pulse illuminates a metal and launches an acoustic wave that propagates into the layered structured and reflects off an optically buried metallic grating. The acoustic wave returning to

the surface/interface has the spatial periodicity of the buried grating imprinted on the phase of the acoustic wave. An 800 nm wavelength probe pulse diffracts off the acoustic grating and the first-order diffracted beam is measured.

A schematic example of a fabricated structure is shown in Fig. 1(a). In this case the structure is made of a 10 nm amplitude Ni grating on top of a 300 nm Ni layer on glass. By pumping and probing from the glass side, the grating is invisible to the light, and can be considered a “buried” grating. The measured diffracted signal vs. pump-probe time delay is shown in Fig. 1(b). The onset of diffraction near a delay of 100 ps, the acoustic roundtrip time in 300 nm Ni, is evidence that the buried grating is detected through the acoustic “copy”. In this presentation, results obtained on far more complicated samples consisting of tens of layers, as well as the dependence on buried grating amplitude (down to 1 nm) and linewidth (as small as 75 nm) will be shown and discussed.

REFERENCES

- [1] S. Edward, A. Antoncetti, H. Zhang, H. Sielcken, S. Witte, P. C. M. Planken, *Opt. Express* 26, 23380 (2018).
- [2] Kovalenko et al. 10.1364/CLEO_QELS.2013.QTh3E.5.
- [3] T. Saito, O. Matsuda, and O. B. Wright, *Phys. Rev. B* 67, 205421 (2003)

Response of nonequilibrium nonstationary plasma created by an intense femtosecond UV laser pulse in rare gases to the emission of the THz frequency band THz

A. V. Bogatskaya^{1,2}, E. A. Volkova¹ and A. M. Popov^{1,2,3}

¹ Skobeltsyn Institute of Nuclear Physics, Moscow State University, Moscow, Russia;

² Lebedev Physical Institute, RAS, Moscow, Russia;

³ Physics Department, Moscow State University, Moscow, Russia;

e-mail: alexander.m.popov@gmail.com

We develop the new model for analyzing ultrashort terahertz pulse propagation in nonequilibrium nonstationary plasma channels [1]. The response of the plasma to the terahertz frequency band radiation is investigated on the basis of the kinetic Boltzmann equation for the temporal behavior of the electron velocity distribution function (EVDF) in an arbitrary external electric field and allows to take into account both temporal retardation of the EVDF evolution with respect to the external electric field and the effect of the relaxation of the strongly nonequilibrium EVDF due to elastic electron - atomic collisions in nonequilibrium and nonstationary plasma formed in gases by multiphoton ionization by UV laser radiation. The possibility of THz pulse amplification is analyzed in dependence on THz pulse and plasma parameters. Proposed model is highly suitable to be incorporated in the self-consistent analysis for short THz pulse propagation in a plasma channel based on joint solution of Boltzmann equation for EVDF in a plasma and wave equation beyond the paraxial approximation [2].

Further we are going to develop this approach for analysis of THz pulse propagation in plasma channels with higher electron density when electron-electron collisions are of importance and provide more rapid relaxation of energy spectrum in plasma. Rapid relaxation of the spectrum also take place in the air (or nitrogen) plasma where the effect of amplification of extremely short THz is also possible.

This work was supported by the Russian Science Foundation (project no. 18-72-00125).

REFERENCES

- [1] A. V. Bogatskaya and A. M. Popov Laser Phys. Lett., vol.16, (2019) accepted for publication
- [2] A. V. Bogatskaya, E. A. Volkova and A. M. Popov Laser Phys., vol.29, (2019) submitted.

Femtosecond X-ray laser pulse induced effects in solids

N. Medvedev^{1,2}, V. Tkachenko³

¹ Institute of Physics CAS, v.v.i., Na Slovance 2, 182 21 Prague, Czech Republic;

² Institute of Plasma Physics CAS, v.v.i., Za Slovankou 3, 182 00 Prague, Czech Republic; ³ DESY, Germany

e-mail: nikita.medvedev@fzu.cz

This talk will briefly review the results of our theoretical research on damage mechanisms in various materials irradiated with femtosecond free-electron-laser pulses at fluences ranging from mild excitation of the target to warm dense matter formation. Various damage mechanisms are discussed on examples of insulators (e.g. diamond [1]), semiconductors (e.g. silicon [2]), metals (e.g. gold). They are studied with a developed hybrid approach, XTANT (X-ray-induced Thermal And Nonthermal Transitions [3]), which includes nonequilibrium kinetics of electrons modeled within a combination of the Monte Carlo simulation and Boltzmann kinetic approach, nonthermal effects in the atomic system traced within tight-binding molecular dynamics, and nonadiabatic coupling between the systems.

We analyze the effects of thermal melting of targets as a result of electron-ion energy exchange; nonthermal phase transitions due to modification of the interatomic potential (such as nonthermal melting in silicon or solid-solid phase transition in irradiated diamond); spallation or ablation at higher fluences due to detachment of sample fragments; and a complex multistep kinetics of warm dense matter formation [4]. As a result, we demonstrate that diamond upon femtosecond pulse irradiation turns into graphite within 150-200 fs, in a very good agreement with experimental data [1]. Silicon [2] as well as AlAs [5] can melt both, thermally or nonthermally, into two different liquid phases. We also find that the electron-ion (electron-phonon) coupling parameter can be accessed in highly-excited samples via pump-probe time-resolved measurements of optical properties [2].

REFERENCES

- 1] F. Tavella et al., High Energy Density Phys. 24, 22 (2017).
- [2] N. Medvedev, Z. Li, V. Tkachenko, and B. Ziaja, Phys. Rev. B 95, 014309 (2017).
- [3] N. Medvedev, V. Tkachenko, V. Lipp, Z. Li, and B. Ziaja, 4open 1, 3 (2018).
- [4] N. Medvedev and B. Ziaja, Sci. Rep. 8, 5284 (2018).
- [5] N. Medvedev, Z. Fang, C. Xia, and Z. Li, Phys. Rev. B 99, 144101 (2019)

Electronic sound waves in plasma formed by above-threshold ionization of gas atoms

K. Yu. Vagin¹, T. V. Mamontova^{1,2}, and S. A. Uryupin^{1,2}

¹ P.N. Lebedev Physical Institute of RAS, Moscow, Russia;

² National Research Nuclear University MEPhI (Moscow Engineering Physics Institute), Moscow, Russia

e-mail: vagin@sci.lebedev.ru

In experimental studies of above-threshold ionization (ATI) of gas atoms by short laser pulses it was found that the energy spectrum of forming photoelectron distribution may consists of a set of individual peaks. Each peak corresponds to the absorption of a certain number of photons and with increasing ionizing radiation intensity, the number of peaks grows up (see, e.g., [1]). The properties of non-equilibrium plasmas formed by ATI of gases differ from the properties of plasmas with an electron distribution close to the Maxwellian. Dispersion and dissipative properties of longitudinal waves in plasma with the single energy peak formed by multiphoton ionization of gases were studied in the paper [2].

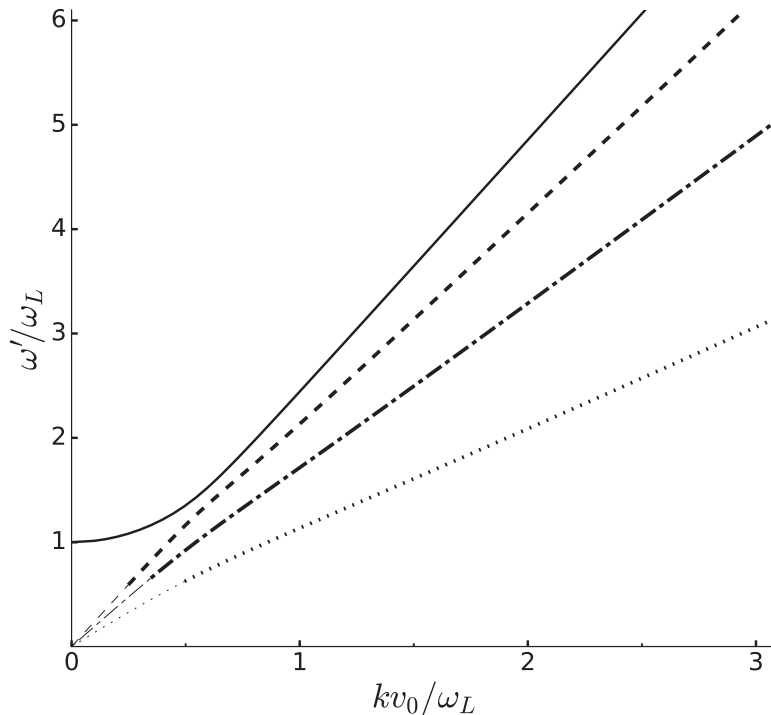

Figure 1: The dependencies of the dimensionless plasma waves frequencies on the dimensionless wave number in photoionized plasma with four energy peaks in the photoelectron distribution.

In this report we considered the case of relatively weak ionizing laser pulse with intensity $\sim 10^{12} \text{W/cm}^2$, when the number of energy peaks in the photoelectron distribution in the ATI regime is not large. It is shown that the number

of longitudinal waves in such plasma coincides with the number of peaks in the distribution function. When peaks practically don't overlap, the dispersion law of each wave in the short wave region is determined by photoelectrons from the corresponding peak and has linear form. In this case the phase and group velocities of the waves are close to the photoelectron velocity v_0 , which corresponds to the energy peak maximum. It is possible to talk about such waves as an electronic sound, since the perturbations of the electron density mainly arise due to pressure perturbations. When the peaks are narrow, but having a finite width, the Cherenkov damping of waves is exponentially small. The dispersion laws for the two longitudinal waves in photoionized Xe plasma with two narrow peaks in photoelectron distribution are found analytically. Similar dispersion laws for four waves in the Xe plasma formed by more intense laser pulse, and having four peaks in photoelectron distribution are calculated numerically.

REFERENCES

- [1] G. Petite et al. J. Opt. Soc. Am. B 4 765 (1987).
- [2] K.Yu.Vagin et al., Contributions to Plasma Physics 58 276 (2018).

Intraband absorption of femtosecond light pulses in crystals induced by acoustic and longitudinal optical phonon-assisted processes

M. O. Zhukova¹ and E. Yu. Perlin¹

¹ ITMO University, St. Petersburg, Russia;
e-mail: mozhukova@corp.ifmo.ru

Ultrashort high-power laser pulses are frequently used in experiments on optical excitation of solid-state materials. Multiphoton interband transitions occur and result in a large density of free carriers as high as 10^{18} – 10^{20} cm⁻³ [1]. Consequently, single- and multiphoton intraband transitions become more significant. In these conditions, new treatment of intraband light absorption induced by longitudinal optical (LO) and acoustic (LA) phonons becomes appreciable.

The first part of this work is related to the interband transition probabilities under the action of the quasi-stationary field. This goal occurs from the need to clarify the error in the composite matrix element for the second-order process in well-known sources [2] of literature and to expand the range of considered frequencies to visible and NIR.

The simple procedure for calculating the light absorption coefficient for free electrons in intraband transitions involving LO and LA phonons over a wide range of light frequencies and arbitrary electron densities for visible and near IR ranges is provided [3]. As numerical estimates, the frequency and temperature dependences of the intraband absorption coefficients for a ZnSe crystal are demonstrated.

Presented dependences of the absorption coefficient on the frequency of light and temperature show that at high concentrations of free carriers in the visible and near IR ranges, the number of intraband transitions proves to be very impressive even at temperatures close to room ones [4].

In the second part, we put our attention on taking into account the pulse duration of laser pulses. For fs pulses the duration of light pulse (less than 100 fs, for example) is smaller than the relaxation time of the charge-carrier momentum common way becomes unacceptable. The theory of nonstationary absorption of fs pulses by free electrons on intraband transitions assisted by phonons will be described [5].

Estimates for ZnSe crystal show that for the energy densities in the pulse around 10 mJ/cm², the probabilities of processes involving a different number of photons are comparable, which leads to an effective 'smearing' of the electron gas over the Brillouin zone. For higher energy densities it is necessary to take into account the processes of reemission of photons.

To show the applicability of this treatment the efficiency of cascade [6,7] and multiphoton treatment will be compared.

REFERENCES

- [1] L. Englert, B. Rethfeld, L. Haag, M. Wollenhaupt, C. Sarpe-Tudoran, T. Baumert, *Optics Express*, 15 (26), 17855–1786 (2007).
- [2] A. I. Ansel'm, *Introduction to Semiconductor Theory*, Nauka (1978).
- [3] M.O. Osipova, E.Yu. Perlin, *Journal of Optical Technology*, 83 (6), 329–331 (2016).
- [4] M.O. Zhukova, E.Y. Perlin, In *2017 Progress In Electromagnetics Research Symposium (PIERS)*, 3102–3104 (2017).
- [5] E.Yu. Perlin, M.A. Bondarev, M.O. Zhukova, *Optics and spectroscopy*, 123 (4), 583–586 (2017).
- [6] B. Rethfeld, A. Kaiser, M. Vicanek, G. Simon, *Physical Review B*, 65 (21), 214303 (2012).
- [7] N. Brouwer, B. Rethfeld, *Physical Review B*, 95 (24), 245139 (2017).

Ab initio analysis of the laser-induced ultrafast structural response in silicon

T. Zier¹ and M. E. Garcia^{1,2}

¹ Theoretical Physics, University of Kassel, 34132 Kassel, Germany;

² Center for Interdisciplinary Nanostructure Science and Technology (CINSaT), Kassel, Germany
e-mail: zier@uni-kassel.de

Recent developments showed that femtosecond-laser pulses are an ideal tool to address and/or manipulate properties in matter, since pulse durations are comparable to typical time scales of atomic motions in molecules and solids. In general, the excitation of a crystalline material by an intense ultrashort laser pulse creates extreme nonequilibrium conditions within the solid. The optical energy of such an excitation is, due to the high difference in the coupling strength of light to electrons and atoms, mainly deposited in the electronic system. Therefore, one can induce electronic temperatures in materials of several 10000 K, whereas the atomic system remains almost unaffected near room temperature. Such an immense change in the electronic system has a direct influence on the bonding properties of the material. This laser-induced change in the atomic bonding is the underlying driving force for ultrafast phenomena, like, thermal phonon squeezing, solid-to-solid phase transitions, and solid-to-liquid phase transitions. In order to resolve the atomic pathways and the energy flow during these structural responses, we performed ab initio molecular dynamics simulations with our in-house code CHIVES for materials in both, bulk and thin film geometry. Our results on laser-excited silicon enabled to identify microscopic atomic mechanisms of laserinduced nonthermal melting. Additionally, our simulations enabled us to propose an excitation mechanism that allows to control the structural response in the high excitation regime.

Using photoacoustic effect from train of ps-pulses for monitoring of laser ablation processes

A. E. Zubko¹, A. A. Samokhin¹, E. V. Shashkov¹ and N. S. Vorob'ev¹

¹ Prokhorov General Physics Institute of the Russian Academy of Sciences, Moscow, Russia;
e-mail: aleksey.zubko11@gmail.com

In ref. [1] it was shown that recoil pressure behavior in condensed matter (absorbing dielectric liquids) due to action of nanosecond laser pulses with harmonically modulated intensity contains information about the pressure and ablation rate behavior. The ablation rate or irradiation surface displacement can be found from comparison between modulated parts of laser intensity and pressure signals which are different because of acoustical Doppler effect and some other reasons. For metals pulsed intensity modulation (due to mode locking) seems to be more preferable than harmonic modulation to avoid interference effect between thermoacoustic and vaporization mechanisms of pressure generation [2, 3] which also contributes to the difference τ between corresponding pulse maxima in modulated parts of laser and pressure signals. First demonstration of pressure behavior generated in metal target under the nanosecond train of picosecond laser pulses (60 ps with intervals 8 ns) action was reported in [4] at relatively slow laser fluences. In this case the measured difference τ is affected, in particular, with temperature dependence of sound velocity in target heated region while ablation displacement of irradiated surface is small [5]. The ablation can be enhanced with the help of additional (unmodulated) nanosecond laser pulse as it was done in [5] where the additional pulses irradiated the target in-between the subsequent trains. At higher intensities the ablation process can be followed with plasma formation in vapor plume and ambient air.

In the present study more intensive laser trains (14 pulses in the train) are used which give rise to the plasma formation even without the additional unmodulated pulses. Thermal emission from the arising plasma is detected with the help of Hamamatsu C1083 PIN diode. The detectable emission appears approximately at the same fluence as detectable ablation when $\tau_a \sim 50$ ps. Just above this threshold $E_{th} \sim 1$ J/cm² plasma emission between the pulses of the train is absent except for an interval not exceeding 1 ns which begins with current pulse of the train. At higher fluences the interval increases and the plasma emission intensity behavior becomes smoother in time and goes on long after the train end. Recoil pressure behavior is affected with plasma formation which in the considered condition influences mainly on its slow (unmodulated) part which becomes as large as modulation pulses. However, this pressure grows is not due to intense ablation processes because in most cases τ_a between the trains remains sufficiently small. Relatively large value $\tau_a \sim 200$ ps (ablation depth $h_a \sim 400$ nm) is observed only at $E \sim 2E_{th}$.

REFERENCES

- [1] A.A. Samokhin, V.I. Vovchenko, N.N. Il'ichev, *Phys. Wave Phen.* 16(4), 275 (2008).
- [2] A.A. Samokhin, S.I. Kudryashov, A.E. Zubko, A.V. Sidorin, *Mathematica Montisnigri* 37, 76 (2016).
- [3] A.A. Samokhin, A.E. Zubko, *The 14-th International Conference on Laser Ablation, Book of abstracts COLA 2017*, 186 (2017).
- [4] A.A. Samokhin, E.V. Shashkov, N.S. Vorob'ev, A.E. Zubko, *JETP Letters* 108(6), 364 (2018).
- [5] A.A. Samokhin, E.V. Shashkov, N.S. Vorob'ev, A.E. Zubko, *Phys. Wave Phen.* 27(1), 42 (2019).

Section 3: Ultrafast laser nanofabrication and nanophotonics

Section Chair:

Sergey Kudryashov, e-mail: sikudr@lebedev.ru
(ITMO university; Lebedev Physical Institute, Russia)

Program committee:

George Tsibidis
(IESL, Greece)

Francois Corvoisier
(FEMTO-ST Institute, CNRS, France)

Fatih Omer Ilday
(Bilkent University, Turkey)

Alex Kuchmizhak
(Samara University, Russia)

Alexey Porfirev
(Far-Eastern Federal University, Russia)

Scope

Ultrafast nanostructured light + nanostructured matter

Ultrafast nanophotonics

Femtosecond-laser nanofabrication

Ultrafast dynamics at fs-laser-excited magnetic meta-surfaces

A. Alekhin^{1,2}, R. Bauer², P. Gaal² and V. Temnov¹

¹ Institut des Molecules et Materiaux du Mans, UMR CNRS 6283, Le Mans Universite, Le Mans, France;

² Center for Hybrid Nanostructures, University of Hamburg, Hamburg, Germany
e-mail: vasily.temnov@univ-lemans.fr

Interaction of femtosecond (fs) laser pulses with magnetic materials result in an immense variety of physical phenomena from different area of physics: nonlinear optics, ultrafast spintronics, acoustics, physics of shock waves and/or laser-induced phase transitions. From a metrological perspective, different time scales associated with those phenomena can be measured with fs temporal resolution in a variety of conventional linear and nonlinear optical pump-probe experiments. However, absorption of fs laser pulse by an opaque magnetic material may trigger different coherent and incoherent processes involving simultaneously electrons, phonons, and magnons, thereby rendering identification of the underlying mechanisms extremely challenging.

Complexity of the interpretation of ultrafast optical measurements can be reduced by the investigation of the experimentally accessible monochromatic excitations and their interactions: periodic oscillations of electromagnetic fields at the (fundamental, second harmonic, third harmonic etc.) optical frequencies, elastic deformations at MHz-THz frequencies and perturbations of the magnetic order like the ferromagnetic resonance (FMR) or exchange-coupled magnon modes oscillating at GHz-THz frequencies.

Monochromatic acoustic waves can be generated by fs laser excitation of periodic gratings, either in the so-called transient grating geometry [1-2] or using permanent gratings [3]. Characteristic feature in these experiments is the possibility to excite monochromatic surface acoustic waves (SAWs) with frequencies tunable by the grating periodicity up to a few tens of GHz in the case of sub-wavelength periodic structures (100 nm). Such subwavelength spatial periodicity represents the link between ultrafast magneto-acoustics and (magneto-)optics of meta-surfaces. Proper combination of the grating periodicity and the magnitude of an external magnetic field may fulfill the resonance conditions for the FMR frequency with SAWs and result in the resonant enhancement of the FMR precession [1-3], with the onset of parametric instabilities [2]. Whereas excitation of large-amplitude FMR precession through the laser-mediated resonant magneto-elastic interactions have not yet been optimized, such possibility would open a new avenue to modulate optical properties of magnetic meta-surfaces. Since static nonlinear magneto-optical and/or magneto-plasmonic effects are giant as compared to the linear ones [4-7], it is better to go beyond linear magneto-optical techniques and probe dynamics of the resonant magnetoacoustic interactions [1-3] using nonlinear magneto-optical detection schemes [4-7]. It can help to develop

real-life applications with magnetic meta-surfaces modulated on ultrafast time scales.

The work was financially supported by Strategie internationale "NNN-Telecom", ANRDFG "PPMI-NANO" (ANR-15-CE24-0032 and DFG SE2443/2), PRC CNRS-RFBR "Acousto-magneto-plasmonics", Deutsche Forschungsgemeinschaft (AL2143/3-1).

REFERENCES

- [1] J. Janusonis et al., Phys. Rev. B 94: 024415 (2016).
- [2] C. Chang et al., Phys. Rev. B 95: 060409 (2017).
- [3] C. Chang et al., Phys. Rev. Applied 10 : 034068 (2018).
- [4] I. Razdolski et al., ACS Photonics 3: 179 (2016).
- [5] V.V. Temnov et., J. of Optics 18, 0903002 (2016).

Laser-Induced Plasmas in Liquids

D. Amans¹, J. Lam², M. Diouf¹, A. Chemin¹, G. Ledoux¹, V. Motto-Ros¹,
C. Dujardin¹

¹Univ Lyon, Univ Claude Bernard Lyon 1, CNRS, Institut Lumière Matière, Villeurbanne, France.

²Center for Nonlinear Phenomena and Complex Systems, Université Libre de Bruxelles, Boulevard du Triomphe, 1050 Brussels, Belgium.

e-mail: david.amans@univ-lyon1.fr

Laser-induced plasmas in liquids display particular thermodynamics conditions as they are characterized by a high electron density and low temperatures. The growing interest in their study stems from the need to reach a better control and a better reproducibility over at least two experimental methods: (i) Laser-Induced Breakdown Spectroscopy (LIBS), an analytical method which deserves being applied underwater, and (ii) laser generation of nanoparticles in liquids which is a versatile method to easily produce stable colloids.

Laser-generated plasmas in liquids are highly transient and exhibit a fast cooling because of the plasma-liquid interaction. On the one hand, the fast cooling helps to nucleate and stabilize nanoparticles with metastable crystal structure. On the other hand, the low temperatures tend to avoid emission from ions and species with high-energy excited states. Therefore, only emissions from diatomic molecules and neutral atomic species are observed underwater. In this context, assessing the condition of local thermodynamic equilibrium (LTE) requires criteria associated with the molecular degrees of freedom, i.e. rotations and vibrations [1]. Indeed, the commonly employed criteria for LTE (such as the McWhirter criterion) have not been defined to address internal molecular degrees of freedom.

In the framework of laser-generated nanoparticles in liquids, we will present our work on underwater plasma [2-3], as well as its interest to address the nucleation of nanoparticles [4].

REFERENCES

- [1] J. Lam, V. Motto-Ros, D. Misiak, C. Dujardin, G. Ledoux, D. Amans, *Spectrochimica Acta Part B*, 101, 86–92 (2014).
- [2] J. Lam et al. *Phys. Chem. Chem. Phys.*, 16, 963–973 (2014).
- [3] D. Amans, M. Diouf, J. Lam, G. Ledoux, C. Dujardin, *J. Colloid Interface Sci.*, 489, 114–125 (2017).
- [4] J. Lam, D. Amans, C. Dujardin, G. Ledoux, A.-R. Allouche, *J. Phys. Chem. A*, 119, 8944–8949 (2015).

Formation mechanisms and applications of magnetic-plasmonic alloy nanoparticles obtained by laser ablation in liquid

V. Torresan¹, A. Guadagnini¹, M. Fernandez Van Raap², V. Amendola¹

¹ Department of Chemical Sciences, University of Padova, via Marzolo 1, I-35131 Padova, Italy;

² Instituto de Física La Plata IFLP-CONICET, Departamento de Física, Universidad Nacional de La Plata, La Plata, Buenos Aires, Argentina;

e-mail: vincenzo.amendola@unipd.it

Laser ablation in liquid (LAL) emerged as a powerful technique for the synthesis of multielement nanoparticles (NPs) such as metal alloys with thermodynamically forbidden composition.[1] Consequently, there is a great interest in expanding the current knowledge about NPs formation during LAL, in order to improve the control on product structure and to extend the range of compositions accessible by this technique. Here we discuss about the results obtained so far with laser ablation synthesis in solution of nanoalloys with magnetic and plasmonic properties and metastable phase. In particular, we show how the systematic investigation carried out by laser ablation of thin metallic films by changing target structure, liquid environment and pulse length provided useful insight about the formation mechanism of homogeneous nanoalloys and about how to switch from homogeneous to core-shell nanoparticles. It will be also shown how these results are of interest for the general understanding of the processes behind the LAL technique[2,3] and for the production of multifunctional nanomaterials which are appealing in a wide range of applications from catalysis[4] to photonics[5] and nanomedicine[6].

REFERENCES

- [1] V. Amendola, Phys. Chem. Chem. Phys., 15, 3027-3046 (2013).
- [2] S. Scaramuzza, S. Agnoli, V. Amendola, Phys. Chem. Chem. Phys., 17, 28076-28087 (2015).
- [3] V. Amendola, S. Scaramuzza, E. Cattaruzza; J.Coll.Interf.Sci., 489, 18-27 (2017).
- [4] I. Vassalini, L. Borgese, M. Mariz, S. Polizzi, G. Aquilanti, P. Ghigna, A. Sartorel, V. Amendola, I. Alessandri, Angew.Chem. Int.Ed. 56, 6589-6593 (2017)
- [5] V. Amendola, S. Scaramuzza, S. Agnoli, S. Polizzi, Nanoscale, 6, 1423-1433 (2014).
- [6] V. Amendola, S. Scaramuzza, L. Litti, G. Zuccolotto, A. Rosato, E. Nicolato, P. Marzola, G. Fracasso, C. Anselmi, M. Pinto, M. Colombatti, Small, 10, 2476-2486 (2014).

Numerical simulation of metal-semiconductor and metal-oxide nanoparticles for sensors

N. Busleev¹, S. Kudryashov¹, I. Saraeva¹, A. Ivanova¹, A. Drakin¹, D.Zayarny¹
and A. Ionin¹

¹Lebedev Physical Institute, 53 Leninsky Prospect, Moscow, 119991, Russian Federation;
e-mail: busleevni@lebedev.ru

Quick and efficient sensing of low concentration of analyte remains a pressing issue for biochemical and medical applications [1]. Plasmonic biosensors are durable, rapid and sensitive. Aside from size and geometry, the material of plasmonic nanoparticles represents another parameter that allows fine-tuning of excitation [2]. Nanosecond laser pulses were used for ablation of semiconductor target submerged in metallic salt. In result of this process, particles with complex composition were obtained. Optical parameters of such particles were investigated by numerical methods. Effect of elements proportion adjustment on the particle electromagnetic response was evaluated. Plasmon features and their possible applications to sensors and plasmon-enhanced luminescence were characterized.

REFERENCES

- [1] J. Langer, S. Novikov, L. Liz-Marzán *Nanotechnology* Vol 36 Number 32 (2015).
- [2] J. Xavier, S. Vincent, F. Meder, F. Vollmer *Nanophotonics* Vol 7 Issue 1 (2018).

Femtosecond laser 3D micromachining: from research prototype to industrial tool

Y. Cheng^{1,2,3}

¹ State Key Laboratory of High Field Laser Physics, Shanghai Institute of Optics and Fine Mechanics, Chinese Academy of Sciences, Shanghai 201800, China;

² State Key Laboratory of Precision Spectroscopy, East China Normal University, Shanghai 200062, China;

³ XXL-The Extreme Optoelectromechanics Laboratory, School of Physics and Materials Science, East China Normal University, Shanghai 200062, China;
e-mail: ya.cheng@siom.ac.cn

We present two examples of the recent developments on the femtosecond laser microfabrication of macro-scale products for chemical and photonic applications. First, we demonstrate fabrication of macro-scale 3D glass objects of large heights up to ~ 3.8 cm with a well-balanced (i.e., lateral vs longitudinal) spatial resolution of ~ 20 μm using femtosecond laser induced chemical etching (FLICE) [1]. The remarkable accomplishment is achieved by revealing an unexplored regime in the interaction of ultrafast laser pulses with fused silica which results in aberration-free focusing of the laser pulses deeply inside fused silica. Second, femtosecond laser micromachining has also inspired the recent breakthroughs in the field of photonic integrated circuits (PICs) for generating high-quality photonic structures on lithium niobate (LN) on insulator (LNOI) [2]. This is enabled by the development of chemo-mechanical polish lithography (CMPL), which holds the promise for realizing LNOI waveguides of ultralow propagation loss approaching the absorption limit of LN. We demonstrate fabrication of low loss optical waveguides with the CMPL and construction of beamsplitters with the fabricated LNOI waveguides. The progresses made towards the large-scale high-quality rapid manufacturing will promote applications of femtosecond laser micromachining from a research prototype to an industrial tool, benefitting various fields including pharmacy, fine chemistry, bioengineering and optical communication.

REFERENCES

- [1] P. Wang, W. Chu, W. Li, et al., arXiv preprint, arXiv:1904.04027 (2019).
- [2] M. Wang, R. Wu, J. Lin, et al., Quantum Engineering (1), e9 (2019).

Modelisation of dielectric material structuration by femtosecond laser pulses

B. Chimier¹, R. Beuton¹, P. González de Alaiza Martínez¹, R. Nuter¹,
P. Quinoman¹ and G. Duchateau¹

¹Univerty of Bordeaux-CNRS-CEA, CELIA, Talence, France
e-mail: benoit.chimier@u-bordeaux.fr

Femtosecond laser pulses are a versatile tool for processing of dielectric materials for industrial applications. With such laser pulse, the laser energy absorption is highly nonlinear and includes effects like multiphoton absorption and plasma generation. These properties, associated to beam shaping, provide a controlled way to induce modifications in transparent materials.

In CELIA, we have developed the ARCTIC code solving the Maxwell equations coupled to equations describing the nonlinear response of the matter. Specific laser boundary conditions have been developed to consider different kinds of laser pulses, in particular tightly focused or bessel beams [1]. Numerical simulations have been performed to understand the main physical processes, and their coupling, which occur during the propagation of such kinds of femtosecond laser pulse in dielectric materials. The energy deposition calculated with the ARCTIC code, have been introduced as an initial condition for a second numerical code describing the thermo-elasto-plastic and hydrodynamic responses of the irradiated material, to determine the permanent modifications induced by the laser [2,3].

REFERENCES

- [1] P. González de Alaiza Martínez, G. Duchateau, B. Chimier, R. Nuter, I. Thiele, S. Skupin, V.T. Tikhonchuk, *Phys. Rev. A*, 98, 043849 (2018).
- [2] R. Beuton, B. Chimier, J. Breil, D. Hebert, P.-H. Maire, G. Duchateau, *J. Appl. Phys.*, 122, 203104 (2017).
- [3] R. Beuton, B. Chimier, J. Breil, D. Hebert, K. Mishchik, J. Lopez, P.-H. Maire, G. Duchateau, *Appl. Phys. A*, 124, 324 (2018).

Imaging and modeling the multipulse dynamics of ultrafast laser-induced self-organization

J. P. Colombier¹, A. Rudenko¹, A. Abou-Saleh¹, L. Douillard², F. Pigeon¹,
F. Garrelie¹

¹Univ Lyon, UJM-Saint-Etienne, CNRS, Laboratoire Hubert Curien UMR CNRS 5516, F-42023 St-Etienne, France

²CEA IRAMIS SPEC Service de Physique de l'Etat Condensé, UMR CNRS 3680, Université Paris Saclay F-91191 Gif sur Yvette, France

e-mail: jean.philippe.colombier@univ-st-etienne.fr

To form regular periodic patterns on surface irradiated by ultrafast laser with a nanoscale control, the understanding of the light coupling process is the most promising strategy. Ultrafast optical scattering by surface is governed by the local nanoroughness and the mutual response of the nanostructures through both radiative and non-radiative fields interaction. The spontaneous ordering occurs as a fingerprint of coherent light, potentially involving surface plasmonic effects and optical resonances but also modulated heat confinement and hydrodynamic movements [1-2]. Upon multi-pulse laser irradiation, feedback mechanisms regulate the surface self-patterning, feeding the debate regarding the exact nature of the involved surface waves. In particular, a periodicity shift is reported with the increase of the applied pulses, interrogating on the light distribution evolution with the transiently growing surface relief. The progressively formed nano-topography influences strongly the local energy deposition up to achieve a spatial pattern stability in terms of periodicity and depth for all metals. To identify the nature of this intriguing self-regulation process, an imaging approach with a spatial nm resolution coupled with a self-consistent theoretical study are proposed.

Laser-induced periodic surface structures were realized on Ti samples and photoemission electron microscopy was employed for imaging the ultrafast laser light distribution on the pre-structured surface. Periodical distributions of light were progressively observed with a frequency shift as the number of applied pulses increases. Concentrated hot-spot patterns were revealed to be superposed to this expected periodic absorption, with the demonstration that nanostructures periodicity reducing is driven by the concentration of the local-field enhancement centers. The roles of collective effects and inter-pulse feedback on the resulting surface topographies are then elucidated by a 3D numerical approach combining electromagnetism and hydrodynamics to simulate the multipulse dynamics. Complex surface topography is driven by the regulation that originates from the constructive and destructive roles of the electromagnetic and hydrodynamic processes. Also, the role of dipole-dipole nanohole intercoupling is originally proposed to interpret the period decrease [3]. This nanoscale imaging coupled with dynamics calculations unravelling the intricate role of light absorption and

nanostructure growth, opening new ways towards efficient fabrication of surface periodic nanostructures.

REFERENCES

- [1] A. Rudenko, J.P. Colombier, S.Höhm, A. Rosenfeld, J Krüger, J. Bonse, and T. Itina, *Scientific Reports* 7, 12306 (2017).
- [2] X. Sedao, A. Abou Saleh, A. Rudenko, T. Douillard, C. Esnouf, S. Reynaud, C. Maurice, F. Pigeon, F. Garrelie, and J.P. Colombier, *ACS photonics* 5, pp. 1418 (2018).
- [3] A. Rudenko, C. Mauclair, F. Garrelie, R. Stoian, and J.P. Colombier, *Nanophotonics* 8, pp. 459, (2019).

High intensity ultrafast Bessel beam shaping

F. Courvoisier, R. Meyer, J. Hoyo, L. Froehly and R. Giust

Institut FEMTO-ST, Université Bourgogne Franche-Comté, 15B Avenue des Montboucons, 25030 Besançon cedex, France;

e-mail: francois.courvoisier@femto-st.fr

Transparent dielectrics, particularly glass, are becoming ubiquitous in technology. They are used in a large number of applications belonging to different fields such as electronics, consumer electronics, automotive or lighting. However, most of the applications require deep drilling which is very demanding for conventional lithography techniques. Ultrafast infrared laser pulses are ideal to process glass and sapphire because nonlinear ionization allows for depositing laser energy straightforwardly within the bulk of the material. In this context, Bessel beams provide novel opportunities for laser processing with high aspect ratio.

Bessel beams are generated by an interference of an infinite set of plane waves distributed along the generatrix of a cone [1]. When the cone angle is sufficiently high, the propagation of intense ultrafast Bessel beams can be stationary [2]. In this case, a single laser pulse creates a high density plasma along a nanometric cylinder with high aspect ratio. The plasma relaxation creates a microexplosion opening a void even within the bulk of hard material such as sapphire [3,4].

We will review recent results concerning the development of high aspect ratio Bessel beam shaping with high quality. We have demonstrated Bessel beams with very large focusing angle, up to 35° and high quality [5]. These beams, used in combination with a femtosecond laser source, allowed the drilling in single shot of vias with 100 nm diameter in glass, opening novel perspectives for nanofluidics applications. A second key advance is the increase of the Bessel beam length up to several millimeters while preserving the high focussing angle and avoiding optical damage in the shaping optics [6]. We designed a novel beam shaper capable of handling very high energies, at the Joule level and demonstrated applications to single-pass stealth dicing of glass for thickness up to 1 cm.

REFERENCES

- [1] J. Durnin et al., Phys. Rev. Lett., 58, 1499-1501 (1987).
- [2] P. Polesana et al., Phys. Rev. A, 77, 043814 (2008).
- [3] M. K. Bhuyan et al., Appl. Phys. Lett., 97, 081102 (2010).
- [4] L. Rapp et al., Scientific Reports, 6, 34286 (2016).
- [5] P. Boucher et al., Appl. Opt., 57, 6725 (2018).
- [6] R. Meyer et al., Appl. Phys. Lett., in print (2019).

Femtosecond laser fabrication of plasmon resonance micro- and nanostructures for surface-enhanced spectroscopy

P. A. Danilov¹, A. A. Ionin¹, S. I. Kudryashov¹, A. A. Kuchmizhak^{2,3},
S. N. Khonina⁴, A. P. Porfirev^{4,5} and A. A. Rudenko¹

¹ P.N. Lebedev Physical Institute of RAS, Moscow Russia;

² School of Natural Sciences, Far Eastern Federal University, Vladivostok, Russia;

³ Institute for Automation and Control Processes FEB RAS, Vladivostok, Russia;

⁴ Image Processing Systems Institute of the RAS-Branch of FSRC “Crystallography&Photonics“ of the RAS, Samara, Russia;

⁵ National Research University, Samara, Russia

e-mail: pavel-danilov2009@yandex.ru

Recently, simple, single-step mask-less micro-patterning of thin plasmonic films by tightly-focused femtosecond laser pulses was demonstrated as the enabling technology for fabrication of single nanophotonic elements and laboratory-scale micro-hole array sensors for robust and high-sensitivity, label- and luminescence-free surface-enhanced IR-spectroscopy (SEIRS) in chemo- and biosensing applications [1], based on extraordinary transmission (EOT) of electromagnetic radiation[2,3]. The different optical devices (for example, diffractive optical elements – DOE), which generate complex intensity distribution of laser beam, provides fabrication of plasmonic structures unusual forms. A key concept underlying the functionalities of many metasurface approaches is their use of constituent elements with spatially varying optical properties.

In this work, we report on advanced high-throughput micro-patterning of thin plasmonic films (Ag, Au, Cu) by DOE-modulated tightly-focused femtosecond laser pulses for fabrication of laboratory-scale arrays for surface-enhanced IR-spectroscopy. Their SEIR-chemosensing modalities were tested regarding a model analyte Rhodamine 6G.

REFERENCES

[1] F. Neubrech, C. Huck, K. Weber, A. Pucci and H.Giessen, *Chemical reviews*,117(7), 5110-5145 (2017).

[2] A. Hartstein, J.R. Kirtley and J.C. Tsang, *Physical Review Letters*, 45(3), 201 (1980)

[3] P.A. Danilov, S.A. Gonchukov, A.A. Ionin, R.A. Khmel'nitskii, S.I. Kudryashov, T.T. Nguyen and D.A. Zayarny, *Laser Physics Letters*, 13(5), 055602 (2016).

Linear and nonlinear ultrafast optical response of a single nano-object

N. Del Fatti, A. Crut, P. Maioli and F. Vallee

FemtoNanoOptics Group ILM, CNRS - Université Lyon 1, Bat. Kastler, 43 Bd. du 11 novembre, 69100 Villeurbanne, France
e-mail: fabrice.vallee@univ-lyon1.fr

The large size dependence of the optical response of nano-objects has led to considerable fundamental and technological interests in the academic and industrial domains. In particular, it has been extensively exploited to design new optical materials or to create nanosensors, opening the fields of nanophotonics and plasmonics. Because of the very weak optical response of a single object, most investigations have been performed simultaneously probing a large number of objects, typically 10^4 to 10^6 in the studied volume. Due to the unavoidable particle to particle fluctuations of the geometry and environment, only a mean response is obtained, masking the details of the individual particle response and limiting applications and comparison with theoretical models.

These limitations can be overcome by investigating a single particle, which requires development of very high sensitivity optical detection schemes. After briefly recalling the principles of the methods permitting to detect direct light interaction with a single particle, i.e., light scattering and absorption, we will focus on a far-field optical technique, the spatial modulation spectroscopy [1]. This method permits quantitative measurements of the extinction cross-section of a single particle and precise comparison with theoretical models when its morphology is independently determined, for instance, by electron microscopy or AFM. Optical detection and spectroscopy of single metal nanoparticles and carbon nanotubes by spatial modulation spectroscopy will be discussed, focusing on the impact of the object morphology and environment on its optical response. Its extension to quantitative analysis of the ultrafast nonlinear response of a single particle will also be presented.

REFERENCES

- [1] A. Crut, P. Maioli, N. Del Fatti, and F. Vallée, *Chem. Soc. Rev.* **43**, 3921 (2014)

Combination of nanosecond laser texturing and functional nanoengineering for the design of polyfunctional superhydrophobic coatings

K. A. Emelyanenko¹, A. M. Emelyanenko¹ and L. B. Boinovich¹

¹ A.N. Frumkin Institute of Physical Chemistry and Electrochemistry, Russian Academy of Sciences (IPCE RAS), Moscow, Russia;
e-mail: emelyanenko.kirill@gmail.com

Industrial application of coatings designed to functionalize surfaces of metallic materials, in particular to impart superhydrophobic properties, often stumbles upon low corrosion resistance of such coatings, erosion under abrasive loads, damage due to thermal shock stresses or impact of low temperature and so on. Thus, in order to provide industrial applicability, it is necessary to fabricate polyfunctional coatings stable under various conditions rather than maximize one functional property. In this study, using the aluminum-magnesium and stainless steel alloys as examples of widely spread metallic materials, we show that a combination of functional nanoengineering and nanosecond laser texturing with the appropriate treatment regimes can be successfully used to transform a metal into a superhydrophobic material with exceptional mechanical and chemical properties. Capability of pulsed laser treatment for directional modification of the surfaces relies on the ability to simultaneously control morphology through variation of texturing pattern, phase structure and grain size through tuning of melting-solidification processes and chemical composition via alteration of atmosphere composition during laser processing.

The combination of superhydrophobic state, nano- and micro features of the hierarchical surface, and the appropriate composition and phase structure of the surface textured layer allowed us to provide the surface with the outstanding level of resistance of superhydrophobic coatings to external chemical and mechanical impacts [1]. In particular, experimental data presented in this study indicate high resistance of the fabricated coatings to sand abrasive wear, pitting corrosion, superheated water vapor, and rapid temperature cycling from liquid nitrogen to room temperatures [1, 2], as well as combination of destructive loads during prolonged operation in atmospheric conditions [3] without notable degradation of superhydrophobic performance.

REFERENCES

- [1] L.B. Boinovich et al., ACS Nano 11(10), 10113-10123 (2017)
- [2] L.B. Boinovich et al., Langmuir 34(24), 7059-7066 (2018)
- [3] L.B. Boinovich et al., ACS Nano 13(4), 4335-4346 (2019)

Methods of femtosecond spectroscopy of nanocomposites

O. M. Fedotova^{1,2}, O. Kh. Khasanov¹, G. A. Rusetskii¹, V. G. Nikiforov³ and V. V. Samartsev³

¹ Scientific-Practical Material Research Centre NAS Belarus, Minsk, Belarus;

² Belarusian State University, Minsk, Belarus;

³ Kazan E. K. Zavoisky Physical-Technical Institute of the KSC RAS, Kazan, Russia ;
e-mail: olyushkaf@yahoo.com

Methods of femtosecond time resolved spectroscopy of nanocomposites are elaborated. Features of photon echo (PE) and time resolved four-wave mixing (TRFWM) signals in nanocomposites consisted of semiconductor quantum dots (QD) incorporated into nonlinear dielectric matrix are studied. In particular, impacts of value and angular distribution of permanent dipole moments (PDM) as well as their spatial dispersion on two pulse responses are under investigation.

Large PDM values are inherent to many semiconductor QDs, including ZnO QDs, cellulose nanocrystals [1] etc. Bearing in mind large potential of quantum dot nanostructures for applications this work is aimed to reveal PDM impact on the TRFWM as well as PE signals.

For simplicity, we consider three-level system, which is in resonance with pump pulses at the lowest transition between the QD exciton states. Due to the PDM interaction with the light pulses the Hamiltonian of the light-matter interaction contains fast oscillating diagonal elements that makes impossible traditional theoretical technique application to calculate responses of medium on pulse excitation. After unitary transformation, we arrive at Hamiltonian describing QD interaction with a number of fields at multiple frequencies. Applying successively a number of unitary transformations, we obtain Hamiltonian for generalized two-level system in rotating reference framework. This Hamiltonian does not contain fast oscillating terms and describes one- and two-quantum transitions. Elaborated approach allows us to deduce the Bloch equations for the QD with PDM in slowly varying envelope approximation and to solve them by means of well-known computational procedures.

As analysis shows, besides resonant component macroscopic photoinduced polarization contains multiple harmonics, which can be sources of responses at corresponding frequencies in the nanostructure. We have calculated PE signals under noncollinear two pulse excitation taking into account excitation induced shift of absorption frequency, the QD spatial dispersion and angular distribution of PDMs relatively electric field of excitation pulses. In addition to signals at resonant frequency under well-known spatial synchronism conditions, we predict observation of responses on two-pulse excitation of nanocomposite at multiple frequencies. The spatial synchronism conditions of new responses will differ from those for the primary photon echo signal. The signals at multiple frequencies

and terahertz responses are originated from the PDM interaction with excitation pulses and drastically depend on its angular distribution. The most intensive signals among all responses will be at double and terahertz frequencies. Local field effect such as an excitation induced shift parametrically generates different echo signals at resonant frequency with corresponding spatial matching conditions. The larger order of PE signal the less its intensity. Spatial dispersion of dipole moments in QD nanostructure influences only on even responses.

Conclusions concerning the TRFWM signals coincide with the PE responses, but for short time delay between excitation pulses the non-resonant nonlinear matrix will contribute to the TRFWM signals mainly to resonant, second and terahertz harmonics.

REFERENCES

- [1]. B. Frka-Petesic B Jean, L Heux EPL, 107, 28006 (2014)

Effect of gas composition during pulsed laser deposition of silicon nanocrystals on their structure and photoluminescent properties

A. A. Fronya^{1,2}, S. V. Antonenko¹, S. I. Derzhavin^{1,4}, S. M. Klimentov^{1,4},
V. Yu. Timoshenko^{1,2,3}

¹ National Research Nuclear University “MEPhI”, Moscow, Russia;

² P.N. Lebedev Physical Institute, Moscow, Russia;

³ M.V.Lomonosov Moscow State University, Faculty of Physics, Moscow, Russia;

⁴ A.M.Prokhorov General Physics Institute, Moscow, Russia;

e-mail: nastya708@yandex.ru

Recently, silicon-based nanocrystalline materials are extensively studied because of their potential biomedical applications [1-3]. A method of the pulsed laser ablation, which represent a version of the pulsed laser deposition (PLD), makes it possible to obtain particles with sizes ranging from ten to several hundred nanometers [3]. The size and physical properties of the obtained particles are largely dependent on the conditions of their formation, i.e. laser pulse duration and power [1]. In the present work we report on an effect of the gas composition during PLD process on the structure and photoluminescent properties of silicon (Si) nanocrystals (NCs). Samples of Si-NCs were prepared by PLD under excimer laser irradiation of crystalline silicon (c-Si) targets in a mixture of helium (He) and nitrogen (N₂) with different partial pressures. The obtained samples were experimentally investigated by means of the scanning electron microscopy, Raman scattering and photoluminescence (PL) spectroscopy. Sizes of Si-NCs were found to decrease when the N₂ partial pressures increases. The PL spectra of the samples prepared at larger N₂ pressures exhibit a shift of the maximum in shorter wavelength region. The PL properties are explained by possible contributions of the quantum confinement effect and electronic states related to silicon nitride. The obtained results indicate the possibility to control both the structure and optical properties of Si-NCs by changing the active gas composition during PLD.

The work was supported in the frame of the state project No.16.2969.2017/4.6.

REFERENCES

- [1] A.A. Ishchenko, G.V. Fetisov, L.A. Aslanov, CRC Press, 2014.
- [2] K.P. Tamarov, L.A. Osminkina, S.V. Zinovyev et al., Sci. Rep. 4, 7034 (2014).
- [3] A.V. Kabashin, V.Yu. Timoshenko, Nanomedicine, 11 (17), 2247 (2016).

Laser induced periodical surface structures produced by fs pulses on nano layer thin films

B. Gaković¹, S. Petrović¹, D. Peruško¹, E. Skoulas², E. Stratakis²

¹ Vinča Institute of Nuclear Sciences, University of Belgrade, Belgrade, Serbia;

¹ Institute of Electronic Structure and Laser (IESL), Foundation for Research and Technology (FORTH), Crete, Greece;

e-mail: biljagak@vin.bg.ac.rs

Laser induced periodical surface structures (LIPSS), formed by ultra short laser pulses, are known and examined for years, but still there is need for studying their formation on different materials with different laser systems. Nano scale multi layer thin films (MLTF), a new kind of nano materials, are attractive due to their better or new properties comparing to the material of the same bulk components. In this research, a different combination of metallic nano layers (Ni/Ti, Cr/Ti, Zr/Ti) was deposited on silicon substrate by ion sputtering. The MLTF surface was mirror like, with roughness below 10 nm. The thin films were irradiated in air by 170 fs laser pulse duration. The laser wavelength was 1026 nm. The laser beam was linearly polarized and almost perpendicular to the sample surface. The LIPSS were produced by different scanning speeds and two sample orientations - polarization either parallel or perpendicular to the laser beam scanning direction. After irradiation, the detailed examination of obtained surface modifications was done (Figs. 1. a and b).

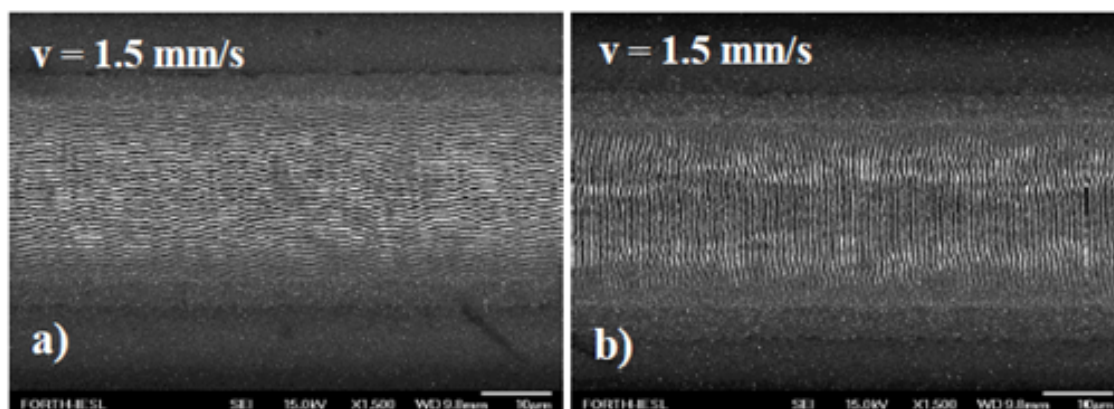

Figure 1: LIPSS formation on the Cr/Ti nano layer by 170 fs laser beam using the same scanning speed but different polarization. Polarization was parallel to the laser beam scanning direction a) and perpendicular b).

Formation of periodic surface structures, on all investigated MLTF, were registered, despite that the table values of dielectric constants for Cr, Zr and Ti suggest the absence of surface plasmons, a wave necessary for forming periodic structures on metals [1,2]. We found that the structure periods formed on MLTF were to some extent less than the laser wavelength. We believe that the dielectric constants of all MLTF changed significantly due to intense laser pulse heating

and surface structuring and roughening at nano meter scales, permitting surface plasmon excitation and periodic structure formation.

REFERENCES

- 1] E.V. Golosov, A.A. Ionin, Yu.R. Kolobov, S.I. Kudryashov, A.E. Ligachev, Yu.N. Novoselov, L.V. Seleznev, and D.V. Sinitsyn, *J. Exp. Theor. Phys.*, 113 (2011) pp. 14-26.
- [2] Hai-Ying Song, Shi-Bing Liu, H.Y. Liu, Yang Wang, Tao Chen, and Xiang-Ming Dong, *Opt. Express*, 24 (2016) pp. 012151-12165.

IR femtosecond-laser ablation and processing of solid target by self-induced feedback guided second harmonic generation.

A. A. Garmatina^{1,2}, F. V. Potemkin¹, E. A. Migal¹ and V. M. Gordienko¹

¹ Faculty of Physics and International Laser Centre M.V. Lomonosov Moscow State University, Moscow 119992, Russia

² National Research Centre "Kurchatov Institute", Moscow 123182, Russia
e-mail: alga009@mail.ru

Micro processing of materials by femtosecond laser pulses is promising for employ in microsurgery and technology tasks. Using laser pulses for plasma assisted ablation can provide an optical feedback signals such as second harmonic of laser radiation. Second harmonic (SH) of laser radiation generated in laser plasma of the target is nonlinearly depends on laser intensity and can be utilize as effective tool for controlling the process of materials micromachining not only by measuring integrated signal but also registering the spectrum. However, SH signal usually registered simultaneously with emission spectrum, which is recorded in the SHG region [1].

In mid-IR region (in the vicinity of 2 μm), the background emission spectrum has a relatively smaller amplitude. Due to this reason, using mid-IR radiation can be useful to enhance the ratio of SH signal respect to the accompanied emission spectrum.

The purpose of this work is to demonstrate for the first time the possibility of employing the second harmonic of mid-IR femtosecond radiation generated in laser plasma as a diagnostic channel and feedback signal in the regime of controlled micromachining of a solid target and to find conditions when SH is registered with maximal S/N ratio to emission signal using fs laser pulses with a wavelength of $\sim 1.6 \mu\text{m}$.

In the experiments, tightly focused ($f = 5 \text{ cm}$) femtosecond IR laser radiation from optical parametric amplifier pumped by Cr:F laser ($\lambda = 1.66 \mu\text{m}$, $\tau = 170 \text{ fs}$, $I \sim 10^{13} \text{ W/cm}^2$) interacted with a solid target (Cu foil, thickness of 20 μm and 40 μm), which placed at the angle of 30 degree to the direction of propagation of laser radiation. The proposed scheme allowed spatially separate the SH signal and the emission signal.

We found that SH from the plasma was recorded at a wavelength of 836 nm and was shifted by 6 nm into the red region in both the first pulse and from the channel 40 microns deep. It was established that under creating a microchannel in conditions of reaching a depth equal to the length of the beam waist of the focusing lens, the amplitude of the SH signal goes to a quasistationary level (fig.1). The subsequent deepening of the focus on the length of the waist is accompanied by an increase in the SH signal to the values recorded in the first pulse.

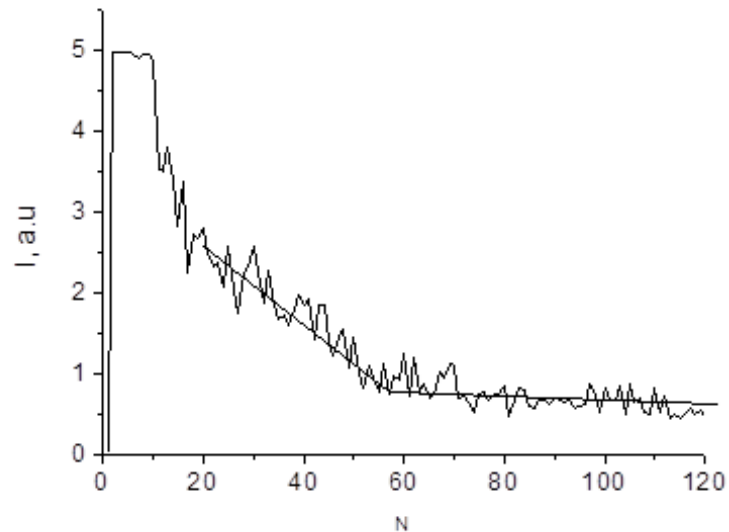

Figure 1: Dependence of SH signal from Cu foil (thickness 80 μm) on laser pulse number n at pulse energy 80 μJ and intensity of $I \sim 10^{13}\text{W}/\text{cm}^2$.

We also discuss the results of experimental data in the second-harmonic registration scheme in the direction opposite to the laser radiation.

This work was supported by the Russian Science Foundation (Project No. 17-72-20130)

REFERENCES

- [1] I. A. Zhvaniya, A. A. Garmatina, I. A. Makarov, V. M. Gordienko, *J. of Appl. Phys.* 120, 045901 (2016)

Photoluminescence and nonlinear-optical effects in CdSe quantum dots in liquid-crystal polymer matrix

L. A. Golovan¹, A. V. Elopov¹, V. B. Zaytsev¹, S. V. Zobotnov¹,
A. A. Ezhov^{1,2}, D. M. Zhigunov³, O. N. Karpov², G. A. Shandryuk²,
A. S. Merekalov²

¹ Faculty of Physics, M. V. Lomonosov Moscow State University, Moscow, Russia;

² A. V. Topchiev Institute of Petrochemical Synthesis RAS, Moscow, Russia;

³Skolkovo Institute of Science & Technology, Moscow, Russia

e-mail: golovan@physics.msu.ru

Semiconductor quantum dots (QD) and nanocomposites based on them attract a great deal of interest as media to generate and control laser radiation. In particular, this can be done with the help of polymer-QD nanocomposite. Employment of liquid-crystal polymers (LCP) is very promising since they allow formation of ordered QD arrays and high QD concentration. Measurement of QD-LCP nanocomposite photoluminescence (PL) spectra and PL kinetics is the first stage of study of such nanocomposites. It would be also very instructive to compare results obtained both for LCP and amorphous polymer matrices and study possible nonlinear-optical effects. We employed CdSe and core/shell CdSe/ZnS QD embedded into smectic BA-6PA and amorphous PMBA-6A polymers with various QD mass fractions (up to 60%). QD diameter was 4.1 nm.

PL was excited by picosecond laser pulses at 532 nm. The PL spectra contain two bands (2.15 and 1.70 eV) corresponding to exciton radiative recombination and radiative recombination in defects (traps) at QD-matrix interface, the latter band intensity increases for CdSe in LCP matrix in comparison with amorphous one and practically disappear in CdSe/ZnS QD nanocomposites. Increase of QD concentration results in PL lifetime decrease for QDs in LCP matrices. Comparison of LCP and amorphous matrix QD nanocomposites evidences faster PL decay and less quantum yield in the latter case. Core/shell QDs exhibit more effective PL and weaker effect of the matrix than CdSe QDs.

Employing femtosecond laser pulses (1250 nm, 80 fs, 80 MHz) allowed us to detect the second-harmonic (SH) and up-converted signals. The latter spectrum coincides with one excited at 532 nm. The up-conversion could be considered as an anti-Stokes PL in the QDs excited by the SH.

In conclusion, PL and up-conversion measurements of CdSe and CdSe/ZnS QDs embedded in the polymer matrices indicate potential use of the LCP for formation of QD nanocomposites allowing effective light generation.

This work was supported by RFBR grant 18-02-00548, synthesis of QDs and polymer matrices was carried out within the State Program of TIPS RAS.

Simulation of Possible Scenarios of the development of Laser Induce Periodic Surface Structures (LIPSS) with COMSOL and the Molecular Dynamic Code LAMMPS.

W. Husinsky

Institut für Angewandte Physik, Technische Universität Wien, Wiedner Hauptstrasse 8-10, Austria
e-mail: husinsky@iap.tuwien.ac.at

Irradiation of various surface materials by ultra-short laser radiation, typically with pulse widths of 10-300fs, results in the development of Laser-induced self-organized periodic surface structures (ripples). The periodicity of these structures ranges from the wavelength λ of the laser to well below λ . Structures down to a few tens of nm can be observed. However, the existence and form of the LIPSS critically depends on the intensity, fluence, wavelength and pulse width of the laser light as well as on the number of laser pulses and, not to forget, the material properties [1].

The development of the LIPSS structure can be regarded as a complex interplay between the electric field on the surfaces (including surface plasmon-polaritons) [2] and the ultra-short-laser-ablation dynamics [3]. Since the formation of LIPSS in most cases requires multiple laser pulses, the surface topography and hence the electric field distribution will change from shot to shot. Only the resulting feedback ensures the development of the LIPSS. The simulation realized here follows a procedure proposed by [4].

In order to manage a physically reasonable sample size of 500nm to 1 μ m (x and y -dimension) and 200nm in the z direction, with a resolution of below 10nm (which is required for simulating experimentally observed LIPSS with 10 nm and larger frequencies), the simulation was implemented on a HPC Cluster (VSC3-Vienna Scientific Cluster) and consists of several steps, which are executed in a loop for a certain number of laser pulses: 1.) Creating a sample with rough surface in LAMMPS [5]; 2.) Extracting the surface for input into COMSOL; 3.) Simulation of the electric field distribution on the surface and in the sample with COMSOL (Wave Optics Module, Data Input and Output handled via Application Builder in the batch script). 4.) Conversion of the calculated field distribution into possible energy scenarios leading to ablation (particle ejection) 5.) MD simulation on the atomic scale taking into account the results from step 4 to obtain the new sample (surface) morphology. 6.) Repeat from step 2.

REFERENCES

- [1] Nathala, C.S.R. et al., Optics Express, 2015. 23(5): p. 5915-5929.
- [2] Kudryashov, S.I. et al., Optics Letters, 2015. 40(21): p. 4967-4970.
- [3] H.Dachraoui, W. Husinsky, Applied Physics Letters, 2006. 89(10): p. 4102.
- [4] Skolski, J.Z.P. et al., Journal of Applied Physics, 2014. 115(10).
- [5] Plimpton, S., Journal of Computational Physics, 1995. 117(1): p. 1-19

Nonlinear feedback-driven laser-material interactions

F. Ö. Ilday

Bilkent University, Ankara, Turkey;
e-mail: ilday@bilkent.edu.tr

Ultrafast laser-material processing has always been idealized as a one-way interaction – the laser beam modifies the material – the end. The possibility of laser-induced changes in the material modifying the laser beam, in return, and that this could open new doors was overlooked. By deliberately exploiting such interactions, we have demonstrated several striking advances, including creation of laser-induced surface nanostructures with unprecedented uniformity [1], a new regime of ultrafast laser-material ablation [2], self-organized 3D structuring of silicon [3], self-assembly of nanoparticles [4], and even a new form of optical trapping [5], among others. Our approach was originally inspired by mode-locking of lasers, whereby modes that lock up in phase experience preferential “gain“ over having random phases, and a coherent structure in time emerges spontaneously. We apply the same principle to design the form of the nonlinear feedback in each of these cases, but the present approach is more general and in each case, it was successfully used to overcome stubborn problems through the judicious use of the nonlinear feedback mechanisms.

REFERENCES

- [1] B. Öktem, I. Pavlov, S. Ilday, H. Kalaycıoğlu, A. Rybak, S. Yavas, M. Erdogan and F. Ö. Ilday, “Nonlinear laser lithography for indefinitely large-area nanostructuring with femtosecond pulses,” *Nature Photon.* 7, 897-901 (2013).
- [2] C. Kerse, H. Kalaycıoğlu, P. Elahi, B. Çetin, D. K. Kesim, Ö. Akçaalan, S. Yavaş, M. D. Aşık, B. Öktem, H. Hoogland, R. Holzwarth, and, F. Ö. Ilday, “Ablation-cooled material removal with ultrafast bursts of pulses,” *Nature* 537, 84-88 (2016).
- [3] O. Tokel, A. Turnalı, G. Makey, P. Elahi, T. Çolakoğlu, E. Ergeçen, Ö. Yavuz, R. Hübner, M. Zolfaghari Borra, I. Pavlov, A. Bek, R. Turan, D. K. Kesim, S. Tozburun, S. Ilday, F. Ö. Ilday, “In-chip microstructures and photonic devices fabricated by nonlinear laser lithography deep inside silicon,” *Nature Photon.* 11, 639-645 (2017).
- [4] S. Ilday, G. Makey, G. B. Akgüç, Ö. Yavuz, O. Tokel, I. Pavlov, O. Gülseren, F. Ö. Ilday, “Rich complex behavior of self-assembled nanoparticles far from equilibrium,” *Nature Commun.* 8, 14942 (2017).
- [5] F. Kalantarifard, P. Elahi, G. Makey, O. M. Marago, F. Ömer Ilday, G. Volpe, “Intracavity optical trapping of microscopic particles in a ring-cavity fiber laser,” to appear in *Nature Communications*.

Ultrafast laser-driven dynamic adaptive colloidal crystals

S. Ilday

UNAM-National Nanotechnology Research Center and Institute of Materials Science and Technology, Bilkent University, Turkey;
e-mail: serim@bilkent.edu.tr

Nature demonstrates an immense variety of dynamic adaptive self-assembled patterns particularly as part of living organisms. Operating in ‘noisy’ environments far from equilibrium, these patterns can self-regulate, self-heal, self-replicate, co-exist, compete, adapt, morph, and evolve. But how? How do complex phenomena emerge when large numbers of simple constituents interact dynamically? What happens differently far from equilibrium, and why? Understanding and steering emergent phenomena far from equilibrium is a grand challenge of condensed matter, statistical and nonlinear physics. After giving a brief historical introduction to pattern formation, I will show emergence of simple, complex and exotic patterns from ultrafast laser-driven polystyrene colloidal spheres (500-nm diameter) with no specific interactions between each other. I will also show excellent spatio-temporal control over these dynamic adaptive crystals and discuss their formation mechanisms as well as adaptive behavior.

Femtosecond and nanosecond laser - matter interaction and ablation technologies

N. A. Inogamov¹, S. I. Anisimov¹, V. V. Zhakhovsky², Y. V. Petrov^{1,3},
V. A. Khokhlov¹, D. K. Il'nitsky², and K. P. Migdal²

¹Landau Institute for Theoretical Physics of the Russian Academy of Sciences, 1-A Akademika Semenova av., Chernogolovka, Moscow Region, 142432, Russian Federation

²Dukhov Research Institute of Automatics, 22 Sushchevskaya st., Moscow, 127055, Russian Federation;

³Moscow Institute of Physics and Technology, 9 Institutskii per., Dolgoprudny, Moscow Region, 141700, Russian Federation

e-mail: nailinogamov@gmail.com

In this report the results obtained during last few years are presented. We are interested in physics of ablation and important technological applications. We have considered laser ablation in liquid which is used for formation of colloidal solutions of nanoparticles (DOI: 10.1134/S1063776118070075, DOI:10.1134/S0021364018190086 and arXiv: 1811.11990 1812.09109 1812.09929). Physics of laser ablation in liquid is complicated. How ablation proceeds depend on duration of a pulse and amount of energy absorbed by a target. While final stages when a bubble in liquid appears look similar for different durations. At the same time, the surface submicron structures created under liquid environment are qualitatively different for short and long durations. Recent observations (doi: 10.1063/1.5026591 10.1016/j.apsusc.2018.11.199) of such structures made in different liquids under ultrashort pulse actions are explained.

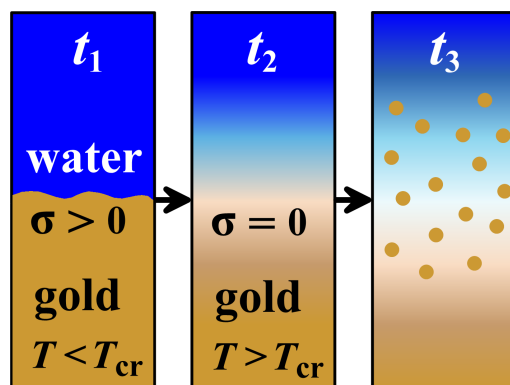

Absorbed energy F defines physics of mixing between liquid and metal, see the scheme shown in Figure. The liquid accepts condensate (nanoparticles), gently reducing their high initial velocity. Metal's pressure and temperature may be higher than that at the critical point: F is fluence. Then a separating surface barrier disappears because surface tension is zero. Then direct mutual diffusion occurs. Condensation of atoms (production of nanoparticles) proceeds as the diffusion layer slowly expands and cools.

Propagation and evolution of compression waves into shock for short and long durations are considered. These waves are created after absorption of a laser pulse on a boundary between transparent liquid and metal.

Studies of formation of micro- and nano- solitary surface structures by tightly focused laser beam are presented (see, e.g., DOI: 10.1103/PhysRevApplied.8.044016). These studies are important for a wide range of modern industrial applications including printing of metasurfaces for microelectronics, plasmonics, and sensors.

Work was done for the government order (0033-2019-0007).

Modeling of Laser Induced Periodic Surface Structures on Metals due to an Ultrashort Laser Pulse in Different Media

D. S. Ivanov^{1,2,3}, P. N. Terekhin², O. Benhayoun¹, A. Blumenstein⁴,
J. Oltmanns⁴, F. Kleinword⁴, B. Rethfeld², J. Ihlemann⁴, P. Simon⁴ and
M. E. Garcia¹

¹ University of Kassel, 34132 Kassel, Germany

² Technical University of Kaiserslautern and OPTIMAS RC, 67663 Kaiserslautern, Germany

³ Quantum Radio-Physics Department, Lebedev Institute of Physics RAS, Moscow, Russia

⁴ Laser-Laboratorium Göttingen e.V., 37033 Göttingen, Germany

e-mail: ivanov@uni-kassel.de

Ultrashort laser pulses, focused on metal surfaces, can produce Laser-Induced Periodic Surface Structures (LIPSS), which have found a lot of applications in IT- and Bio- technologies. During the laser energy deposition Surface Plasmon Polaritons (SPP) [1], i.e. surface plasmons coupled to a laser-electromagnetic wave, can be excited on a rough material surface. The interference of the plasmons wave and the incoming pulse leads to the redistribution of the laser intensity across the material's surface, establishing of the periodic electronic temperature field, (fig.1), and the subsequent formation of LIPSS.

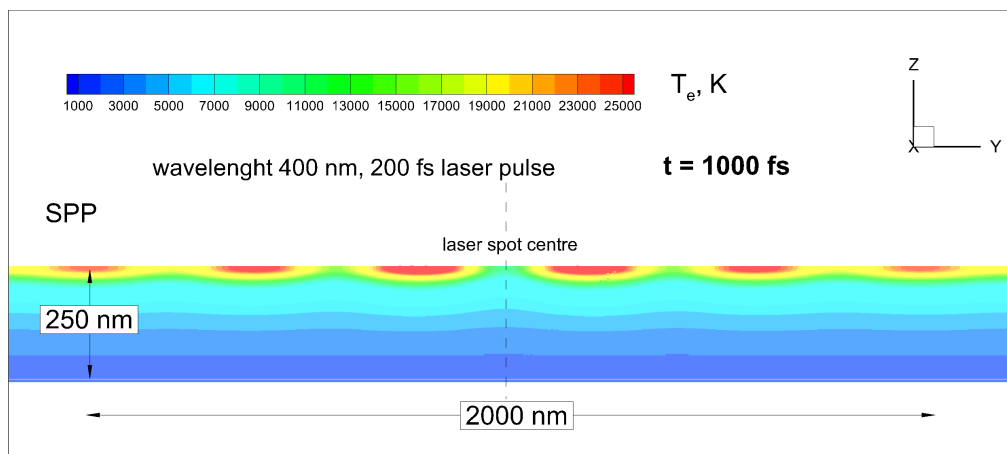

Figure 1: The resulting electronic temperature distribution inside the metal target (side view) upon 200 fs laser pulse energy deposition at the wavelength of 400 nm, due to excitation of SPP in the vicinity of the laser spot center.

In this work we propose a combined atomistic-continuum Molecular Dynamics based approach as an efficient numerical tool for investigation of LIPSS formation mechanism on metals in super-large simulations [2]. We introduce the corresponding source term description due to SPP in the combined model [3]. The nanostructuring mechanism is then investigated under conditions of vacuum ambient and in the regime of spatial confinement due to a thick water layer above the target. The simulation results are directly compared with the experimental data, generated on the same temporal and spatial scales, and analyzed. This allowed to extract the main mechanisms of LIPSS formation and the reasons

for a higher quality of structures generated under water. The performed research allows for a possibility of the manipulation with the laser parameters and surrounding media for generation of the structures with predesigned properties.

REFERENCES

- [1] S.A. Maier, *Plasmonics, Fundamentals and Applications* (Springer, Berlin) (2007).
- [2] D.S. Ivanov, V.P. Lipp, et.al., *Phys. Rev. Appl.* 4, 064006 (2015).
- [3] P.N. Terekhin, O. Benhayoun et.al., submitted to *Appl. Surf. Sci.* (2019).

Plasmonic effects in laser-structured thin Au-Pd films to produce hydrogen sensors

A. K. Ivanova¹, S. I. Kudryashov¹ and A. A. Ionin¹

¹ P.N. Lebedev Physical Institute of the Russian Academy of Sciences, 53, Leninskiy Prospekt, Moscow, Russia;
e-mail: mephynastya@gmail.com

Thin metal films are of great interest to the scientific community. Plasmon structures obtained on thin films as sensors have a number of advantages compared with other types of sensors: small size, large sensitivity, simplicity in creation and use. The use of such sensors can be found in areas where registration of hydrogen emissions into the atmosphere is necessary [1, 2].

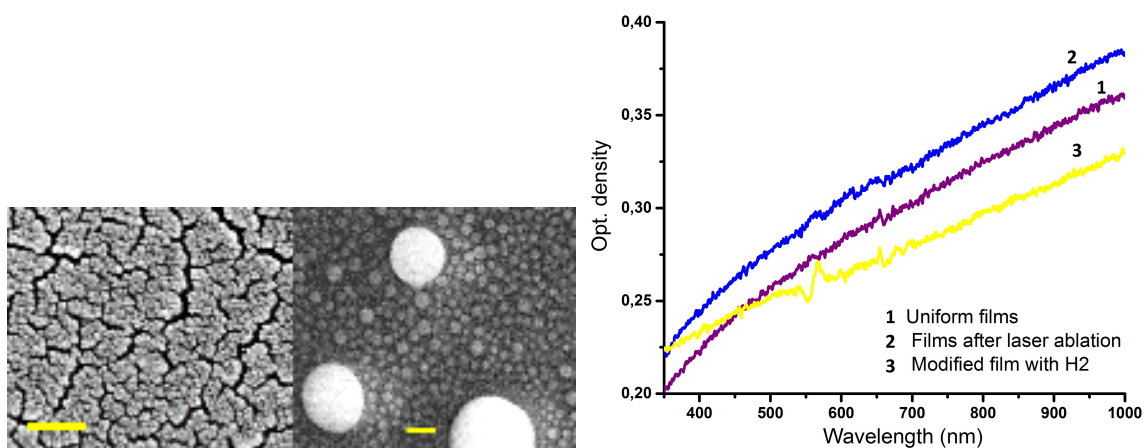

Figure 1: (left figure) Surface thin Au-Pd film before laser ablation (left) and after laser ablation (right). Label 100 nm. (right figure) Optical density thin Au-Pd film.

In this work, plasmon structures were created by single-pulse nanosecond laser pulses on the surface of a thin Au-Pd film. A thin Au-Pd film was deposited by magnetron sputtering on a glass slide. Its thickness was about 50 nm. The exposure was made by ytterbium fiber laser with a wavelength of 1064 nm, a pulse duration of 120 ns, a pulse repetition rate of 20 kHz, and an energy per pulse of up to 1 mJ. The movement of the laser beam was controlled by a computer. Various ways of filling the scanning area were investigated, which resulted in the formation of various patterns on the surface of a thin film. A change in the film homogeneity was observed in a scanning electron microscope (Fig. 1). Laser radiation contributed to the remelting of the film material on the formation of spherical nanoparticles of various sizes. Optical density of thin films after laser scanning of the surface in the range of 300-1000 nm have features in the red region (Fig. 2) associated with the interaction of volume plasmon oscillations and localized plasmons on nanoparticles. These features change their shape after reacting with hydrogen.

Thus, the possibility of creating compact hydrogen sensors based on laser structured thin gold-palladium films is presented.

REFERENCES

- [1] F. Sterl, H. Linnenbank, T. Steinle, F. Mörz, N. Strohhfeldt, H. Giessen, *Nano Lett.*, 18(7), 4293-4302 (2018).
- [2] T. D. James, P. Mulvaney, A. Roberts. *Nano Lett.*, 16(6), 3817-3823 (2016).

Formation of silicon nanoparticles via laser ablation of silicon nanowires in liquids

F. V. Kashaev, D. V. Shuleiko, A. V. Skobelkina, A. V. Kolchin and
P. K. Kashkarov

Faculty of Physics, Lomonosov Moscow State University, Moscow, Russia
e-mail: kashaev.fedor@gmail.com

In recent decades researchers have shown particular interest to properties of composite materials representing a variety of related nanoscale particles. Based on such composites it is possible to create materials with new structural and optical properties. The main factors leading to a significant modification of properties are quantum size effect and highly developed surface of nanomaterials. Silicon (Si) nanoparticles present special interest due to biocompatibility, biodegradability and low toxicity of Si. Quantum-size effect in small Si particles (< 7 nm) leads to effective photoluminescence (PL) in the visible and near infrared range, corresponding to transparent diagnostic window of the biotissue (700-1300 nm). Ensembles of silicon nanowires (SiNW) with a diameter of about 100 nm are also promising for photonics, since they can be used to create highly efficient sensors and photovoltaic devices. Compared to the original c-Si, SiNW structures show an increase in the total (specular and diffuse) reflection coefficient in the near-infrared (IR) and its significant decrease in the visible ranges and an increase in the efficiency of Raman scattering (RS) due to the fact that the transverse dimensions of nanowires are usually smaller or comparable with the wavelength of visible light [1]. The aim of this work was studying of structural and optical properties of Si nanoparticles formed by ablation of SiNW.

To solve this task, Si nanoparticles are formed by picosecond laser ablation (1064 nm, 30 ps, 10 Hz, 17 J/cm²) of SiNW in liquids (distilled water, ethanol). SiNW were performed before by metal stimulated chemical etching of Si.

Raman spectroscopy revealed the crystalline Si TO phonon mode with some red shift and broadening indicating the presence of a quantum-size effect in Si nanocrystals. In the formed samples also PL was observed with different maximum for particles obtained in water and ethanol, but in all cases the maximum was in transparent diagnostic window of the biotissue, that makes it possible to use such nanoparticles as photoluminescent markers inside the living organisms for medical diagnosis.

The work is supported by the Russian Foundation for Basic Research (project 18-32-00884).

REFERENCES

[1] L.A. Osminkina, V.A. Sivakov, G.A. Mysov *Nanoscale Res.* (vol. 9), art. 463 (2014).

Long range focusing of fs surface plasmon pulses

V. V. Klimov

Lebedev Physical Institute, Leninskij prospect 53, Moscow, Russia
e-mail: klimov256@gmail.com

The theory of 2D plasmon optics at the metal - dielectric interface is developed and applied to description of focusing cw and fs plasmon waves. As an example, in Fig.1 focusing cw surface plasmons by cylindrical slits of 500 mcm radius is shown.

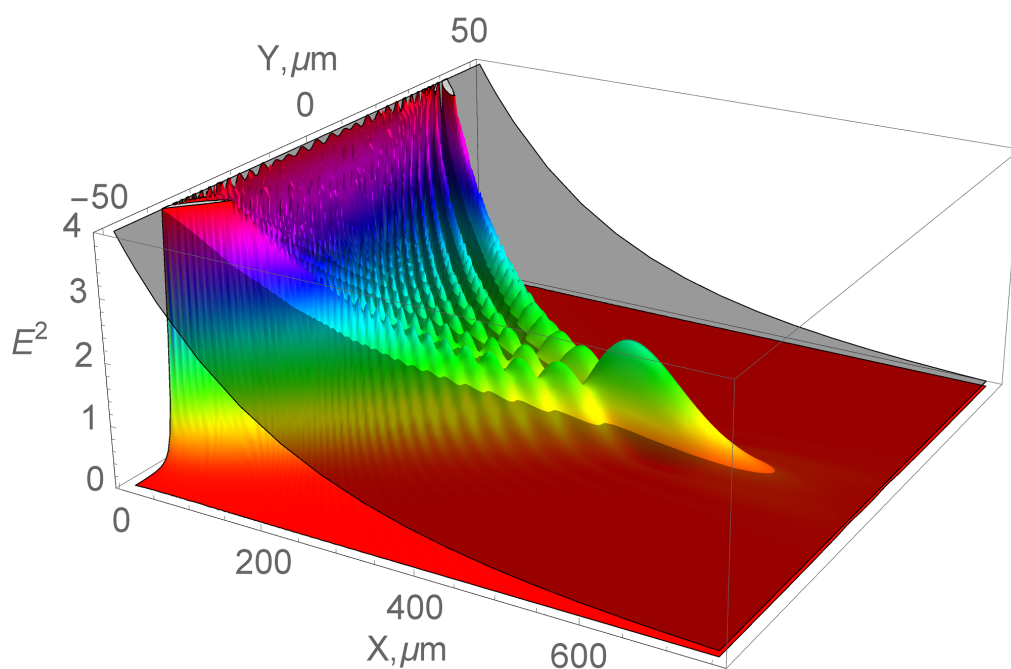

Figure 1: Focusing cw surface plasmons by cylindrical slits of 500 mcm radius.

It is shown that broadening of fs pulses during propagation is not very large and allow to provide wide band information transmission on the distance of several mm.

The acoustic properties of single strained $\text{Si}_{1-X}\text{Ge}_X/\text{Si}$ layer in subterahertz frequency range

A. Yu. Klokov¹, V. S. Krivobok¹, A. I. Sharkov¹, V. A. Tsvetkov¹, D. N. Lobanov², and V. P. Martovitsky¹

¹P.N.Lebedev Physical Institute of the Russian Academy of Sciences, Leninskii pr. 53, Moscow, 119991, Russia

²Institute for Physics of Microstructures RAS, GSP-105, Nizhny Novgorod, 603950, Russia;

e-mail: klokovay@lebedev.ru

As is known, a characteristic feature of semiconductor superlattices is the presence of phonon stop bands, which are a direct consequence of phonon interference in a periodic structure. In particular, for a periodic SiGe/Si structure containing tens to hundreds of periods, which can be monolithically integrated with silicon technology, the thermal conductivity can be 1[~]2 orders of magnitude less than the thermal conductivity of bulk Si and Ge. At the same time, flexible control of the phonon transmission spectrum, including implementation of aperiodic SiGe heterostructures, requires detailed data on the transmission and reflection of acoustic phonons by an individual layer of small thickness, comparable with the characteristic wavelengths (~ 10 nm) of subterahertz and terahertz phonons in silicon [1].

In this work, the pump-probe method was used to study the scattering of coherent acoustic phonons in strained SiGe/Si heterostructures with uniform SiGe layers as well as layers in which the initial stage of formation of self-organizing islands is observed. The use of structures with two nominally identical SiGe layers forming the simplest phonon interferometer allowed us to determine the reflection/transmission coefficients of phonons for a single strained SiGe layer and to study its lateral (acoustic) homogeneity.

It was shown that, in the range of germanium concentrations of 10[~]32%, the averaged acoustic properties of a strained SiGe layer ~ 10 nm thick do not depend on inhomogeneities caused by the loss of plane crystallization front, and elastic stresses. Sound speed and acoustic impedance of strained SiGe layers can be calculated using elastic parameters of relaxed SiGe solid solution with the same germanium concentration within the 3% error.

The work was supported by Russian Foundation for Basic Research, grant no 19-02-00952-a.

REFERENCES

[1] M. Maldovan, Phys. Rev. Lett, 110, 025902 (2013).

Visualization of coherent and incoherent twinning systems in crystalline CdZnTe by surface acoustic waves

A. Yu. Klokov, V. S. Krivobok, A. I. Sharkov, V. A. Tsvetkov, D. F. Aminev

P.N.Lebedev Physical Institute of the Russian Academy of Sciences, Russia
e-mail: klokovay@lebedev.ru

Detailed studies of extended defects in Group II-VI semiconductors and heterostructures based on them require methods that provide information about both the imperfections of the crystal structure and modifications in the electronic subsystem caused by these imperfections.

For the solution of the first problem, the use of non-contact optical methods that allow to determine crystallographic orientation and to monitor its local disturbances by analyzing the propagation pattern of surface acoustic waves (SAWs) may be promising[1]. Together with conventional optical microscopy and spectroscopy, these methods enable combined studies of the crystal structure, electron spectrum, and dynamic processes in the electron subsystem with a spatial resolution of about $1 \mu m$. A previous study of SAW propagating along low-symmetry surfaces of CdZnTe single crystals[2] shown that the problem of determining the local crystallographic orientation can be solved with reasonable accuracy.

The main goal of this work was to investigate the scattering of SAWs by the boundaries of coherent and incoherent twins, and also twinning systems emerging at the crystal surfaces using the methods of picosecond acoustics (pump-probe).

In CdZnTe single crystals with (111) and surface orientations, we investigate the influence of both coherent and incoherent twin planes on the SAW propagation pattern. We confidently observe the anisotropic scattering of Rayleigh and pseudosurface waves, accompanied by a significant attenuation of SAW passing through the boundaries. We show that the magnitude of this attenuation depends on the direction of SAW propagation. For directions corresponding to a high energy flux density, the formation of a reflected SAW beam was also observed. Upon the transition from a (111) to a crystal regions, the coherence or incoherence of the twin boundary is manifested in differences in the orientation of SAW pattern on the surface (with respect to the twin boundary). The waveguide propagation of SAW along a narrow twin fragment at the (111) crystal surface (so-called "lamellar twin") of CdZnTe single crystal was also observed.

This work was supported by Russian Foundation for Basic Research, grant no 19-02-00952-a.

REFERENCES

- [1]D. H. Hurley et al.,*Rhys. Rev. B*, 73, 125403 (2006).
- [2]A.Yu. Klokov et al.,*JETP Lett.*, 106, 503 (2017).

Femtosecond laser modification of amorphous germanium thin films and multi-layered germanium/silicon structures

A. V. Kolchin¹, D. V. Shuleiko¹, A. V. Pavlikov¹, S. V. Zobotnov¹,
L. A. Golovan¹, D. E. Presnov^{1,2,3}, V. A. Volodin^{4,5}, G. K. Krivyakin⁵,
A. A. Popov⁶

¹ Lomonosov Moscow State University, Faculty of Physics, Moscow, Russia;

² Lomonosov Moscow State University, Quantum Technology Center, Moscow, Russia;

³ Lomonosov Moscow State University, Skobeltsyn Institute of Nuclear Physics, Moscow, Russia;

⁴ Novosibirsk State University, Faculty of Physics, Novosibirsk, Russia;

⁵ Rzhanov Institute of Semiconductor Physics, Russian Academy of Sciences, Novosibirsk, Russia;

⁶ Yaroslavl Branch of Valiev Institute of Physics and Technologies, Russian Academy of Sciences, Yaroslavl, Russia;

e-mail: avkolchin@physics.msu.ru

Nowadays detection of optical infrared radiation and its transformation to electricity relate to application of thin-film structures based on amorphous germanium (a-Ge) and polymorphous germanium/silicon structures. One of approaches to modify their properties is the pulsed laser annealing [1, 2]. As a result, nanocrystalline areas are formed in the thin films. Such structures possess enhanced light absorbance and charge transport. The laser pulses of femtosecond duration are preferable in use, as they allow to achieve uniform nanocrystallization in comparison to longer one irradiation due to nonthermal effects in phase transitions during such treatment.

In our work the a-Ge film with 200 nm thickness and multi-layered film comprising 40 alternating amorphous germanium / amorphous silicon (a-Ge/a-Si) layers with thicknesses of 10 and 5 nm, respectively, were studied. Pulsed laser annealing was carried out using a Cr:forsterite laser (1250 nm, 0.5 mJ, 125 fs, 10 Hz). Structural properties were investigated by the scanning electron microscopy (SEM) and Raman spectroscopy with the excitation wavelength of 632 nm techniques.

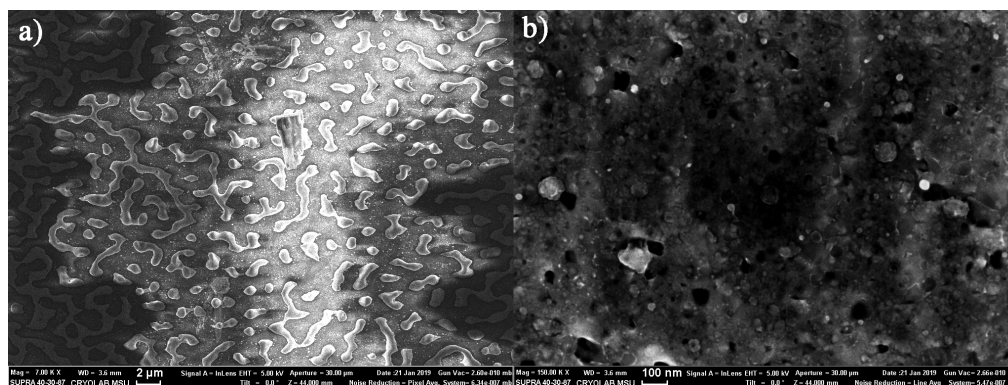

Figure 1: SEM-images of irradiated a-Ge thin film (a) and a-Ge/a-Si multi-layered structure (b).

The analysis of SEM images revealed that islet films are formed as a result of the a-Ge thin films femtosecond laser treatment (fig. 1a). In the case of the multi-layered a-Ge/a-Si sample the ripple formation on the irradiated areas was observed (fig. 1b). Most likely, such ripples are formed due to surface plasmon-polariton generation and consequent interference with incident radiation [3].

Raman spectroscopy of the initial samples showed amorphous structure of the germanium layers (a wide line near 270 cm^{-1}). Crystallization of the a-Ge after laser irradiation was confirmed by appearance of the line at 297 cm^{-1} in the Raman spectra (fig. 2a). Additionally, in case of multi-layered structure the line corresponding to Ge-Si bond (390 cm^{-1}) was observed. It can be explained by germanium atoms diffusion to silicon layer (fig. 2b).

Thus, in our work it was shown the possibility of germanium nanocrystals and ripples formation in the a-Ge and a-Ge/a-Si thin-layered films via femtosecond laser annealing. Such structures are of interest for following studies of their optical and electrophysical properties and use in photovoltaics and optoelectronics.

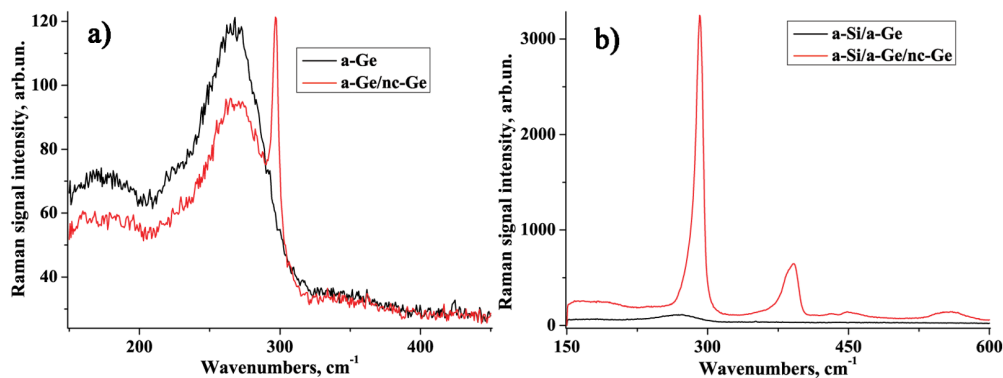

Figure 1: Raman spectra of initial and irradiated a-Ge thin film (a) and a-Ge/a-Si multi-layered structure (b).

REFERENCES

- [1] O. Salihoglu, U. Kürüm, H. G. Yaglioglu, et al., J. Appl. Phys. 109 (12), P. 123081 (2011).
- [2] V. A. Volodin, G. K. Krivyakin, G.D. Ivlev, et al., Semiconductors 53(1), 400 (2019).
- [3] D. V. Shuleiko, F. V. Potemkin, I. A. Romanov, et al., Laser Phys. Lett. 15, P. 056001 (2018).

Laser fabrication of microfluidic gradient textures on PMMA surface

I. V. Krylach¹, S. I. Kudryashov^{1,2}, R. O. Olekhovich¹, G. V. Odintsova¹ and
M. V. Uspenskaya¹

¹ St. Petersburg National Research University information technologies, mechanics and optics,
Saint-Petersburg, Russia

² P.N. Lebedev Physical Institute (LPI), Moscow, Russia;
e-mail: irina-krylach93@mail.ru

The process of creating gradient structures on the surface of polymethylmethacrylate (PMMA) under various modes of laser structuring is presented [1-2]. Structuring of the PMMA surface was carried out on MiniMarker 2 with the following laser radiation parameters: 10, 20, 30, 40% of the maximum power (20 W at 80 kHz), a period of 100 μm and a speed of 10 mm/s. The flow of a water droplet with a volume of 4 μl on the gradient structure is shown due to a change in the wetting angles, which are controlled by the laser radiation regimes.

REFERENCES

- [1] Kunz C., Müller F., Gräf S. Multifunctional hierarchical surface structures by femtosecond laser processing //Materials. - 2018. - V. 11. - N. 5. - p. 789.
- [2] Boinovich L. B., A. M. Emelyanenko, Hydrophobic materials and coatings: principles of creation, properties and applications //Uspekhi khimii. - 2008. - Vol. 77. - no. 7. - P. 619-638.

Direct laser printing of functional surfaces and microdevices with structured beams

A. Kuchmizhak^{1,2}

¹ Far Eastern Federal University, Vladivostok 690041, Russia;

² Institute of Automation and Control Processes, Far Eastern Branch, Russian Academy of Science, Vladivostok 690041, Russia;

e-mail: alex.iacp.dvo@mail.ru

Direct laser patterning of various materials using short- and ultrashort laser pulses has become a matured technology allowing rapid prototyping of multiple nanotextured morphologies, surfaces and devices. Utilization of structured laser beams for direct laser material processing provides unusual way for energy deposition into the irradiated target allowing to fabricate novel surface textures and morphologies with extended functionalities and unique properties. Here, we overview our recent results related to structured beam laser fabrication of various surface nanostructures and functional surfaces readily applicable for nanophotonic and sensory applications [1-4].

REFERENCES

- [1] S. Syubaev, A. Zhizhchenko, O. Vitrik, A. Porfirev, S. Fomchenkov, S. Khonina, S. Kudryashov, A. Kuchmizhak, *Applied Surface Science* (470), 526-534 (2019).
- [2] A. Zhizhchenko, S. Syubaev, A. Berestennikov, A.V. Yulin, A. Porfirev, A. Pushkarev, I. Shishkin, K. Golokhvast, A.A. Bogdanov, A.A. Zakhidov, A.A. Kuchmizhak, Y.S. Kivshar, S.V. Makarov, *ACS nano* (13), 4140 (2019).
- [3] D. Pavlov, S. Gurbatov, S.I. Kudryashov, P.A. Danilov, A.P. Porfirev, S.N. Khonina, O.B. Vitrik, S.A. Kulinich, M. Lapine, A.A. Kuchmizhak, *Optics letters* (44), 283 (2019).
- [4] D. Pavlov, S. Syubaev, A. Kuchmizhak, S. Gurbatov, O. Vitrik, E. Modin, S. Kudryashov, X. Wang, S. Juodkazis, M. Lapine, *Applied Surface Science* (469), 514 (2019).

Ultrafast dynamics in strongly electronically excited noble metals: search for super-plasmonic states

S. I. Kudryashov^{1,2}, A. A. Samokhvalov², P. A. Danilov¹, N. A. Smirnov¹,
S. N. Shelygina^{1,2}, N. I. Busleev¹, A. K. Ivanova¹, A. A. Rudenko¹,
S. G. Bezhanov¹, S. A. Uryupin¹, V. P. Veiko², A. A. Ionin¹

¹ Lebedev Physical Institute, Moscow, Russia;

² ITMO University, Saint-Petersburg, Russia;

e-mail: kudryashovsi@lebedev.ru

Over the past 5 years the authors explored ultrafast linear and nonlinear optical and electronic dynamics in transition metals [1-6], including the common plasmonic noble metals. Ultrafast broadband in situ spectroscopy was developed to reveal prompt band-filling [1,2] and plasmon-resonance blue-shifting.

The authors acknowledge the financial support of Russian foundation for basic research (grant N 17-02-00648) and Presidium of Russian academy of sciences (programs NN 7, 32).

REFERENCES

- [1] E. Golosov, A. Ionin, Yu. Kolobov, S. Kudryashov, A. Ligachev, Yu. Novoselov, L. Seleznev, D. Sinitsyn, JETP 113 (1), 14-26 (2011).
- [2] S. Bezhanov, P. Danilov, A. Ionin, S. Kudryashov, V. Lednev, S. Pershin, A. Rudenko, I. Saraeva, L. Seleznev, E. Sunchugasheva, S. Uryupin, D. Zayarny, Las. Phys. Lett. 13 (3), 035302 (2016).
- [3] S. Bezhanov, P. Danilov, A. Klekovkin, S. Kudryashov, A. Rudenko, S. Uryupin, Appl. Phys Lett. 112 (11), 113104 (2018).
- [4] S. Kudryashov, I. Saraeva, A. Rudenko, A. Ionin, Applied Surface Science 471, 23-27 (2019).
- [5] S. Kudryashov, A. Samokhvalov, E. Ageev, V. Veiko, JETP Lett. 109 (5), 298-302 (2019).
- [6] S. Kudryashov, P. Danilov, S. Bezhanov, A. Rudenko, A. Ionin, S. Uryupin, S. Umanskaya, N. Smirnov, JETP Lett. 109 (6), 382-386 (2019).

Abnormal oriented spatial surface nanograting formation by ultrashort laser radiation

V. S. Makin¹, R. S. Makin²

¹ Institute for Nuclear Energetic, Sosnovy Bor City, Russia;

² National Research Nuclear University "MEPHI", Moscow, Russia;

e-mail: makinvs@niiioep.ru

In physics of ultrashort laser-matter interaction the hot topic is the elucidation the mechanism of nanograting \mathbf{G} production of anomalous orientation, $\mathbf{G} \perp \mathbf{E}$, where \mathbf{E} is the electric field strength of laser radiation. One of the causes of such interest is the anomalously small periods D of such gratings. We present the review of the experimental publications causing anomalous nanogratings production on condensed media with sufficiently different physical properties and related mechanisms of their formation. The variety of proposed mechanisms of anomalous nanograting formation were analyzed: capillary waves generation, spallation of material, interference with surface plasmon polaritons (SPPs) participation, mutual interference of localized SPPs and others.

The model of mutual interference of localized (channel and wedge) SPPs (including their spatial harmonics) was analyzed in more details. The usual irradiation geometry and nonstandard one (for instance, the two-beam interference) for nanograting formation were considered. Special attention was devoted to periods of G which overcome the optical diffraction limit value and reach the values of the order of $D \leq \lambda/40$. The pure physical limitation on the smallest period value formation arises from the thermal grating smoothing due to thermal conductivity which do not permit the experimental realization more smaller values from the set of Feigenbaum's universality $\lambda/2k\zeta$ of higher k values, where ζ is the real part of the refractive index of nonequilibrium solid state plasma-air boundary for local SPPs, $k=1, 2, 4, \dots$. The experimentally realized values of the period D frequently overcome the Abbe criterion as a result of the nonlinear process of their production. We show that the universal polariton model takes place for ultrashort terahertz radiation interaction with matter. For such large wavelengths the process of thermal grating smoothing is less sufficient. That is why for terahertz radiation the smallest periods $D \leq \lambda/25$ ($\lambda \sim 100$ um) for monocrystalline silicon and $\leq \lambda/100$ for aluminum films were observed.

In summary, the phenomenon of anomalously oriented nanograting formation has universal character. It was shown, that known experimental results causing anomalously oriented gratings production are well explained in the model of mutual interference of local SPP's.

REFERENCES

[1] V. Makin, E. Logacheva, R. Makin. Optics and Spectroscopy. 4, 610 (2016).

Classical and Quantum Light Sources on Nanometer Spatial and Femtosecond Temporal Scales

P. N. Melentiev, V. I. Balykin

Institute of Spectroscopy, Moscow, Troitsk, Russia
e-mail: melentiev@isan.troitsk.ru

The key advantage of plasmonics is in pushing our control of light down to the nanoscale [1-4]. Here we demonstrate the development of the basic elements of plasmon optics and the classical and quantum light sources both on *nanometer spatial* scale and also on *femtosecond temporal* scale: plasmonic femtosecond interferometer, plasmonic femtosecond autocorrelator and quantum generators. It is possible to envision such plasmonic devices for future quantum information processing and cryptography.

REFERENCES

- [1] M. L. Brongersma, V. M. Shalaev, *Science*, 328, 440 (2010).
- [2] V.V. Klimov, *Nanoplasmonics*, Pan Stanford (2014).
- [3] V. I. Balykin, P. N. Melentiev, *Phys. Usp.* 61, 133 (2018).
- [4] V. I. Balykin, *Phys. Usp.* 61, 846 (2018)

Chemical functionalization of graphene on laser patterned surfaces

I. Mirza¹, P. Kovaříček⁴, M. Stehlík^{1,2}, J. Sládek^{1,2}, T. Derrien¹, N. M. Bulgakova¹, G. Račiukaitis³, K. A. Drogowska⁴, A. Rodriguez⁵, M. Kalbáč⁴

¹ HiLASE Centre, Institute of Physics of the Czech Academy of Sciences, Za Radnicí 828, 25241, Dolní Brezany, Czech Republic

² Faculty of Nuclear Sciences and Physical Engineering, Czech Technical University in Prague, Trojanova 13, 120 00 Prague, Czech Republic

³ Centre for Physical Sciences and Technology, Savanoriu Ave. 231, LT-02300 Vilnius, Lithuania

⁴ Department of Low-Dimensional systems, J. Heyrovský Institute of Physical Chemistry of the Czech Academy of Sciences, Prague, Czech Republic.

e-mail: mirza@fzu.cz

Tuning of graphene's properties is the cornerstone towards reaching its ultimate potential. Recent advances have shown that periodic modulation of the pristine characteristics, such as potential and/or chemical functionalization, can unlock otherwise unavailable features[1,2]. The reactivity of monolayer graphene also depends on the subtle substrate morphology, as a result nanopatterned substrates may provide a control over periodic modulation of chemical and physical properties of 2D-materials. Laser induced periodic surface structures (LIPSS) is a universal phenomenon which can be observed on a variety of materials[3]. It is generally accepted that the structures originate from the scattering of the laser wave on the surface roughness and may involve the excitation of Surface Plasmon Polaritons (SPP) [4]. LIPSS properties strongly depend on both materials properties and on the irradiation conditions[5]. Here we report the results of a detailed study of micro-Raman microscopy on chemically functionalized graphene transferred on SiO₂/Si substrates covered with LIPSS. Periodic surface structures were fabricated using laser scanning method by systematically varying the laser energy fluencies and the spatial overlap of the focused Gaussian beam. The irradiation was performed on the bulk target using pulsed laser operating at central wavelength of 1064 nm with a pulse duration of 10 ps. The CVD-grown monolayer graphene was transferred to LIPSS-covered SiO₂/Si samples using the polymer support method. Results show that periodicity and depth of LIPSS influences the topography of the transferred graphene monolayer by either replicating the shape of the LIPSS, or by forming a periodic suspended pattern. The periodic modification of both mechanical and electronic properties of the monolayer graphene were studied. The optimum LIPSS periodicity-to-depth ratio, stress-strain analysis and functionalization efficiencies for the suspended and supported regions of graphene will be discussed.

REFERENCES

- [1] Bottari, G. et al. ,Chem. Soc. Rev. 46, 4464–4500 (2017).
- [2] Plšek, J., Kovaříček, P., Valeš, V. & Kalbáč, M. , Chem. – Eur. J. 23, 1839–1845 (2017).

- [3] Bonse, J., Krüger, J., Höhm, S. & Rosenfeld, A. , J. Laser Appl. 24, 042006_1-042006_7 (2012).
- [4] Huang, M., Zhao, F., Cheng, Y., Xu, N. & Xu, Z. O, ACS Nano 3, 4062–4070 (2009).
- [5] Bonse, J., Höhm, S., Kirner, S. V., Rosenfeld, A. & Krüger, J. , IEEE J. Sel. Top. Quantum Electron. 23, 9000615 (2017).

Origin of fluence dependence of periodicity in nanostructuring on diamond-like carbon films with femtosecond laser pulses

G. Miyaji, S. Nikaido, T. Natori and R. Saito

Department of Applied Physics, Tokyo University of Agriculture and Technology, 2-24-16 Nakacho, Koganei, Tokyo 184-8588, Japan;
e-mail: gmiyaji@cc.tuat.ac.jp

We study on the excitation of the surface plasmon polaritons on nonmetallic materials with intense femtosecond (fs) laser pulses and the surface nanoablation with its plasmonic near-fields [1,2]. This paper reports the results of experiments on periodic nanostructure (PNS) formation on diamond-like carbon (DLC) films induced with 800-nm, 7-fs laser pulses at low fluence from a Ti:sapphire laser oscillator [3]. As shown in Fig.1(a) and (b), it is demonstrated that 7-fs laser pulses with a high power density I of 0.8-2 TW/cm² at a low fluence F of 5-12 mJ/cm² can form a PNS with a period d of 60-80 nm on DLC films. Figure 1(c) shows d of the PNS on the DLC film formed with the 7-fs laser pulses plotted as a function of F and I for a scanning speed of $\nu = 0.1$ μ m/s. The period decreases with increasing fluence of the laser pulses. The experimental results and calculations for a model target show that 7-fs pulses can produce a thinner metal-like layer on the DLC film through a nonlinear optical absorption process compared with that produced with 100-fs pulses, creating a finer nanostructure via plasmonic near-field ablation.

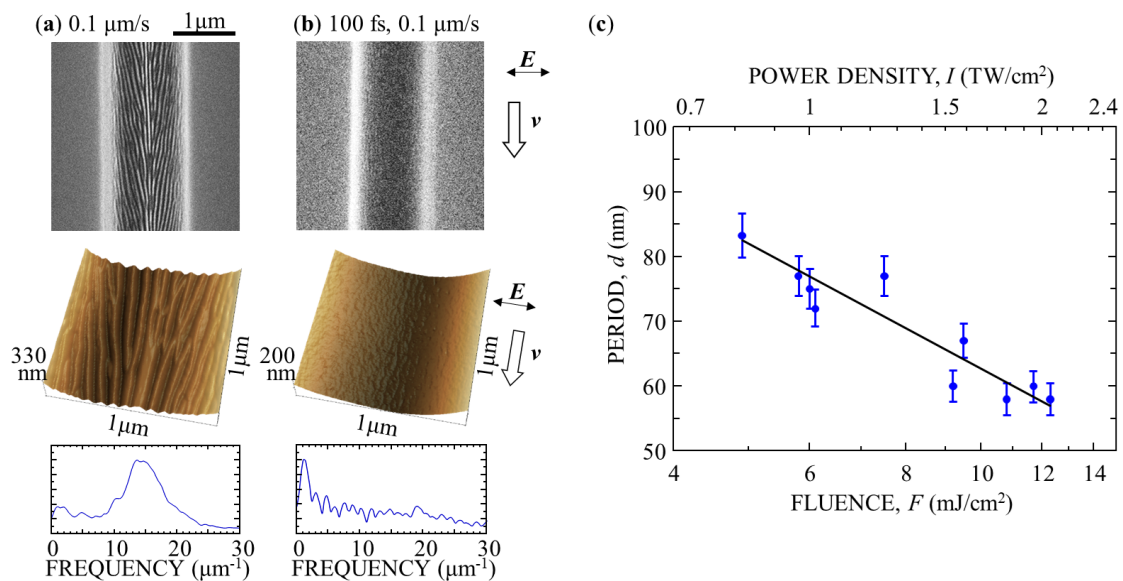

Figure 1: SEM images (top), SPM images (middle), and spatial frequency spectra (bottom) of DLC film surface irradiated for $\nu = 0.1$ μ m/s with (a) 7-fs pulses at $I = 1$ TW/cm², $F = 6$ mJ/cm² and (b) 100-fs pulses at $I = 0.1$ TW/cm², $F = 6$ mJ/cm². E and ν denote directions of polarization and laser scanning, respectively. (c) Period d of PNS on DLC film formed with 7-fs laser pulses as function of F and I for $\nu = 0.1$ μ m/s.

REFERENCES

- [1] G. Miyaji, M. Hagiya, and K. Miyazaki, *Phys. Rev. B* 96, 045122 (2017).
- [2] G. Miyaji and M. Hagiya, *Rapid Communication in Jpn. J. Appl. Phys.* 58, 050916 (2019).
- [3] S. Nikaido, T. Natori, R. Saito, and G. Miyaji, *Nanomaterials* 8, 535 (2018).

Fine beam shaping technique by spatial light modulator and $4f$ system for area processing

Y. Nakata¹, T. Aoyama¹, Y. Kosaka¹, E. Hayashi¹, H. Shiraga¹, N. Miyanaga²

¹ Osaka University, 2-6 Yamadaoka, Suita, Osaka, Japan;

² Institute for Laser Technology, 1-8-4 Utsubohommachi, Nishi-ku, Osaka, Japan;

e-mail: nakata-y@ile.osaka-u.ac.jp

A high quality square flattop beam is in demand for various fields, such as uniform laser processing[1-3]. Beam shape is key to realizing the laser's potential abilities and effects. However, since beam shape and wavefront vary by laser, beam shaping is essential for producing the desired shapes to respond to various needs. So, static and adaptive beam shaping methods have been developed for various applications. With Diffractive Optical Element (DOE) as a static method, edge steepness and flatness are low and wavefront becomes deformed after shaping (fig 1 (a)). In addition, computer-generated hologram (CGH) as a typical adaptive method has the same difficulties.

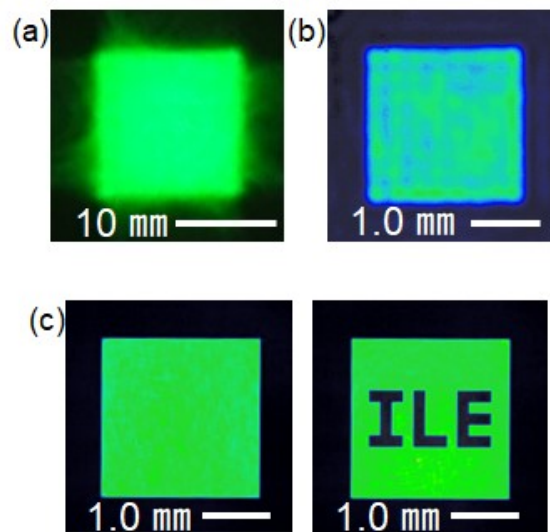

Figure 1: Square flattop beam profiles made by: (a) Diffractive Optical Element (DOE), (b) vertical phase grating (conventional method), (c) virtual diagonal phase grating (new method).

Meanwhile, an adaptive beam shaping technique that uses phase grating encoded on a spatial light modulator (SLM) with spatial-frequency filtering in the Fourier plane in a $4f$ system was developed (fig 2 (a))[4]. This conventional method generates a square flattop beam by spatially controlling diffraction efficiency without deforming the wavefront. However, because the extracted and residual components overlap in the Fourier plane, it was necessary to cut the high spatial-frequency (HSF) component from the extracted component, limiting the flatness and the edge steepness of the resultant beam shape (fig 1 (b)).

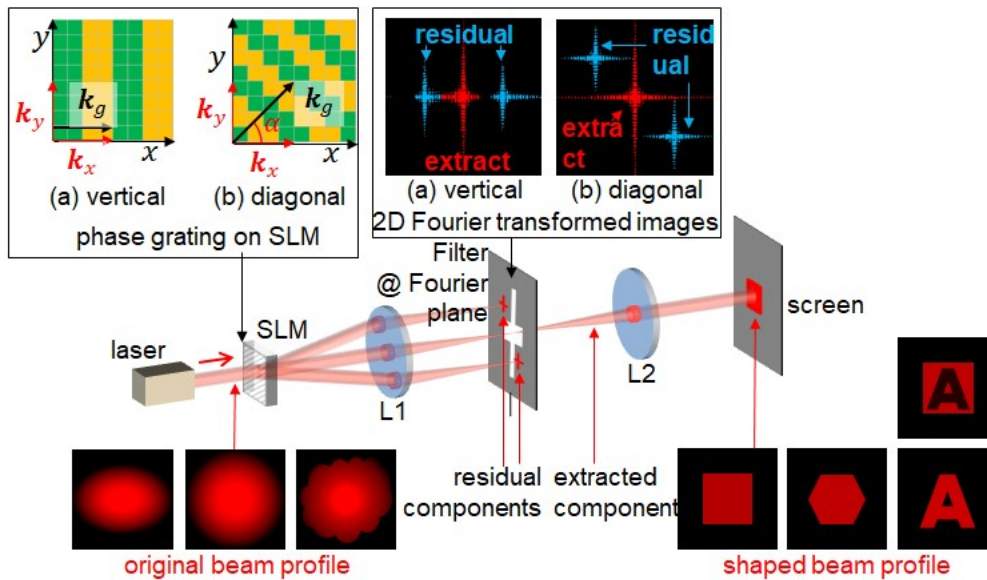

Figure 2: Experimental layout: phase grating and filtering in the Fourier plane of the 4f system. (a) vertical phase grating (conventional method), (b) virtual diagonal phase grating (new method).

In this study, we developed a universal beam shaping technique at high accuracy, which can be used for various lasers from ultraviolet to near-infrared domain[4]. This method spatially separates the residual and extracted components in the Fourier plane by using a virtual diagonal phase grating (fig 2(b)) and clears overlap by making the grating vector k_g non-parallel to the normal vectors k_x or k_y of the desired beam profile, which are parallel to each other in the conventional scheme. By efficiently using only extracted components containing HSF components, beam shaping at high resolution was achieved. This allowed for a highly uniform flattop beam of any cornered shape without ripples, suppressing the edge of the shaped beam to a height of 20 μm , which is less than 20% of that obtained with conventional vertical phase grating. Our method, which allows for optimization of beam shaping by improving resolution and accuracy, will contribute to a wide field, including basic research, manufacturing and medical engineering. In conventional beam shaping systems, beam shaping accuracy can be significantly enhanced at no extra cost simply by changing the spatial frequency filter and phase grating encoded on an SLM.

REFERENCES

- [1] Y. Nakata et al., Jpn. J. Appl. Phys. Part 2 Lett 42, L1452 (2003).
- [2] Y. Nakata et al., Appl. Surf. Sci. 274, 27 (2013).
- [3] Y. Nakata et al., Appl. Surf. Sci. 253, 6555 (2007).
- [4] Y. Nakata et al., Sci. Rep. 9, 4640 (2019).

Laser ablation of Au/Pd films

A. A. Nastulyavichus, S. I. Kudryashov, N. A. Smirnov, A. A. Rudenko,
D. A. Zayarny, A. A. Ionin

Lebedev Physical Institute, Leninskiy prospect 53, 119991 Moscow, Russianewline
e-mail: ganuary_moon@mail.ru

Bimetallic nanoparticles exhibit interesting optical, electronic and chemical properties due to new bi-functional or synergistic effects [1-2]. Gold-palladium (Au/Pd) nanoparticles and their assemblies have shown catalytic and structural properties. In this paper, nanoparticles were obtained from thin films by laser ablation in water. The films were deposited using a magnetron sputtering installation in an argon atmosphere.

As the source of radiation was used fiber laser marker HTF MARK (Bulat) on Yb^{3+} ions with pulse duration at half-height of 120 ns, maximum pulse energy of 1 mJ and pulse repetition rate up to 80 kHz. The radiation was focused by a galvanoscanner with a lens focal length of 160 mm. The optical properties of the obtained colloidal solutions were studied, and the nanoparticles were visualized by scanning (SEM) and transmission (TEM) electron microscopy (Fig.1). The chemical composition of the obtained bimetallic nanoparticles was confirmed by energy-dispersive x-ray spectroscopic chemical microanalysis (EDX).

This work was supported by the Presidium of RAS (Program 32 “Nanostructures: physics, chemistry, biology and fundamentals of technologies”).

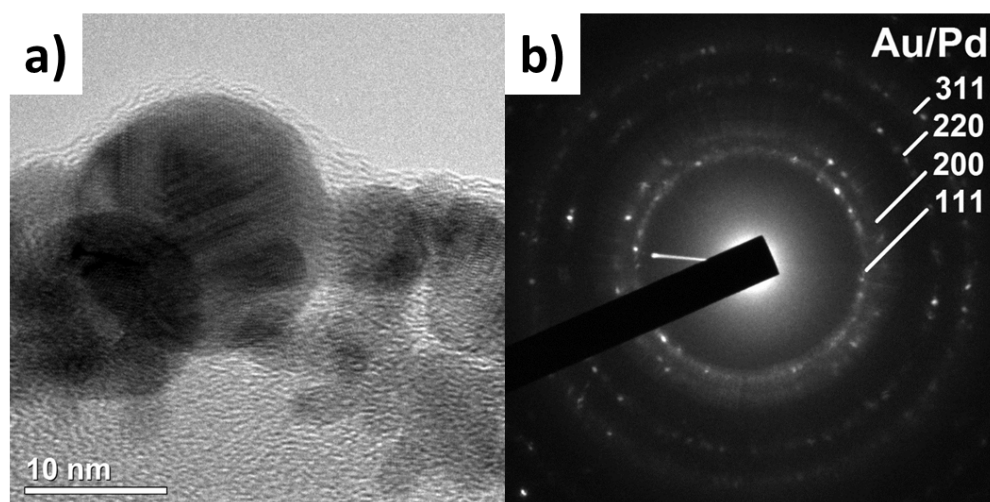

Figure 1: TEM image (a) and corresponding diffraction pattern (b) for Au/Pd bimetallic nanoparticles

REFERENCES

- [1] M. C. Daniel and D. Astruc, *Chem. Rev.* 104, 293 (2004).
- [2] C. J. Zhong and M. M. Maye, *Adv. Mater.* 13, 1507 (2001).

Inverse energy flux of focused radially polarized optical beams generated by metalenses

S. A. Degtyarev^{1,2}, S. N. Khonina^{1,2}, A. V. Ustinov² and A. P. Porfiriev^{1,2}

¹ Samara National Research University, Samara, Russia;

² Image Processing Systems Institute, Branch of the Federal Scientific Research Centre “Crystallography and Photonics“ of Russian Academy of Sciences, Samara, Russia;
e-mail: porfirev.alexey@gmail.com

Recently, the interest of researchers has focused on an inverse energy flux of nonparaxial laser beams, namely, the negative values of the Poynting vector in the local domain. It was shown [1] that the longitudinal component of the Poynting vector assumes the largest negative value on the optical axis in the case of circular polarization. The modulus of the negative minimum of the longitudinal component does not exceed 25%-30% of the positive maximum. We believe that this ratio can be increased by using a different beam type.

In this paper, we consider the formation of a negative energy flux in the case of tight focusing of an arbitrary-order radially polarized annular beam. Theoretically, using the Richards-Wolf formulas, the negative value of the energy flux density on the optical axis in the focal region for the second-order radial polarization is maximized. In this case, the local inverse energy flux as an integral characteristic in the bulk region of negative values increases with increasing order of the radial polarization. The validity of theoretical calculations is further justified by numerical calculations both using the Richards-Wolf formulas and in the framework of a rigorous electromagnetic theory. Analysis of theoretical expressions has shown that the maximization of the negative value of the energy flux density on the optical axis will occur in the case of second-order radial polarization ($m = 2$). In this case, the Debye model predicts a much larger relative value (by more than five times) of the inverse energy flux density in comparison with the results obtained previously in other papers.

The presence of an inverse energy flux extends the capabilities of optical trapping and manipulation. The action on the particles in this case will be similar to “tractor beams“ [2], meaning that the light does not push the particles forward in the direction of propagation, but pulls it back. Furthermore, the presence of an inverse energy flux is useful in the detection of invisibility cloaks and other applications.

REFERENCES

- [1] A. V. Novitsky and D. V. Novitsky, *J. Opt. Soc. Am. A* (24), 2844 (2007).
- [2] S. Sukhov and A. Dogariu, *Opt. Lett.* (35), 3847 (2010).

Ultrafast laser-induced modifications in materials

S. A. Romashevskiy¹

¹ Joint Institute for High Temperatures of the Russian Academy of Sciences (JIHT RAS), Moscow, Russia;
e-mail: sa.romashevskiy@gmail.com

Material processing at the nanoscale, highly localized morphological and structural modifications of various materials, including nanometer-scale layer removal, formation of nanoscale surface structures, nanofoaming, amorphization and re-crystallization, are of particular interest to semiconductor industry, optoelectronics, solar power engineering and biomedical applications.

Ultrafast laser-induced modifications in materials have been drawing much attention for the last several decades. Material processing with ultrashort laser pulses has evolved into a high performance and scalable technology for versatile modification of a wide range of materials without needing a high-cost clean room environment and photomasks. While the ultrashort energy deposition results in a minimal heat affected zone, the state-of-the-art scanning systems allow to process material at several hundred meters per second. Notwithstanding the scientific and technological progress in surface engineering with ultrafast lasers, little attention has been brought to selective and localized modification at the nanoscale. However, depositing high energy densities into material's electronic subsystem in an ultrashort period of time (< 500 fs) in a specified environment allows to control the morphology of a material accurate within several nanometers [1-3]. What are the potentialities of ultrashort laser pulses regarding selective modification of nanometer-scale layers? Are femtosecond laser pulses capable of being utilized as a high-precision and easy-to-use tool to modify the surface layers accurate within several nanometers or even less? In this study new experimental results on selective processing of perspective optoelectronic materials with ultrashort laser pulses are presented.

REFERENCES

- [1] S. A. Romashevskiy, S. I. Ashitkov, and M. B. Agranat, *Appl. Phys. Lett.* 109, 261601 (2016).
- [2] S. A. Romashevskiy, *Tech. Phys. Lett.* 44 (7), 630 (2018).
- [3] S. A. Romashevskiy, P. A. Tsygankov, S. I. Ashitkov, and M. B. Agranat, *Appl. Phys. A* 124, 376 (2018).

Single-shot femtosecond laser ablation of thin gold films: the study of the primary nanoparticles formation

I. N. Saraeva¹, A. A. Nastulyavichus¹, S. I. Kudryashov^{1,2}, A. A. Rudenko¹,
D. A. Zayarny¹, A. A. Ionin¹

¹ P.N. Lebedev Physical Institute of the Russian Academy of Sciences, Moscow, Russia

² ITMO University (Saint-Petersburg National Research University of Information Technologies, Mechanics and Optics), Saint-Petersburg, Russia

e-mail: insar@lebedev.ru

Single-shot infrared (1030 nm) femtosecond (300 fs) laser ablation of 60-nm Au film, sputtered on a Si substrate, in air and isopropyl alcohol (IPA) allowed to spectrally and visually detect the primary nanoparticles (NPs), forming during laser-induced melt ejection. Arrays of microcraters were formed on a sample with laser energy varying from 3 uJ up to 7 uJ in air or under the ~ 400 μm layer of isopropyl alcohol. The resulting morphology of craters was visualized by means of scanning electron microscopy (SEM, JEOL JSM 7001M) (Fig. 1a, b, d, e). Nanoparticles, formed during laser ablation in air and liquid, have different morphology and size. According to the SEM-acquired NP size distributions, the main fraction of particles reaches ~ 100 -150 nm, while in IPA the mean diameters correspond to ~ 10 -20 nm.

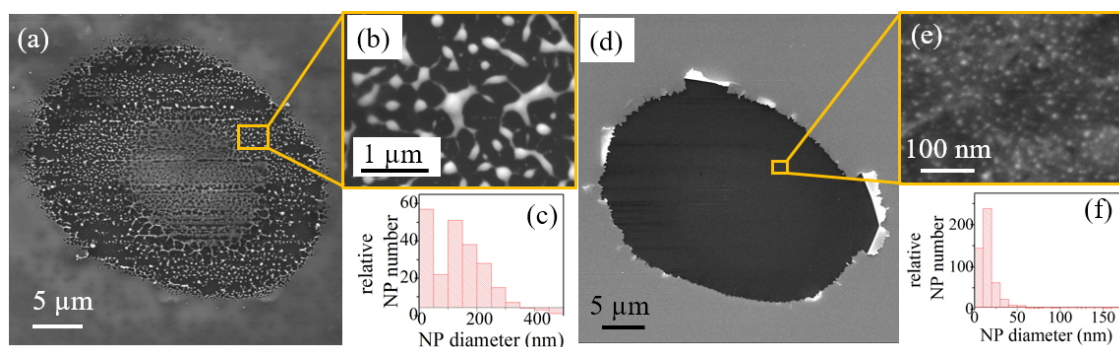

Figure 1: SEM images of microcraters (general view and enlarged areas inside the craters) on a gold film, ablated in IPA (a, b) and air (d, e) with the corresponding NP size distributions (laser energy $E \simeq 3$ uJ).

The reflectance spectra of the ablated NPs inside the crater were registered using a spectrophotometer MSFU-K (LOMO) in the range 400-800 nm with a 0.1-mm diaphragm for a 20x lens (Fig. 2). The initial spectrum of unprocessed Au film reflectance demonstrates a broad and significantly shifted peak, corresponding to localized plasmon resonance in gold nanocrystallites with high polydispersity [1].

The peculiarities of spectra, acquired at different energies, the corresponding NP size distributions and SEM analysis of ablation products morphology allow suggesting the mechanisms of NPs formation during single-shot laser ablation in air and liquid (isopropyl alcohol).

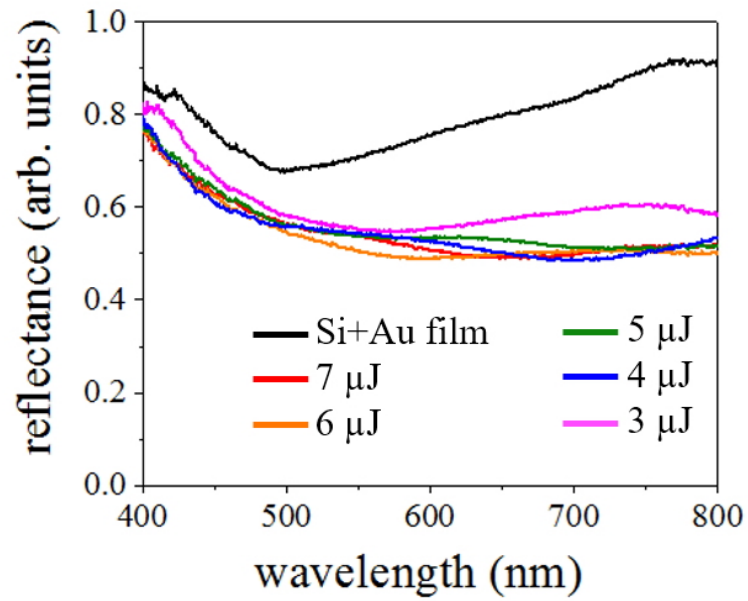

Figure 2: Reflectance spectra of Au NPs inside the microcraters, acquired at laser energies $E \simeq 7-3 \text{ uJ}$ in air and the unprocessed Au film on Si substrate (black curve).

REFERENCES

- [1] V. Amendola, R. Pilot, M. Frasconi, O. Maragó, M. Iati, *J. Phys.: Condens. Matter* (29) 203002 (2017).

Photoinitiated processes on titania for bionic devices and infochemistry

N. V. Ryzhkov, P. Nesterov, K. Nikolaev and E. V. Skorb

ITMO University, Lomonosova str. 9, Saint Petersburg 191002, Russia
e-mail: skorb@scamt-itmo.ru

We are interested how to use light regulated feedback sustainable systems and control biodevices to the current focus on infochemistry in aqueous solution [1, 2]. A major part of the work focuses on the photogeneration and use of localized ion concentration gradient. In situ scanning vibration electrode (SVET) and scanning ion-selective electrode techniques (SIET) are efficient for photo-generated spatiotemporal evolution of ions on the pristine titania surface vs. covered with polyelectrolytes (PEs), here polyethylenimine (PEI), poly(sodium styrene sulfonate) (PSS) multilayers as well as lipid bilayer (Figure 1).

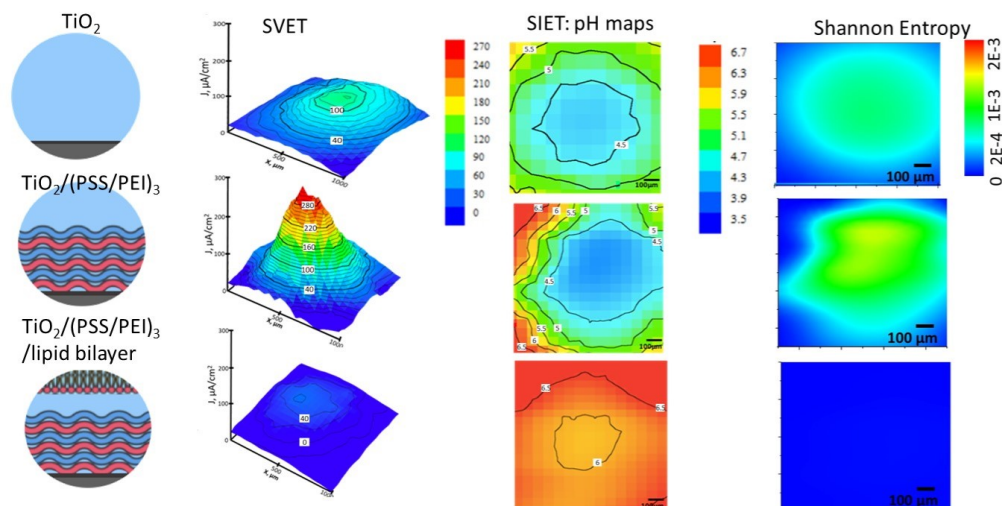

Figure 1: Thin polyelectrolyte layers and lipid bilayer as “nanoregulator“ of surface photochemistry

We show that pH-regulated PEs multilayers can change their properties – film thickness and stiffness, permeability, hydrophilicity, and / or fluorescence – in response to irradiation instead of the classical acid/base titration

REFERENCES

- [1] N. V. Ryzhkov, D. V. Andreeva, E. V. Skorb, *Langmuir*, DOI: 10.1021/acs.langmuir.9b00633 (2019).
[2] N. V. Ryzhkov, P. Nesterov, N. A. Mamchik, S. O. Yurchenko, E. V. Skorb, *Frontiers in Chemistry*, DOI: 10.3389/fchem.2019.00419 (2019).

Single-shot femtosecond laser ablation of gold

N. A. Smirnov¹, S. I. Kudryashov^{1,2}, A. A. Nastulyavichus¹, A. A. Ionin¹

¹ Lebedev Physical Institute, Leninskiy prospect 53, 119991 Moscow, Russia

² ITMO University, St. Petersburg, Russia

e-mail: cna1992@mail.ru

Installations with ultrashort laser pulses are widely used for various technological operations to modify the surface of materials. In this case, for different pulse durations, the material ablation thresholds can significantly vary, which in turn are one of the key parameters for laser processing [1]. Gold was chosen as a target. In this paper, the ablation thresholds for the gold were experimentally obtained. In the course of the experiment, laser ablation of the gold surface in water and air with a variable pulse duration was carried out. Fig. 1 shows the visualization of the craters using a scanning electron microscope (SEM) for different numerical apertures (NA=0.25; 0.65).

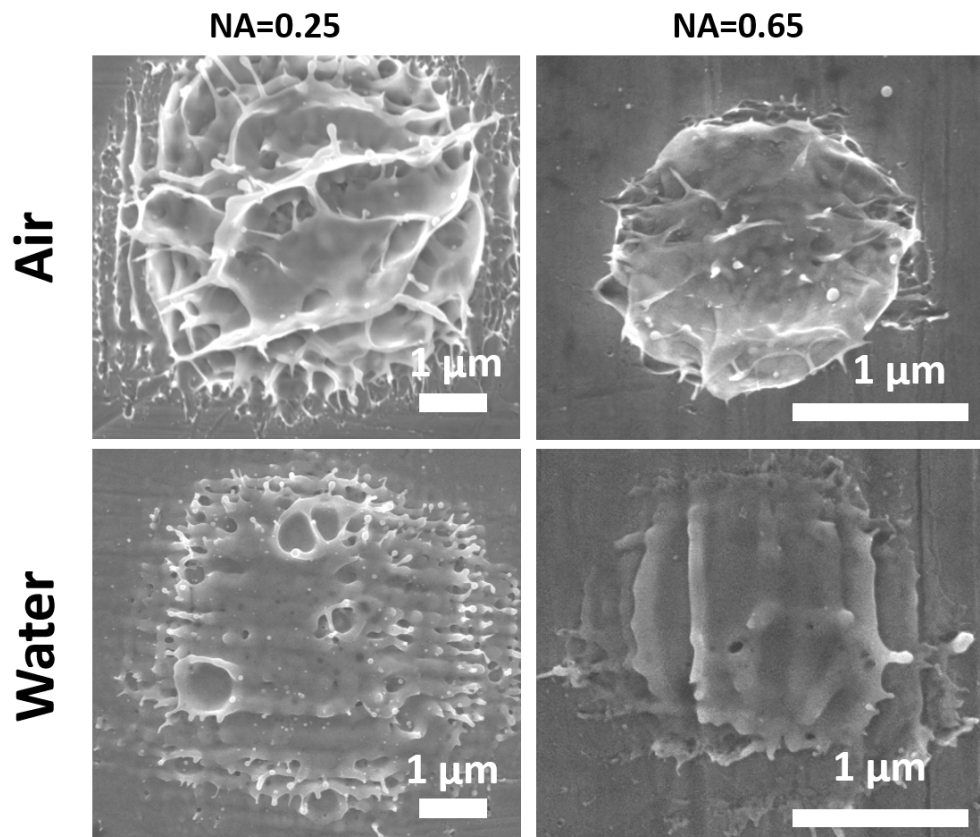

Figure 1: SEM visualization of the craters obtained in water and in air for different NA.

The fiber laser Satsuma (Amplitude Systemes) with an active medium on Yb^{+3} ions was used as the source of laser radiation (wavelength of main harmonic: 1030 nm, with frequency doubling: 515 nm, spectral full width at half-maximum (FWHM): 9 nm, repetition rate of 0-2 MHz). FWHM pulsewidth τ_p was gradually varied for IR fundamental pulses by means of an output grating

compressor over the range of 0.3-10 ps. The radiation was focused by a lens with a numerical apertures of 0.25 and 0.65 into a focal spots measuring (1 / e-diameter) 2.4 and 0.7 μm respectively. The crater profile was obtained using a scanning probe microscope. Then the dependencies of the depth of the crater on the energy density for different durations were constructed.

This work was supported by the Presidium of RAS (Program 32 “Nanostructures: physics, chemistry, biology and fundamentals of technologie“).

REFERENCES

- [1] B. Neuenschwander, B. Jaeggi, M. Schmid, G, Physics Procedia (56), 047-1058 (2014).

Femtosecond laser materials processing for defense applications: recent advances

V. R. Soma¹

Advanced Centre of Research in High Energy Materials (ACRHEM), University of Hyderabad,
Hyderabad 500046, Telangana, India
e-mail: soma_venu@uohyd.ac.in

Ultrafast (femtosecond/picosecond) laser materials processing has progressed by leaps and bounds in the last decade [1-4]. Several materials including semiconductors, metals, polymers, alloys etc. have been processed for creating microstructures/nanostructures and a variety of nanomaterials for various applications in photonics, biology, medicine etc. [1-4]. One of the major achievements of ultrafast laser material processing has been the creation of versatile nanostructures (bulk/surfaces) and nanomaterials (colloids) of plasmonic materials such as silver (Ag), gold (Au), copper (Cu), aluminum (Al) and alloys etc. [3-4]. In this presentation we will highlight some of the advances in this area for specific applications in defense. Particularly, our research group has been working on (a) femtosecond/picosecond ablation technique in liquids for creating nanoparticles/nanostructures of Ag, Au, Ag-Au, Au-Cu and their utility for trace explosives (ammonium nitrate, picric acid, RDX, HMX, NTO, TNT etc.) detection achieved using the technique of surface enhanced Raman spectroscopy (SERS) [5-11]. We have successfully created robust, versatile, cost-effective, paper-based SERS targets using the nanoparticles produced from femtosecond ablation for common explosives detection using a portable Raman spectrometer paving way for point-of-interest detection and (b) the preparation of few layered graphene (FLG) from graphite [12] using femtosecond ablation technique and formulation of nanocomposites of FLG towards applications in canister protection during missile launches. Thin, adherent, hydrophobic coating of FLG and PVA nanocomposite was produced on mild steel. The coating was able to protect the mild steel substrate on exposure to a very high temperature of 900 °C for 10s. Further, the use of laser fabricated nanoparticles in femtosecond stand-off laser induced breakdown spectroscopy for explosives detection will also be presented [13]. Several aspects of the results obtained and resulting applications from these studies will be presented.

REFERENCES

- [1] K. Sugioka, Y. Cheng, *Light: Science and Applications*, 3, e149 (2014).
- [2] A.Y. Vorobyev, C.G. Guo, *Laser & Photonics Reviews* 7(3), 385-407 (2013).
- [3] M. Malinauskas, A. Žukauskas et.al., *Light: Science and Applications*, 5, e16133 (2016).
- [4] D. Zhang, B. Gökce and S. Barcikowski, *Chem. Rev.*, 117, 3990–4103 (2017).
- [5] B. Chandu, M.S.S. Bharathi, S. Venugopal Rao, *J. Raman Spectros.*, In

Press, 2019. DOI 10.1002/jrs.5617

[6] B. Chandu, M.S.S. Bharathi, S. Venugopal Rao, *Analyst*, 144, 2327–2336 (2019).

[7] M.S.S. Bharathi, B. Chandu, S. Venugopal Rao, *RSC Advances*, 9(3), 1517-1525 (2019).

[8] M.S.S. Bharathi, B. Chandu, N.S. Sini, Ch. Bindumadhuri, S. Venugopal Rao, *ACS Omega*, 3, 8190-8201 (2018).

[9] S. Hamad, M.S.S. Bharathi et.al., *ACS Omega*, 3(12), 18420-18432 (2018).

[10] C. Byram and V.R. Soma, *Nano-Structures and Nano-Objects*, 12, 121-129 (2017).

[11] B. Chandu, M.S.S. Bharathi, S. Abdul Kalam, S. Venugopal Rao, *Chemical Physics Letters*, 685, 103-107 (2017).

[12] G. Ravi Kiran, B. Chandu, et.al., *Philosophical Magazine Letters*, 97(6), 229-234 (2017).

[13] S. Abdul Kalam, S. Venugopal Rao, *OSA Continuum*, 2(3), 554-562 (2019).

Interaction of semiconductor metasurfaces with short laser pulses: from nonlinear effects towards spatiotemporal shaping

I. Staude¹

¹ Institute of Applied Physics, Abbe Center of Photonics, Friedrich Schiller University Jena, 07745 Jena, Germany
e-mail: isabelle.staude@uni-jena.de

All-dielectric metasurfaces have been established as an efficient and versatile platform for the manipulation of light fields at the nanoscale [1]. While initial research efforts were mainly concentrated on the linear-optical properties of all-dielectric metasurfaces, they also hold a huge potential for tailoring nonlinear optical effects. Most prominently, the interaction of optically resonant semiconductor metasurfaces with intense, ultrashort laser pulses can be harnessed for enhancing and tailoring nonlinear frequency generation [2-5] and ultrafast all-optical effects [6,7]. This talk will review our recent advances in nonlinear all-dielectric metasurfaces. Furthermore, it will outline possible future research directions and application opportunities for semiconductor metasurfaces operated in conjunction with ultrashort or shaped laser pulses. In particular, the dispersive nature of the resonant metasurface response offers important opportunities to temporally shape the pulses themselves [8]. Based on this capability, we will speculate on possibilities for synthesizing arbitrary spatiotemporal light fields using specially designed metasurfaces as well as on potential application scenarios of the generated light fields.

REFERENCES

- [1] I. Staude and J. Schilling, *Nature Photon.* 11, 274 (2017).
- [2] M. R. Shcherbakov et al., *Nano Lett.* 14, 6488 (2014).
- [3] S. Liu et al., *Nano Lett.* 16, 5426 (2016).
- [4] F. J. Loechner et al., *ACS Photonics* 5, 1786 (2018).
- [5] S. Liu et al., *Nat. Commun.* 9, 2507 (2018).
- [6] M. R. Shcherbakov et al., *Nat. Commun.* 8, 17 (2017).
- [7] G. Della Valle et al., *ACS Photonics* 4, 2129 (2017).
- [8] M. Decker et al., *Adv. Opt. Mater.* 3, 813 (2015),

Femtosecond 3D processing for fabrication of functional micro and nanodevices

K. Sugioka

RIKEN Center for Advanced Photonics, Wako, Saitama, Japan;
e-mail: ksugioka@riken.jp

The extremely high peak intensity associated with ultrashort pulse width of femtosecond (fs) laser allows us to induce nonlinear multiphoton absorption with materials that are transparent to the laser wavelength. More importantly, focusing the fs laser beam inside the transparent materials confines the nonlinear interaction only within the focal volume, enabling three-dimensional (3D) micro- and nanofabrication. This 3D capability offers three different schemes, which involve undeformative, subtractive, and additive processing. The undeformative processing preforms internal refractive index modification to construct 3D optical microcomponents including optical waveguides inside transparent materials. Subtractive processing can realize the direct fabrication of 3D microfluidics, micromechanics, and photonic microcomponents in glass. Additive processing represented by two-photon polymerization (TPP) enables the fabrication of 3D micro- and nanostructures made of not only polymer but also protein for photonic, microfluidic, and biological applications. Furthermore hybrid approach of different schemes can create much more complex 3D structures and thereby promises to enhance functionality of micro- and nanodevices.

For example, a successive procedure of subtractive 3D glass micromachining and the undeformative optical waveguide writing realizes optofluidics for detection, manipulation, and sorting of bio samples [1]. Meanwhile, combination of subtractive 3D glass micromachining and additive TPP is not only an instrument that can tailor 3D structures but also a tool to fabricate biomimetic in vivo environment inside glass microfluidic chips [2]. Specifically, the subtractive 3D glass micromachining can flexibly fabricate 3D microfluidic structures embedded in glass microchips without a complicated procedure of stacking and bonding of glass substrates. Successive TPP can then integrate complex shapes of polymer structures with a sub-micrometer feature size due to its high fabrication resolution to create biomimetic structures inside the glass microfluidics. Thus, such advanced biochips can be utilized to study the mechanism of cancer cell invasion and metastasis [3]. Furthermore, the subtractive 3D glass micromachining followed by femtosecond laser direct write ablation and successive electroless metal plating enables selective metallization of 3D glass microfluidic chips for electrical control of living cell movement in 3D [4]. This selective metallization technique is also applied to fabricate 3D microfluidic surface-enhanced Raman spectroscopy (SERS) sensors with an extremely high enhancement factor by formation of periodic nanodot structures on the plated metal thin films [5].

This talk presents our recent achievements on fabrication of functional 3D micro- and nanosystems including microfluidics, optofluidics, microsensors, and 3D proteinaceous microstructures by femtosecond laser 3D processing.

REFERENCES

- [1] K. Sugioka, Y. Hanada, and K. Midorikawa, *Laser Photon. Rev.* 3, 386-400 (2010).
- [2] D. Wu, J. Xu, et. al. *Light Sci. Appl.* 4, e228 (2015).
- [3] F. Sima, H. Kawano, et. al. , *ACS Appl. Bio Mater.* 1, 1667-1676 (2018).
- [4] J. Xu, H. Kawano et.al., *Microsystems Nanoengin.* 3, 16078 (2017).
- [5] S. Bai, D. Serien, A. Hu, and K. Sugioka, *Adv. Func. Mater.* 28, 1706262 (2018).

Features of modification of structural-phase state of titanium alloys under irradiation with short and ultrashort laser pulses

Yu. R. Kolobov^{1,2}, A. Yu. Tokmacheva-Kolobova^{1,3}, S. S. Manokhin¹,
A. A. Ionin⁴, S. I. Kudryashov⁴, G. V. Odintsova⁵ and V. P. Veiko⁵

¹ Institute of Problems of Chemical Physics RAS, Chernogolovka, Russia

² Belgorod National Research University, Belgorod, Russia

³ National University of Science and Technology "MISIS", Moscow, Russia

⁴ Lebedev Physical Institute of the RAS, Moscow, Russia

⁵ ITMO University, Saint Petersburg, Russia

e-mail: kolobov@icp.ac.ru

The report provides an overview of the main results of the author's original works on the study of changes in the structure and properties of the surface and surface layers of titanium and alloys based on it as a result of irradiation with short (nanosecond) and ultrashort (femtosecond) laser pulses.

The regularities of the formation of multiscale surface relief with micro- and nano-roughness and associated with this unique properties of the surface, such as superhydrophilicity and superhydrophobicity [1]. The features of the effect of increasing the fatigue resistance and increasing plasticity after femtosecond laser irradiation established on the example of thin plates of submicrocrystalline technically pure titanium (alloy VT1-0) are discussed [2].

The analysis of regularities and physical causes of the detected (by the example of femtosecond irradiation of Ti-6Al-4V alloy) nanostructuring effect of a thin (about 1 μm thick) near-surface layer [3] is carried out. It is assumed that this effect is associated with the excitation of shock waves of the megabar level in these processing conditions [4, 5].

The study was carried out with the financial support of the Thematic Map of fundamental research of the Institute of Problems of Chemical Physics of RAS No. 0089-2019-0017.

REFERENCES

- [1] Kudryashov S., Kolobov Yu., Ligachev A., *Photonics* 3 (45), 14-22 (2014).
- [2] Kolobov Yu. R. et al., *Technical Physics* 63(3), 385-390 (2018).
- [3] Kolobov Yu. R., Golosov E. V., Vershinina T. N.: Kolobov Y. R., *Applied Physics A*. 119 (1), 241-247 (2015).
- [4] A.A. Ionin et al., *JETP Lett.* 94 (1), 34-38 (2011).
- [5] E. I. Ageev et al., *JETP Lett.* 102 (10), 35-39 (2015).

On the possibility of overcoming the diffraction limit with self-assembly of nanostructures controlled by quasi-resonant laser radiation

A. S. Tsipotan¹, V. V. Slabko¹

¹ Siberian Federal University, Krasnoyarsk, Russia;

e-mail: acipotan@sfu-kras.ru

In recent decades, nanostructures with unique properties other than properties of a bulk sample and dependent on both composition and shape have been studying actively. Therefore, the problem of developing a universal method of nanostructures formation is a subject of interest of many scientists. The least expensive method of obtaining colloidal crystals, which doesn't require a local physical impact on the system, is based on the ability of nanoparticles to self-organize in the process of random Brownian collisions in real disperse systems [1, 2]. However, in such case it is impossible to control the processes of formation of nanostructures with predetermined shapes. Therefore, one of the possible solutions of this problem is the physical impact on the ensembles of nanoparticles that allows the formation of complex nanostructures without additional surface modifications [3, 4]. However, it isn't always possible to achieve the selectivity of the self-assembly process.

Earlier in [5, 6], it was shown that the interaction of resonant nanoparticles in the field of laser radiation makes possible the formation of predetermined structures, since the energy of the induced dipole-dipole interaction is sufficient to overcome the barrier that prevents spontaneous aggregation (which makes possible the formation a stable structure), and their geometry depends on the wavelength and the polarization of the external field. In this case, the formation of structures, which scale is much smaller than the wavelength of the laser radiation caused this polarization, becomes possible. The presence of optical resonances in the particle leads to an increase of the interparticle interaction and is the basis for the selective formation of different structures with a predetermined position of the particles in the aggregate. It becomes possible because the energy of the interparticle interaction in the laser radiation field depends on its frequency, the resonance frequencies of the particles, and on the orientation of their group relatively to the plane of polarization. Here we report the experimental evidence for laser-induced self-assembly of CdTe QDs illuminated by a sequence of nanosecond laser pulses resulting in formation of stable QD pairs.

REFERENCES

- [1] T. Wang, D. Lamontagne, J. Lynch, J. Zhuang, Y.C. Cao, *Chem Soc Rev.* 42(7), 2804-2823 (2013).
- [2] L. Qingqing, C. Baoliang, X. Baoshan, *Environmental Science & Technology* 51(3), 1364-1376 (2017).

-
- [3] J. Gong, G. Li, Z. Tang, *Nano Today* 7(6), 564-585 (2012).
 - [4] S. Srivastava, A. Santos, K. Critchley, *Science* 327(5971), 1355-1359 (2010).
 - [5] A.S. Tsipotan, M.A. Gerasimova, V.V. Slabko, A.S. Aleksandrovsky, *Opt. Express* 24(10), 11145-11150 (2016).
 - [6] V.S. Kornienko, A.S. Tsipotan, V.V. Slabko, *Journal of Siberian Federal University. Mathematics & Physics* 11(6), 1-10 (2018).

Femtosecond optical investigation of the acoustic response of metal nanoparticles: from macro- to nano-size mechanical resonators

N. Del Fatti, A. Crut, P. Maioli and F. Vallee

FemtoNanoOptics Group ILM, CNRS - Université Lyon 1, France
e-mail: fabrice.vallee@univ-lyon1.fr

Controlling and modeling the mechanical response of nanoscale systems is of central interest for many technological applications. In this size range, breaking of translational invariance leads to appearance of discrete acoustic modes of key importance for applications as they rule many fundamental properties of nano-materials. They have been intensively studied during the last decade as their description raises fundamental questions and full exploitation of the new potentialities they offer requires identifying and understanding the underlying physical mechanisms at the origin of their specific responses.

The acoustic mode frequencies of nano-objects down to the one nanometer size are well described in the framework of the elasticity model, identifying the nano-object to a nano-resonator [1]. For smaller sizes, deviations are experimentally observed suggesting description of the vibrational modes should be performed with atomistic models rather than with the elastic body one (i.e., using macroscopic elastic model). Using optical time-resolved spectroscopy, we show that this two approaches yield similar results down to the one nanometer scale, provided the environment of the nano-objects is properly taken into account [2].

Acoustic vibration damping mostly originates from vibrational energy transfer from the objects to their environment, making it highly sensitive to their mechanical contact, to the presence of interfacial layers, and to the object morphology. This sensitivity makes theoretical description challenging but also opens-up the possibility of altering the damping of a given acoustic mode. This can be done by reducing the associated surface displacement, i.e., localizing the displacement field in the particle core, properly adjusting the particle geometry [3]. These dependencies will be discussed, based on experimental investigations of the acoustic vibration of single supported metal nano-objects.

REFERENCES

- [1] A. Crut et al., *Chem. Soc. Rev.* 43, 3921 (2014)
- [2] P. Maioli et al., *NanoLetters* 18, 6842 (2018)
- [3] F. Medeghini et al., *NanoLetters* 18, 5159 (2018)

Refractive index mapping with plasmonic nanoantenna

S. O. Gurbatov, A. A. Kuchmizhak and O. B. Vitrik

Institute for Automation and Control Processes FEB RAS.
e-mail: oleg_vitrik@mail.ru

As the size of the state-of-the-art optical devices shrinks to nanoscale, the need for tools allowing mapping the local optical properties at deep sub-diffraction resolution increases. Here we demonstrate successful mapping the variations of the refractive index (RI) of a dielectric surface by detecting resonant wavelength shift of a single spherical-shape Ag nanoparticle optically aligned with a supporting optical fiber axicon microlens. The ability to map the refractive index of non-smooth surfaces in the constant height mode by additionally controlling the scattering intensity is demonstrated. We propose and examine various excitation schemes of the plasmonic nanoantenna to provide efficient interaction of its dipolar and quadrupolar modes with the underlying sample surface and to optimize the mapping resolution and sensitivity. Moreover, we demonstrate a lithography-free approach for fabrication of the scanning probe combining the high-quality fiber microaxicon with the Ag spherical nanoparticle atop. Supporting finite-difference time-domain calculations are undertaken to tailor the interaction of the plasmonic nanoantenna and the underlying dielectric substrate upon various excitation conditions demonstrating good agreement with our experimental findings and explaining the obtained results.

Femtosecond laser-induced nanomodification and ripple formation at amorphous silicon surfaces

S. V. Zobotnov, D. V. Shuleiko, M. N. Martyshov, D. V. Orlov, D. E. Presnov, A. G. Kazanskii and P. K. Kashkarov

Lomonosov Moscow State University, Faculty of Physics, Moscow, Russia
e-mail: zobotnov@physics.msu.ru

Direct laser writing is an effective technique to fabricate surface structures with wavelength and subwavelength accuracy. One of realizations of such approach is the laser-induced periodic surface structure (LIPSS) formation via femtosecond laser irradiation where intensive surface photoexcitation results to surface plasmon-polariton generation not only in metals but also in semiconductors due to electron-hole plasma generation [1, 2]. Such surface electromagnetic waves give a contribution to the periodical relief modulation and corresponding ripple formation at the irradiated surfaces.

The present work describes main features of the LIPSS formation at amorphous silicon surfaces under femtosecond laser action when the pulses number (50 – 1000) and laser wavelength (417, 625, 1250 nm) are varied. These parameters combination allows to fabricate ripples with the period from 125 to 1250 nm and the orientation perpendicular or parallel relative to the laser radiation polarization. To explain such evolution, we used the model proposed by J.E. Sipe where so-called efficacy factor depends on the real and imaginary parts of the dielectric constant and defines the LIPSS wave vector on the irradiated surface [3, 4]. In turn, the dielectric constant complex value is varied due to concentration change for the nonequilibrium electrons excited by different number of high-power femtosecond laser pulses.

The modified surfaces are characterized by the high level of nanocrystallization. According to Raman spectra analysis the volume fraction of nanocrystals in the irradiated films ranges from 40% to 70% depending on the treatment conditions. The silicon nanocrystal presence leads to growth of the specific conductivity up to 3 orders for the irradiated samples in comparison with non-irradiated ones. The in-plane conductivity anisotropy was revealed also. The specific conductivity along the ripples twofold – threefold exceeds this value for the perpendicular reciprocal orientation of the applied current and ripples. This result is in a good agreement with the Bruggeman model [5] for the surface possessing form anisotropy.

Thus, the amorphous silicon films modified by femtosecond laser pulses possess the valid in-plane anisotropy and are promising for design of new devices for electronics and photovoltaics.

D.V.S., M.N.M. and D.V.O. are grateful to the Russian Foundation for Basic Research for financial support (project 19-32-70026).

REFERENCES

- [1] K. Sokolowski-Tinten, D. von der Linde, *Phys. Rev. B* 61(4), 2643 (2000).
- [2] D. V. Shuleiko, F. V. Potemkin, I. A. Romanov, et al., *Las. Phys. Lett.* 15(5), 056001 (2018).
- [3] J. E. Sipe, J. F. Young, J. S. Preston, and H. M. van Driel, *Phys. Rev. B* 27(2), 1141 (1983).
- [4] J. Bonse, M. Munz, H. Sturm, *J. Appl. Phys.* 97, 013538 (2005).
- [5] A. K. Sarychev, V. M. Shalaev, *Electrodynamics of Metamaterials*, Singapore: World Scientific (2007).

Sub-kilometer-per-second laser scanning by polygon systems for high-throughput laser microprocessing

D. A. Zayarny¹, S. I. Kudryashov¹, A. A. Nastulyavichus¹ and A. A. Ionin¹

¹ P.N. Lebedev Physical Institute of the Russian Academy of Sciences, Moscow, Russia
e-mail: dzayarny@sci.lebedev.ru

An experimental laser marker setup with a polygon mirror is presented, which allows the processing of samples with a Satsuma femtosecond laser to form arbitrarily given raster two-dimensional microstructures on their surface with a maximum scanning speed of up to 1000 m/s.

Light manipulation by dielectric nanoparticles produced by femtosecond laser printing

D. M. Zhigunov

Center for Photonics and Quantum Materials, Skolkovo Institute of Science and Technology,
Bolshoy Boulevard 30, bld. 1, 121205 Moscow, Russia
e-mail: d.zhigunov@skoltech.ru

We present our recent results on fabrication and optical characterization of dielectric Si and Ge-based nanoparticles produced by means of femtosecond laser-induced forward transfer method. This method is called also femtosecond laser printing approach, as soon as a single nanoparticle is produced by a single laser pulse, owning an advantage of precise control of the nanoparticle size and position on a receiver substrate. Nanoparticle arrays with controlled size and inter-particle distance are the promising artificial objects for light manipulation at the nanoscale, i.e. for the construction of desired optical response to the given excitation. Nanoparticles with the diameter of about 200-300 nm were produced and studied by scanning electron microscopy and optical spectroscopy methods. Raman spectroscopy revealed the crystalline structure of as-fabricated nanoparticles. Experimental light-scattering spectra of single nanoparticles show characteristic Mie-type resonances, which positions are determined by the size and shape of nanoparticles, as confirmed by numerical simulations using Mie theory. Second harmonic generation as well as broadband multiphoton-induced luminescence from both Si and Ge nanoparticles were observed under 800 nm femtosecond laser excitation. The effect of post-treatment of as-prepared nanoparticles by femtosecond laser irradiation on their optical properties is discussed.

Femtosecond laser processing and assembly of nanostructures and nanodevices

Y. Norman Zhou

Waterloo Institute of Nanotechnology, Centre for Advanced Materials Joining, University of Waterloo, Waterloo, Canada
e-mail: nzhou@uwaterloo.ca

Nanomaterials such as nanoparticles and nanowires represent an important group of building blocks for bottom-up fabrication of electronic components and devices. On the other hand, ultrafast lasers have recently become very popular for use in processing and joining of nanomaterials because of the advantages such as ultra-high peak power and minimal damage to the nano-objects.

This presentation will review recent progress and challenges in femtosecond (fs) laser processing and assembly of nanostructures and nanodevices based on the literature and especially our recent work. Examples will be provided to cover process fundamentals, such as the effect of process parameters (e.g., gap and angle between nanowires) on localized heating [1,2], gap bridging and bonding mechanisms [3], and metal-semiconductor heterojunctions [4]. Case studies will be also included to illustrate the potential applications of fs-laser processed nanostructures and nanodevices, e.g., TiO₂/Au two-terminal nanowire devices for resistive switching memory [5] and Ag nanoparticle structures for surface enhanced Raman spectroscopy [6].

REFERENCES

- [1] L. Lin, et al., *Nanotechnology*, 27, 2016, 125201
- [2] S. Xing, et al., *ACS Appl. Mater. Interfaces*, 11(9), 2019, 9326-9332
- [3] L. Liu, et al., *Nano-Micro Lett.*, 5(2), 2013, 88-92
- [4] L. Lin, et al., *Appl. Phys. Lett.*, 108, 2016, 203107
- [5] L. Lin, et al., *Adv. Funct. Mater.*, 26, 2016, 5979-5986
- [6] H. Huang, et al., *J. Appl. Phys.* 112(12), 2012, 123519

3D photonic wirebonds as modern basis for integrated optics

R. D. Zvagelsky^{1,2}, D. A. Chubich², D. A. Kolymagin², A. V. Pisarenko² and
A. G. Vitukhnovsky^{1,2}

¹ Lebedev Physical Institute, Russian Academy of Sciences, Moscow, Russia;

² Moscow Institute of Physics and Technology (State University), Dolgoprudny, Russia;

e-mail: superznatok@gmail.com

Daily used electronic circuits provide limited bandwidth for transmission of signal due to electromagnetic interference. It comes to the aid conception of photonic wirebond chip interconnection [1], which offer low-loss signal transmission with bandwidths up to several Tbit/s.

However, the concept of nanophotonic integrated circuits requires complex lithographic systems, which can fabricate structures in three dimensions on micron and even nanoscale. In recent years, direct laser writing (DLW), the method of advanced optical lithography based on femtosecond two-photon absorption gained popularity. With DLW systems it is possible to fabricate photonic nanostructures with desired three-dimensional geometry [2].

We printed several arrays of bridge-shaped photonic polymeric wirebonds with different heights, widths, lengths, and radii of curvature on commercial DLW system Nanoscribe Photonic Professional with IP-Dip photoresist (Nanoscribe, GmbH). For the best light passing we chose Gaussian function as curve describing beginning of wirebond and arc as its continuation (fig. 1). To test transmission properties of fabricated structures the waveguide (silicon nitride) with grating couplers for light entering were used. Such waveguide supports two guided modes (TE- and TM-like) at a wavelength of 1550 nm and effectively drives the radiation into the polymeric wirebond.

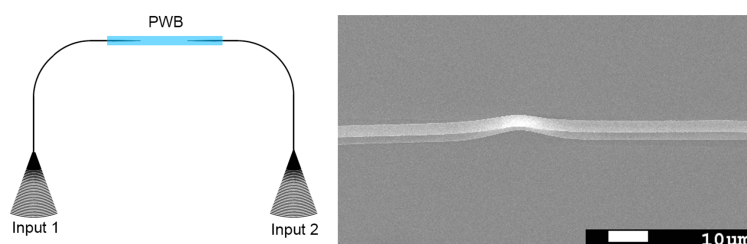

Figure 1: The example of the image.

The authors are grateful to MIPT Shared Facilities Centre, financial support was granted by the RSF project no. 17-79-20418 (fabrication) and RFBR project no. 18-29-20129 (inspection).

REFERENCES

- [1] M. Schumann et al., *Light: Science & Applications* (3), e175 (2014).
- [2] D. A. Chubich et al., *AIP Conf. Proc.* (2064), 030002 (2019).

Section 4: Femtosecond non-linear optics. Filamentation. High field THz generation.

Section Chair:

Leonid Seleznev, e-mail: seleznev@lebedev.ru
(Lebedev Physical Institute, Russia)

Program committee:

Alexander Shkurinov
(Moscow State University, Russia)

Alexander Zemlyanov
(Zuev Institute of Atmospheric Optics, Russia)

Vladimir Fedorov
(Texas A&M University at Qatar, Qatar)

Olga Kosareva
(Moscow State University, Russia)

Scope

Self-compression and self-focusing

Terahertz science

Filamentation in various media

High-field nonlinear phenomena

Experimental study of leader propagation in air into a nanosecond laser filament channel of 1-m scale under the Tesla created HV pulse.

L. Arantchouk, A. Mysyrowicz and A. Houard

Laboratoire d'Optique Appliquée - ENSTA ParisTech, Ecole Polytechnique, CNRS - 91761
Palaiseau, France
e-mail: leonid.arantchouk@ensta-paristech.fr

A 200-mJ, 700-fs laser beam [1] generates a bundle of plasma filaments touching the HV electrode of a Tesla generator. The Tesla pulse with maximal amplitude of 300 kV [2] generates a breakdown between two electrodes separated by 100-115 cm. We study the development of the discharge in the presence of laser filaments using a high-speed camera.

In the two-electrode geometry a delay between the laser beam generation and breakdown varies in the range of 18-20 us. During this delay a laser-guided leader is born on HV electrode and propagates along the plasma filaments produced by the laser pulse. The breakdown happens as soon as the leader touches the ground electrode. We observe a bright spark just at this moment, when the electrical charge of the leader has carried the high potential to the ground. The leader development is accompanied by numerous lateral streamers manifesting this high potential distributed along the progressing guided discharge channel.

Progressing of the leader initiated by the Tesla high voltage potential has a stepped way character. Its velocity varies during the propagation in the range 25 - 100 km/s.

REFERENCES

- [1] G. Point, Y. Brelet, A. Houard, V. Jukna, C. Milián, J. Carbonnel, Y. Liu, A. Couairon, and A. Mysyrowicz, Phys. Rev. Lett. 112, 223902 (2014)
- [2] L. Arantchouk, G. Point, Y. Brelet, B. Prade, Y.-B. André, A. Mysyrowicz, and A. Houard, J. Appl. Phys. 116,013303 (2014)

Ultrafast spectroscopy of air lasing

L. Arissian^{1,2,3}, B. Kamer¹ and J. C. Diels¹ and A. Rastegari¹

¹ University of New Mexico, Albuquerque, USA;

² University of Ottawa, Ottawa, Canada;

³ National Research Council of Canada, Ottawa, Canada

e-mail: ladan@unm.edu

Generation and control of a narrow line source in atmosphere is of great interest for atmospheric studies and remote sensing. Nonlinear propagation of ultrashort pulses in a wide wavelength range from ultraviolet to infrared had resulted in "light filaments" that can harness intensities in the order of 10^{14} Watt/cm². The high intensity region has typical cross section of 200 micron and the length of a meter with mJ energy using 800 nm ultrashort pulses while using 266 nm long pulses of 200 picosecond the filament strings are measured to be 10 to 40 meters long and can carry several joules. Recently there had been a great interest to control and understand the narrow line emission of N_2^+ in light filaments. The high gain cavity less emission is known as "air lasing" [1].

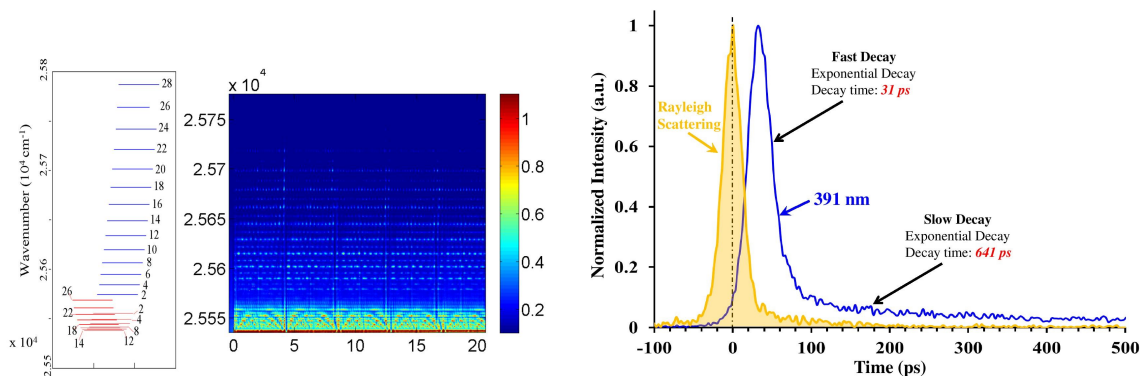

Figure 1: Left) High resolution spectroscopy of air lasing resolving rotational lines in "P" (red) and "R" (blue) branch of $B^2\Sigma_u^+$ to $(X^2\Sigma_g^+ \nu = 0 \ \& \ \nu = 0)$. The time axis corresponds to the delay of 400 nm seed pulses with respect to 800 nm ionizing pulse in pure nitrogen at 1 atm. Each vertical line in the 2D image presents the observed rotational line at the set delay. The integration time to capture the spectrum is orders of magnitude longer than the life time of the emission. This observation suggests that rotational dynamics in the N_2^+ has a great influence on the measured gain. No emission is recorded in the absence of the seed. Right) Time resolved emission of fluorescence from the same transition using Streak camera.

In this paper we present the results of our various investigation methods to understand the gain mechanism of N_2^+ . Using high resolution spectroscopy in a pump-probe setting in which an ultrashort mJ 800 pulse is followed by a 400 nm ultrashort weak probe, the gain in rotational lines of $f B^2\Sigma_u^+$ to $(X^2\Sigma_g^+ \nu = 0 \ \& \ \nu = 0)$ at 391 nm is measured as shown in Figure 1(left). The gain can be induced with delays up to 100 picosecond, however the coherence dynamics due to rotational wavepacket in N_2^+ is replaced with rotational dynamic in neutral molecule for delays longer than 30 picoseconds. The mechanism of fast and slow

gain [3] and the stark shift induced by plasma dynamics [4] are all evidences of a high gain due to superradiance.

In order to directly measure the time dependent emission of N_2^+ , the side emission from 30 mJ focused ultrashort pulse at 800 nm is captured using a streak camera. The air lasing is delayed with respect to the Rayleigh scattering of 800 nm beam and the fast gain decays at 30 picosecond with a low gain that lasts up to 600-700 picoseconds. The analysis of emission from different portions of plasma confirms that the delay in emission is inversely proportional to the gain suggesting the contribution of collective emission in observed high gain in the "air lasing".

REFERENCES

- [1] Q. Luo, A. Hosseini, W. Liu, and S. L. Chin, *Optics & Photonics News* 15(9), 44-47 (2004).
- [2] L. Arissian, B. Kamer, A. Rastegari, D. M. Villeneuve, and J-C Diels, *Phys. Rev. A* 98, 053438 (2018)..
- [3] M. Britton, M. Lytova, P. Laferrière, P. Peng, F. Morales, D. H Ko, M. Richter, P. Polynkin, D. M. Villeneuve, C. Zhang, M. Ivanov, Michael Spanner, L. Arissian, and P. B. Corkum, *Phys. Rev. A* 100, 013406 (2019).
- [4] L. Arissian, B. Kamer, and J. C. Diels, in *Conference on Lasers and Electro-Optics*, OSA Technical Digest (Optical Society of America, 2019), paper FTh1M.4.

THz radiation in circularly-polarized multicolor strong fields

I. Babushkin^{1,2,3}

¹ Institute of Quantum Optics, Leibniz University, Welfengarten 1, 30167 Hannover, Germany

² Cluster of Excellence PhoenixD (Photonics, Optics, and Engineering – Innovation Across Disciplines), Hannover, Germany

³ Max Born Institute, Max Born Str. 2a, 12489 Berlin, Germany

e-mail: babushkin@iqo.uni-hannover.de

Terahertz (THz) frequencies lie at the long-wavelength limit of optical range (wavelengths around 100 μm) and are extremely useful for many applications, mostly biological ones, since transitions between rotational and vibrational levels of complex molecules lie in this range [1].

One of the useful methods to generate THz pulses is based on ionization of noble gases in two color pulses [1-4]. Noble gases possess smaller nonlinearities, but they are fully transparent down to 100 nm wavelength. A typical setup exploiting two-color pump pulses is rather simple: a linearly polarized pulse of the fundamental frequency and its second harmonic are focused into a random spot, causing light-induced plasma. In this plasma, a low frequency signal with an electric field up to several hundreds kV/cm is generated. At high pump intensities, THz radiation is produced by ionization in an asymmetric pump field and the subsequent dynamics of asymmetric plasma current arising due to the gas photo-ionization [5]. Another nonlinearity originating from non-resonant atomic response ($\chi^{(3)}$ -nonlinearity) plays only a minor role.

In this simple setup, a search for optimal waveshapes providing highest THz emission was made. In particular, in [6-8] it was shown that the multicolor pulses provide more efficiency in THz generation than two color ones. Finally, recent research showed [9-10] that in two-color circular fields THz generation is also around one order of magnitude more efficient. In this talk we provide analysis of the optimality of THz emission with two- and multi-color driver fields of arbitrary ellipticity and derive the maximum efficiency conditions for different geometries.

Another application of the circular polarized THz pulses we consider here is the ability to get the information about attosecond-long delays of electrons by tunneling ionization. Dynamics of optical tunneling is one of the central topics of attosecond science. The most prominent method to access attosecond-long delays in course of electron ionization is known as attoclock [11,12]. In the attoclock procedure, electrons ionized by a nearly-circularly polarized optical field are detected by a remote detector. The electric field of the driver pulse plays a role of a clock hand rotating with the optical frequency. Ionization delays lead to an angular shift of the electronic distribution at the detector. However, to access ionization dynamics one needs to “unwind” the electron path from the detector back to the core [13], making the physical insight rather cumbersome.

Here we propose to access the attoclock information in a fully optical way [14], looking at the THz radiation. Despite the light in the THz range has a picosecond oscillation period, here we show that the attosecond-scale delays are well-visible in the polarization of such THz harmonic.

To excite the THz harmonic we use a two-color circularly polarized co-rotating fields with some fundamental frequency ω and its second harmonic. For such a driver, the THz harmonic is linearly polarized. In the presence of ionization delays τ the polarization of the THz harmonic is rotated by the angle $\omega\tau$ in respect to the case of $\omega\tau = 0$ (this reference direction is fully determined by the driver waveshape). That is, we obtain an “optical attoclock“ where the hand of the clock is the polarization of the THz radiation.

REFERENCES

- [1] K. Reimann, Rep. Progr. Phys. **70**, 1597 (2007).
- [2] D. J. Cook and R. M. Hochstrasser, Opt. Lett. **25**, 1210 (2000).
- [3] T. Bartel, *et al.*, Opt. Lett. **30**, 2805 (2005).
- [4] M. Kress, *et al.*, Opt. Lett. **29**, 1120 (2004).
- [5] K. Kim, J. Glowonia, A. Taylor, and G. Rodriguez, Nat. Photon., **2**, 605 (2008).
- [6] P. González de Alaiza Martínez, *et al.*, Phys. Rev. Lett, **114**, 183901 (2015).
- [7] I. Babushkin, *et al.*, New J. Phys., **13**, 123029 (2011).
- [8] V. Vaičaitis, *et al.*, J. Appl. Phys. **125**, 173103 (2019).
- [9] V. A. Tulskey, *et al.*, Phys. Rev. A, **98**, 053415 (2018).
- [10] Y Huang, *et al.*, Appl. Phys. Lett. **109**, 131105 (2016).
- [11] P. Eckle, *et al.*, Nat. Phys. **4**, 565 (2008).
- [12] L. Torlina, *et al.*, Nat. Phys. **11**, 503 (2015).
- [13] H. Ni, U. Saalman, and J.-M. Rost, Phys. Rev. Lett. **117**, 023002 (2016).
- [14] I. Babushkin, *et al.*, ArXiv e-prints:1803.04187 (2018).

Supercontinuum generation under axicon focusing of femtosecond wave packet

S. V. Chekalin¹, V. O. Kompanets¹, E. D. Zaloznaya², A. E. Dormidonov¹,
V. P. Kandidov²

¹ Institute for Spectroscopy RAS, Troitsk, Moscow, Russia;

² Faculty of Physics, M.V. Lomonosov Moscow State University, Moscow, Russia;

e-mail: ed.zaloznaya@physics.msu.ru

The formation of a filament and a light bullet in a femtosecond wave packet focused by the axicon under conditions of anomalous group velocity dispersion occurs simultaneously with the formation of a Bessel-Gaussian structure. In the case of a sharp axicon focusing the light bullet forms in a central lobe of a Bessel-Gaussian intensity distribution (figure 1a). In the case of a weak focusing - nonlinear compression of a wave packet dominates over axicon focusing and the formation of a light bullet is similar to the case of an initially Gaussian beam (figure 1b). The intensity of light bullets in both cases is around 55 TW/cm^2 , their duration is about $1 \div 2$ periods of optical oscillations. And the distance before the light bullet formation is smaller under sharp focusing.

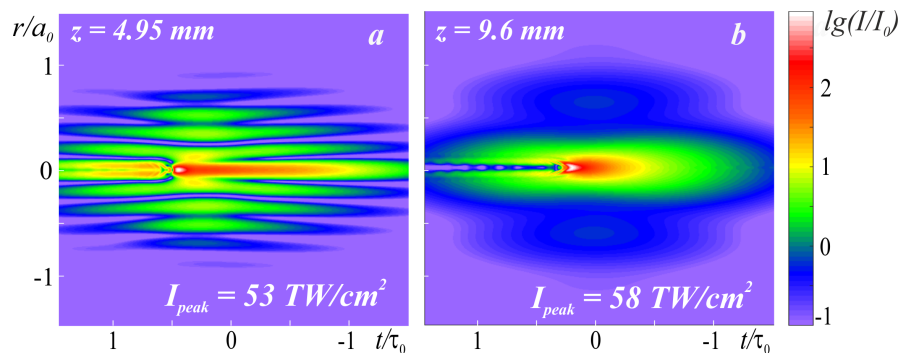

Figure 1: Spatiotemporal intensity distributions $I(r,t)$ for the wave packets with the peak energy $3\mu\text{J}$ at the wavelength 1900 nm in SiO_2 . Sharp focusing with the axicon angle 5° (a); weak focusing with the angle of 1° (b).

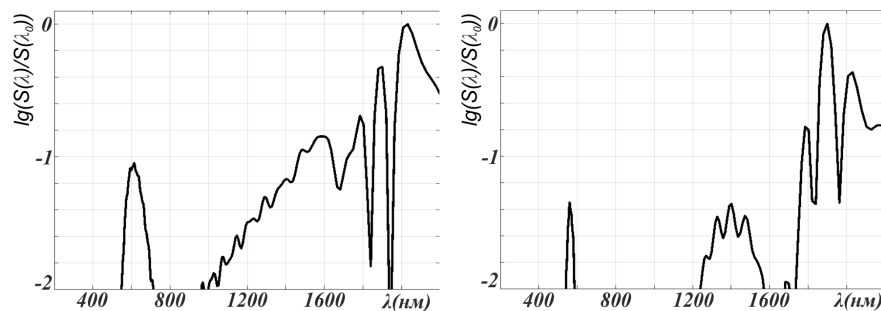

Figure 2: Light bullets spectrum at the distances where the anti-Stokes spectral component reaches its maximum. Sharp focusing (a); weak focusing (b).

At that, spectrum broadening in the anti-Stokes region during light bullet formation is greater in the case of sharp focusing. However, when light bullet propagates over several hundreds of microns a narrow isolated anti-Stokes wing forms, and its short-wavelength cut-off does not depend on the focusing sharpness (figure 2).

The work was supported by the Russian Science Foundation (Project N 18-12-00422).

Terahertz generation in long two-color air filaments

P. A. Chizhov¹, A. A. Ushakov^{1,2}, V. V. Bukin¹ and S. V. Garnov¹

¹ Prokhorov General Physics Institute of the Russian Academy of Sciences, Moscow, Russia;

² Lomonosov Moscow State University, Moscow, Russia;

e-mail: pvch@inbox.ru

Terahertz (THz) generation in gas plasma is attracting a lot of attention due to broad spectrum of generated pulses and ability to use high-energy laser pumping [1]. The most effective way to generate THz radiation in gas plasma is to use two-color femtosecond pulses [2]. In this case the mutual phase difference between harmonics governs the efficiency of optical-to-terahertz conversion [3]. In atmospheric air the π phase walk-off between fundamental and second harmonic constituents of two-color pulse of Ti:Sapphire laser appears at a distance about 25 mm [3]. For long filaments this phase difference is changing along the plasma channel. As shown previously, this effect leads to off-axis peak in spatial THz distribution [4] and to possibility of waveform control by initial phase mismatch adjustment between harmonics [5]. One can model THz generation in the filament considering plasma as a set of local emitters (dipoles) [4-6].

In our work we investigate experimentally THz generation in two-color femtosecond filaments with lengths up to 100 mm. For such lengths the effect of interference between areas along the channel with different phase mismatch between harmonics should be more drastic. We demonstrate strong effect of phase matching on THz emission and provide screening by a metallic diaphragm of a part of the emission leading to increase in the detected power up to 20% of that for undisturbed emission. It is also demonstrated that temporal overlapping of constituents of the two-color pulse plays an important role in the THz generation process. For the case of group delay compensation between fundamental and second harmonics the length of effective THz generation increases. We also show the spectral modulation (filtering) by means of π -retarder screens for a distinct THz frequency or by use of axicon PTFE-lenses.

REFERENCES

- [1] X.-C. Zhang, A. Shkurinov, Y. Zhang, *Nature Photonics* 11 (1), 16 (2017)
- [2] D. J. Cook, R. M. Hochstrasser, *Opt. Lett.* 25 (18), 1210 (2000)
- [3] M. Kress, T. Löffler, S. Eden, M. Thomson and H. Roskos, *Opt. Lett.* 29 (10), 1120 (2004)
- [4] Y. S. You, T. I. Oh, and K. Y. Kim, *Phys. Rev. Lett.* 109 (18), 183902 (2012)
- [5] A. Gorodetsky, A. D. Koulouklidis, M. Massaouti and S. Tzortzakis, *Phys. Rev. A* 89 (3), 033838 (2014)
- [6] Z. Zhang, Y. Chen, M. Chen, Z. Zhang, J. Yu, Z. Sheng and J. Zhang, *Phys. Rev. Lett.* 117 (24), 243901 (2016)

Hollow-Core Antiresonance-Guiding Photonic Crystal Fiber for Multioctave Supercontinua Generation in Mid-Infrared

A. B. Fedotov^{1,2}, E. A. Stepanov^{1,2}, A. A. Voronin^{1,2}, F. Meng⁴,
A. V. Mitrofanov^{1,2,5,6}, D. A. Sidorov-Biryukov^{1,2,5}, Y. Li⁴, M. Hu⁴, and
A. M. Zheltikov^{1,2,3,5}

¹ Physics Department, International Laser Center, M.V. Lomonosov Moscow State University, Moscow, Russia;

² Russian Quantum Center, Skolkovo, Moscow Region, Russia;

³ Department of Physics and Astronomy, Texas A&M University, College Station, USA

⁴ Ultrafast Laser Laboratory, Tianjin University, Tianjin, China

⁵ Kurchatov Institute National Research Center, Moscow, Russia

⁶ Institute of Laser and Information Technologies, Shatura, Moscow Region, Russia

e-mail: a.b.fedotov@physics.msu.ru

Multioctave supercontinuum generation is a unique tool for ultrafast optical science, providing ultrabroadband frequency-comb technologies and generation of extremely short (even subcycle) laser pulses. Shifting of these methods to the mid-infrared spectral range is challenging as it calls for new fiber solutions that would allow a high optical nonlinearity in the mid-IR to be combined with broadband transmission and suitably tailored dispersion. Kagome-cladding and antiresonance-guiding single-ring (SR) hollow-core (HC) photonic-crystal fibers stand out as examples of fiber designs that can provide this unique combination of properties [1-4].

In our experiments, ultrashort mid-IR pulses were used to drive supercontinuum generation in a gas-filled SR HC PCF. The antiresonance-guiding ring structure in this fiber is designed in such a way as to support soliton selfcompression of the mid-IR driver to pulse widths well below the field cycle. A solitonic transformation of a 3.2- μm , sub-200-fs output of a multistage optical parametric amplifier in such a fiber yields multioctave supercontinua spanning from 0.3 to 5.2 μm . The spectra of the hollow-core PCF output were measured as a function of the input energy of the mid-IR driver W_0 (up to 50 μJ) and argon pressure p (varied from 1 to 16 bar), within a spectral range of several octaves, from the UV to the mid-IR, to confirm the prediction power of our numerical model and analyze the temporal evolution of mid-IR pulses.

To understand spectral and temporal transformations of an ultrashort mid-IR driver in a hollow PCF, we employ the field-evolution model based on the generalized nonlinear Schrödinger equation modified to include all the key physical phenomena that have been identified as significant factors behind the guided-wave evolution of ultrashort mid-IR pulses. Our simulations show that at sufficiently high W_0 and p , solitons are seen to undergo self-compression cycles, yielding field waveform transients with a pulse width shorter than the field half-cycle as a part of this oscillatory dynamics. In the frequency domain, these

sub-half-cycle soliton transients manifest themselves as multioctave supercontinua, detectable at the fiber output.

The research was supported by RFBR grants 19-02-00473 , 18-29-20031, 18-02-40025.

REFERENCES

- [1] F. Yu, J. C. Knight, *IEEE J. Sel. Topics Quantum Electron.* 22, 440610 (2016).
- [2] T. Balciunas, C. Fourcade-Dutin, G. Fan, T. Witting, A. A. Voronin, A. M. Zheltikov, F. Gerome, G. G. Paulus, A. Baltuska, and F. Benabid, *Nat. Comm.* 6, 6117 (2015).
- [3] F. Tani, F. Köttig, D. Novoa, R. Keding, and P. St. J. Russell, *Photon. Res.* 6, 84–88 (2018).
- [4] U. Elu, M. Baudisch, H. Pires, F. Tani, M. H. Frosz, F. Köttig, A. Ermolov, P. St. J. Russell, and J. Biegert, *Optica* 4, 1024–1029 (2017).

Formation of light bullet's spectrum cut-off in fused silica and fluorides

I. Yu. Geints¹, E. D. Zaloznaya^{1,2}, A. E. Dormidonov^{1,2}, S. V. Chekalin²,
V. O. Kompanets², V. P. Kandidov^{1,2}

¹ Faculty of Physics and International Laser Center, M.V. Lomonosov Moscow State University, Moscow, Russia;

² Institute for Spectroscopy Russian Academy of Sciences, Troitsk, Moscow, Russia;
e-mail: geintc.ii17@physics.msu.ru

Light bullets – extremely compressed high-intensity wave packets – form as a result of filamentation of femtosecond infrared radiation under the conditions of anomalous group velocity dispersion ($k_2 = \partial^2 k / \partial \omega^2 < 0$) in transparent dielectrics[1]. At the same time, in the anti-Stokes region of the spectrum of supercontinuum generated by the light bullet, a clearly isolated narrow wing is formed, separated from the central region with a broad spectral minimum.

The shift of the spectrum of the light bullet towards shorter wavelengths or, in other words, the position of its short-wavelength cutoff, as shown in [2], depends on the order of multiphoton plasma formation process. The order of multiphoton process, in turn, depends on the width of the band gap of the dielectric and on the central wavelength of the acting radiation, and determines the process of multiphoton ionization of the plasma produced by the light bullet. Still, the question of the existence of other factors affecting this spectrum shift remains unexplored.

In this paper, we investigated the impact of diffraction and dispersion of the wave packet on the formation of the short-wavelength cutoff in the supercontinuum spectrum of the light bullet. To do this, in numerical simulation, as in the planned laboratory experiment, we studied the spectrum of the femtosecond wave packets with different ratios of diffraction and dispersion lengths L_{diff}/L_{disp} ($L_{diff} = ka_0^2$, where a_0 is the initial beam radius; $L_{disp} = T_0^2/|k_2|$, where T_0 is the initial pulse duration). The media considered were: SiO₂, LiF, CaF₂; and the central wavelengths of wave packets referred to the region of anomalous group velocity dispersion.

It was found that the short-wavelength cutoff of the supercontinuum spectrum of the light bullet does not depend on the ratio L_{diff}/L_{disp} , while the formation interval of the anti-Stokes wing of the spectrum becomes longer with increasing beam size.

This work was supported by the Russian Science Foundation (Project No. 18-12-00422).

REFERENCES

- [1] Silberberg Y., Opt. Lett. (22). P. 1282-1284 (1990).
- [2] V.P. Kandidov, V.O. Kompanets, S.V. Chekalin, JETP Lett. (5), P. 307-331 (2018).

Cascade filamentation regime of high-power ultrashort laser pulse in air and bulk dielectric

Y. E. Geints¹, A. A. Ionin², D. V. Mokrousova², G. E. Rizaev², L V. Seleznev²,
E. S. Sunchugasheva² and A. A. Zemlyanov¹

¹ V.E. Zuev Institute of Atmospheric Optics, Siberian Branch, Russian Academy of Sciences (IAO SB RAS), Zuev square 1, 634021, Tomsk, Russia

² P.N. Lebedev Physics Institute, Russian Academy of Sciences (LPI RAS), Leninsky prosp. 53, 119991 Moscow, Russia

e-mail: ygeints@iao.ru

Experimental studies of specific cascade filamentation regime are reported when GW-power laser pulses experience successive filamentation initially in air and then in a bulk dielectric (silica glass). The spectral-angular characteristics of the supercontinual radiation emerging during this double filamentation are investigated. We show that the resulting pulse spectrum acquires wider broadening and enhanced angular divergence as compared to that of single laser filamentation solely in air or in a glass bar. As shown by our theoretical simulations, because of large-scale self-phase modulation during the primary filamentation in air the laser pulse becomes deeply chirped that influences the subsequent filamentation in a bulk dielectric.

Frequency up-conversion of IR femtosecond pulses from Yb:KYW laser in KGW crystal

I. A. Khodasevich, E. V. Lutsenko, M. V. Rzhetski and A. S. Grabtchikov

B.I.Stepanov Institute of Physics NAS of Belarus, Minsk, Belarus
e-mail: a.grabtchikov@dragon.bas-net.by

Generation of spectrally broadband femtosecond radiation in the visible range for the most part is associated with generation of supercontinuum [1]. In the meantime so called the supercontinuum-free approach using less involved nonlinear effects attracts interest as a way of nonlinear conversion infrared femtosecond pulses in the visible range [2]. Development of femtosecond laser systems with diode pumping operating in the near infrared stimulates investigations on up-conversion methods of their radiation into the visible spectrum.

We describe experimental results on frequency up-conversion of the infrared femtosecond pulses generated by the Yb:KYW oscillator-amplifier system with the central wavelength of output radiation near 1030 nm. The laser system delivered output pulses with the 62 kHz repetition rate, duration of 200 fs and energy up to 10 microJoules. The laser beam was tightly focused into the KGW crystal.

Spectral characteristics of visible beams generated in the forward direction and luminescence of the visible channel, created in the crystal by focused pump beam were investigated. Power thresholds of channel luminescence and forward visible beams were measured also.

Grows of the pump power in our experiment was accompanied by the appearance of the visible radiation in a waist of pump beam and development of the forward visible beams accompanied by angled structure. The appearance of visible luminescence and beams had the threshold character. Measurements demonstrated some spectral bands in the visible range. The most intensive up-converted radiation was concentrated in the green-red spectral range (550-750 nm at the background). The second spectral band was observed in the ultraviolet range at the central wavelength of 342 nm and the spectral bandwidth about 330-350 nm at background.

The UV spectral part and the green-red band of frequency converted radiation can be interpreted in terms of the third harmonic and Cherenkov generation discussed in relation to photonic crystal fibers [see for example 3, 4].

REFERENCES

- [1] R. R. Alfano, ed., The Supercontinuum Laser Source (Springer-Verlag, 1989).
- [2] H. Tu and S. A. Boppart, OPTICS EXPRESS 17, 9858 (2009).
- [3] S.O.Konorov et.al. JETP Letters, 80m, 190, (2004).
- [4] C. Milián, A. Ferrando, and D. V. Skryabin JOSA B, 29, 589 2012.

New approaches for THz wave generation and detection in nonlinear crystals and photoconductive materials

G. Kh. Kitaeva, K. A. Kuznetsov and A. A. Leontyev

Lomonosov Moscow State University, Faculty of Physics, 119991 Moscow, Russia;
e-mail: gkitaeva@physics.msu.ru

There are two alternative approaches in construction of laser-driven terahertz (THz) wave generators and detectors, one based on frequency conversion in nonlinear crystals, and the other one utilizing laser-excited currents in photoconductive materials. Recent progress in the both directions is stimulated by important applications of THz electromagnetic waves in communications, spectroscopy, biomedicine, tomography and other fields.

Concerning nonlinear processes, our last work is devoted to generation of THz fields with particular quantum properties. We show that effect of spontaneous parametric down-conversion (SPDC), well known in the modern quantum optics and quantum information, can be used as a source of quantum-correlated pairs of photons of extremely different frequency ranges, the so-called “optical-terahertz biphotons” [1]. This opens attractive perspectives to move the quantum information and quantum photometry technologies to the terahertz range. High levels of correlation are achieved when the strongly frequency non-degenerate SPDC proceeds in the low-gain limit. The possibility of detecting the weakest terahertz photon fluxes has been demonstrated recently [2] by using a superconductive hot-electron bolometer.

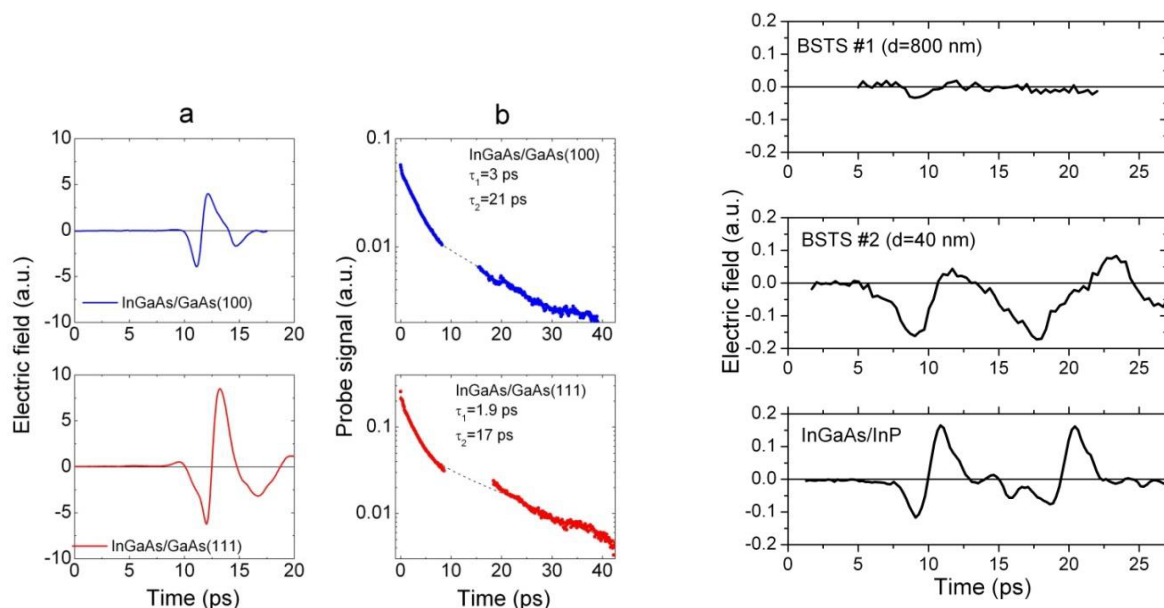

Figure 1: (left), Figure 2: (right)

The photoconductive antennas based on low-temperature grown InGaAs semiconductors are perspective devices for classical schemes of THz-wave detection

and generation. The relatively large band-gap (1.4 eV) of GaAs restricts the set of appropriate laser sources capable of exciting carriers in antennas based on this material. This circumstance stimulated the search of semiconducting materials having the advantages of GaAs, but with smaller band-gaps, allowing absorption of radiation from lasers that are used in optical communications. We studied the THz wave generation by the time-domain spectroscopy method in the spiral antennas fabricated on the low-temperature grown InGaAs layers on GaAs substrates with crystallographic orientations (100) and (111) [3]. It was found that the THz wave generation is 3-4 times more effective in the case of (111)A GaAs substrates as compared to the (100) substrates (Fig.1a). By analyzing results of the pump-probe measurements, the characteristic carrier relaxation times were obtained for LT-InGaAs samples on GaAs substrates with (111) A and (100) orientations (Fig.1b). These results are in a good correspondence with the literature data and qualitatively confirm the results of experiments on the THz generation.

Topological insulators are also very promising materials, both for THz wave generation and detection. Due to inversion of energy bands, that takes place on a surface of a topological insulator (TI), the new “topologically protected” electronic states with a linear spectrum appear. We have studied the emission of THz radiation by samples of topological insulators $Bi_{2-x}Sb_xTe_{3-e}Se_y$ (BSTS) with various thicknesses and chemical compositions, pumped by 2.5 ps laser pulses of 1.56 μm wavelength. Rhombohedral BSTS films were grown on (0001) sapphire substrates. It was found that the electric field of the THz signal from the island film of TI is 5 times higher than the same of TI samples with a thickness of hundreds of nanometers (Fig.2). The effect of THz radiation amplification in an external electric field in a topological insulator has been demonstrated for the first time [4].

This work was supported by RFBR grants 18-29-20101 and 19-02-00598.

REFERENCES

- [1] Kitaeva G.Kh, Kornienko V.V., Leontyev A.A. et al. Phys. Rev. A, 98, 063844-1 (2018).
- [2] Kitaeva G.Kh, Kornienko V.V., Kuznetsov K.A., et al. Optics Letters, 44, 1198 (2019).
- [3] Kuznetsov K.A., Galiev G.B., Kitaeva et al. Laser Physics Letters, 15, 076201 (2018).
- [4] Kuznetsov K.A., Kitaeva G.Kh, Kuznetsov P.I et al. AIP advances, 9, 015310-1 (2019).

Dispersion influence on femtosecond pulse self-shortening efficiency in fused silica

A. V. Koribut¹, Ya. V. Grudtsyn¹, L. D. Mikheev^{1,2}, V. A. Trofimov³ and V. I. Yalovoi¹

¹P.N. Lebedev Physical Institute of Russian Academy of Sciences, Moscow, Russia

²National Research Nuclear University "MEPhI", Moscow, Russia

³Moscow State University, Moscow, Russia;

e-mail: andrew-koribut@yandex.ru

Ultrashort high energy pulses are a key tool in the area of strong-field laser-matter interaction. Pulses with duration of a few optical cycles are required in investigation of dynamics of ultrafast processes in a substance, the generation of high-order harmonics and isolated attosecond pulses. Chirped pulse amplification method made it possible to achieve petawatt power level in solid state systems. However the duration of such pulses exceeds 20-30 fs due to the spectrum narrowing during amplification. To solve this problem, various extra cavity compression methods are developed, which are based on nonlinear spectral broadening due to self-phase modulation (SPM) and subsequent compensation of acquired non-linear phase using dispersive elements (post compression) or without using them in the case when a pulse close to transform-limited one is formed during nonlinear interaction process (self-compression or self-shortening). Earlier [1], we proposed the self-shortening method for femtosecond pulses in thin fused silica sample, which is realized at high values of the B-integral. In this regime, multiple self-focusing develops in the central part of the pulse leaving plasma traces in the pulse tail. As a result, due to increase of the angular losses in the central and back parts of the pulse, radiation from the unperturbed leading edge remains on the axis leading to the pulse self-shortening in the far-field.

In this work, we present experimental and numerical study of dispersion influence on the self-shortening. In experiments, we used fused silica samples with a thickness of 1 mm and 3 mm, which are much shorter than the dispersive length for the initial transform-limited pulse with parameters: FWHM duration 72 fs, central wavelength 472 nm, pulse energy up to 200 μJ . The diaphragm placed immediately after the sample selected the central part of the beam with a nearly constant intensity. Self-shortening of femtosecond pulses occurred at an intensity of 2.9 TW/cm² in the 1 mm sample and 1.1 TW/cm² in the 3 mm sample. The duration of self-shortened pulses was 23 fs and 32 fs, respectively. For each of the samples, the formed pulses are close to transform-limited ones, which is confirmed by the close coincidence of the experimentally measured autocorrelation function and autocorrelation function obtained using the inverse Fourier transform from the pulse spectrum. To explain the experimentally observed dependence of shortened pulse duration against the sample thickness, numerical

simulations were performed, which showed that the leading edge of the pulse is stretched depending on the sample thickness. Also, the obtained spectral shift agrees well with the experiment.

The results show that the use of samples with a thickness much less than the dispersion length does not guarantee the optimal condition of the self-shortening regime, since the effect of the SPM enhances the effect of dispersion. The choice of parameters of the samples necessary for the effective implementation of the self-shortening regime is discussed.

REFERENCES

- [1] Ya. V. Grudtsyn, A. V. Koribut, V.A. Trofimov, L. D. Mikheev, *Journal of the Optical Society of America B*, 35 (5), 1054 (2018)

Fundamental role of gradient optics phenomena at laser beam interaction with contrast structures induced by optical pulse

V. A. Trofimov¹, M. M. Loginova¹ and V. A. Egorenkov¹

¹ Lomonosov Moscow State University, Moscow, Russia;
e-mail: vatro@cs.msu.ru

We analyze femtosecond laser pulse interaction with a semiconductor under the condition of absorption optical bistability existence. In this case the domains of a high concentration of charged particles and the high laser energy absorption kink structures are formed. Under certain conditions the most part of the laser energy can be reflected from the high absorption domain boundary. This phenomenon takes place due to the presence of the high gradient of a medium optical property [1]. For adequate description of the process it is necessary to consider the beam longitudinal diffraction. To describe a process of a partial light reflection from the domains boundaries we have proposed a new mathematical model. It consists from the system of differential equations concerning free electron and ionized donors concentration, Poisson equation concerning induced electric field potential. Its main feature consists in are placement of the equation concerning the laser pulse intensity [2] by the Schrödinger equation with respect to the complex amplitude of a wave packet, slowly varying in time only (Fig.1).

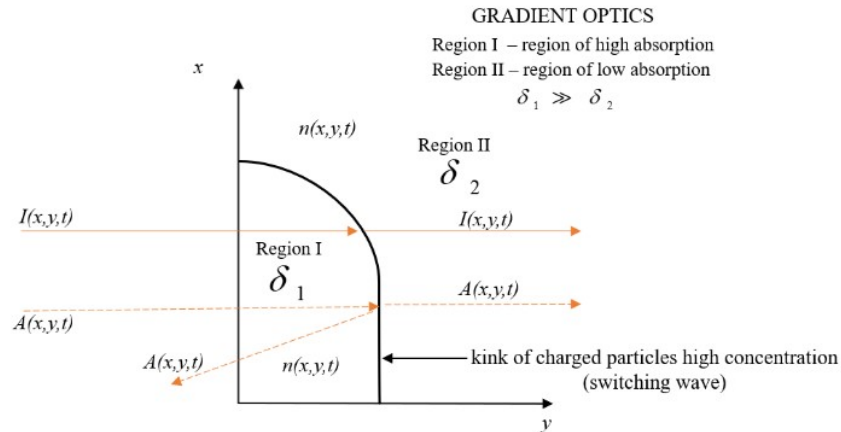

Figure 1: Scheme of boundary between the domains with high and low concentration of free electrons in 2D case and influence of gradient media properties on the mathematical model of the problem.

For solving this system numerically, we had developed conservative finite-difference scheme and special iteration process for its realization [3]. On the base of computer modeling we demonstrated the laser pulse reflection from the boundary of high absorption domain. The high absorption domain appears with certain delay with respect to the pulse front propagation. We see strong

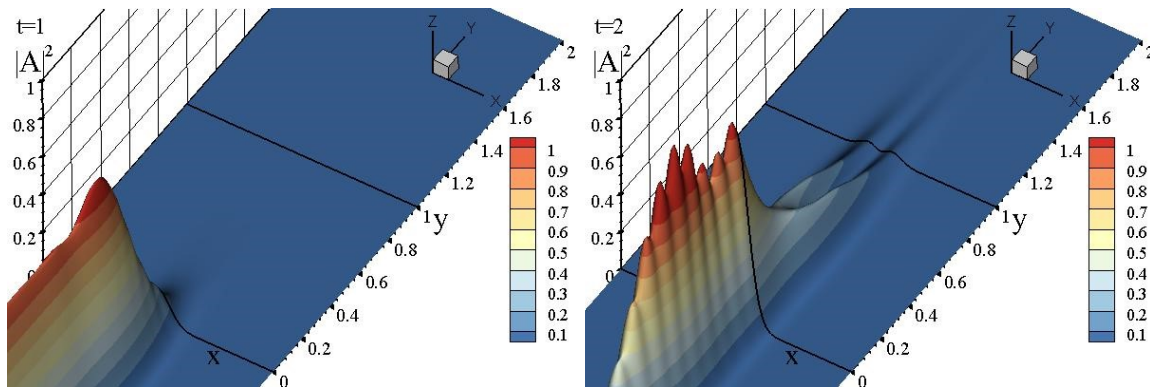

Figure 2: Evolution of the pulse intensity profile at the interaction with fixed high absorption domain.

reflection from this domain boundary placed inside a semiconductor. It results in incident pulse intensity oscillation at the beam axis (Fig. 2).

This work was supported by the Russian Science Foundation (Grant N 19-11-00113).

REFERENCES

- [1] A.B. Shvartsburg, A.A. Maradudin, *Waves in Gradient Metamaterials*, World Scientific (2013).
- [2] R. Smith, *Semiconductors*, Cambridge University Press (1978).
- [3] V.A. Trofimov, M.M. Loginova, and V.A. Egorenkov, *Int. J. Math. Comput. Sci.* DOI: 10.1080/00207160.2018.1492117 (2018).

Nonlinear chirped soliton formation at laser pulse propagation in a nonlinear medium with (or without) nonlinear absorption

V. A. Trofimov¹ and T. M. Lysak¹

¹ Lomonosov Moscow State University, Moscow, Russia;
e-mail: vatro@cs.msu.ru

We investigate analytically and numerically a novel type of solitons – nonlinear chirped solitons, which can be formed in various nonlinear media. This type of solitons is characterized by a nonlinear complicated chirp (frequency change in time) or wave front aberration (wave number nonlinear change in space) of laser radiation. We have shown the possibility of the nonlinear chirped solitons formation in such media as the media with multi-photon absorption, the media with noble metal nanoparticles (in particular, nanorods) and nonlinear photonic crystals. We described the main features of this soliton propagation in considered media. Our investigation is based on the nonlinear Schrodinger equation, which can be supplemented by one or more ordinary differential equations to describe the medium response. A new analytical approach proposed by us allowed developing the approximate analytical soliton solutions of the problems under investigation. We confirmed our analytical results by computer simulation based on conservative finite-difference schemes.

The investigation was made using support of the Russian Science Foundation (Grant N 19-11-00113).

Femtosecond pulse self-shortening in Kerr media due to small-scale self-focusing

L. D. Mikheev^{1,2}, Ya. V. Grudtsyn¹, A. V. Koribut¹, V. A. Trofimov³

¹ P.N. Lebedev Physical Institute, Russian Academy of Sciences, Moscow, Russia;

² National Research Nuclear University “MEPhI” (Moscow Engineering Physics Institute), Moscow, Russia;

³ Faculty of Computational Mathematics and Cybernetics, M.V. Lomonosov Moscow State University, Moscow, Russia

e-mail: mikheev@sci.lebedev.ru

A novel femtosecond pulse self-shortening technique based on the regime of multiple small-scale self-focusing in thin samples with Kerr nonlinearity [1-5] will be discussed in the presentation. In this regime, a pulse passing through the sample keeps its front part unaffected by the multiple self-focusing while the beam in the central and trailing parts of the pulse becomes broken down due to self-focusing and plasma formation. As a result, strong on-axis intensity losses arise in these parts that allows far-field spatial filtering of the pulse front edge without the use of additional dispersive elements. Spectrum broadening due to self-phase modulation at the pulse front edge ensures the output bandwidth supporting truncated pulse duration. Results obtained in these studies show that this technique is simple and has, in principle, no limit in energy up-scaling. The role of modulational instability and material dispersion in the mechanism of femtosecond pulse self-shortening will also be discussed in the talk.

REFERENCES

- [1] Aristov A.I., Grudtsyn Ya.V., Mikheev L.D., Polivin A.V., Stepanov S.G., Trofimov A.V., Yalovoi V.I. *Quantum Electron.*, 42, 1097 (2012) [*Kvantovaya Elektron.*, 42, 1097 (2012)].
- [2] Grudtsyn Ya.V., Zubarev I.G., Koribut A.V., Kuchik I.E., Mamaev S.B., Mikheev L.D., Semenov S.L., Stepanov S.G., Trofimov V.A., Yalovoi V.I. *Quantum Electron.*, 45, 415 (2015) [*Kvantovaya Elektron.*, 45, 415 (2015)].
- [3] Grudtsyn Ya.V., Koribut A.V., Trofimov V.A., Mikheev L.D. *J. Opt. Soc. Am. B*, 35, 1054 (2018).
- [4] Grudtsyn Ya.V., Koribut A.V., Mikheev L.D., Trofimov V.A. *Quantum Electron.*, 48, 306 (2018) [*Kvantovaya Elektron.*, 48, 306 (2018)].
- [5] Grudtsyn Ya.V., Koribut A.V., Mikheev L.D., Trofimov V.A., Yalovoi V.I. *Quantum Electron.*, 49, 302 (2019) [*Kvantovaya Elektron.*, 49, 302 (2019)].

Energy deposition and terahertz radiation generation under the loose focusing of two-color radiation in air

E. V. Mitina¹, A. A. Ushakov^{1,3}, D. V. Pushkarev¹, D. S. Uryupina¹,
O. G. Kosareva^{1,2}, A. B. Savel'ev^{1,2}

¹Faculty of Physics, Lomonosov Moscow State University, Moscow, Russia;

²International Laser Center, Moscow, Russia;

³Prokhorov General Physics Institute of the Russian Academy of Sciences, Moscow, Russia
e-mail: convallaria_lo@mail.ru

Femtosecond laser filaments in air are the source of terahertz radiation and can provide a remote diagnostics of objects. Mixing the main and second harmonics (two-color filamentation) increases the conversion efficiency into terahertz radiation by about 3 orders of magnitude.

In our experiments we used laser system, based on Ti:Sa crystal (805 nm, 1-10 Hz, beam diameter (FWHM) 8 mm, energy up to 20 mJ, pulse duration 55 fs) to form filaments. The filament was created in air by different lenses (focal lengths from 30 cm to 312 cm). The two-color radiation was generated in a nonlinear BBO crystal mounted in a converging laser beam. The second harmonic of radiation was generated with a maximum efficiency of about 10%.

For the energy deposition diagnostics we used two independent methods. Firstly, the terahertz radiation was detected using a Golay detector (Tydex, GC-1P) with two teflon lenses (diameter – 5 cm, focal lengths – 10 and 6 cm). Since the Golay detector is intended firstly to record the power of quasi-continuous terahertz radiation, we had conducted a test experiment to calibrate the Golay detector in the recording mode of a single terahertz pulse. Secondly, to reveal multifilament transverse spatial structure and the relative plasma concentration we employed the novel high-resolution acoustic method [1]. We made acoustic measurements in the extensive number of longitudinal coordinate points thus acquiring filament evolution information.

The maximum energy of the terahertz pulse was observed at $F = 50$ cm, at $F = 30$ cm the recorded terahertz signal was less. However, the terahertz radiation could not be detected at long focal lengths (75, 100, and 312 cm). Focusing with a $F = 30$ cm lens, the dependence of the terahertz pulse energy on the input laser pulse energy is close to linear. Focusing with a $F = 50$ cm lens, the terahertz signal increases significantly – about 3.7 times at a laser pulse energy of 10 mJ. With further energy increase in this mode, the terahertz signal decreases. It was possibly due to space-time mismatch of the radiation of the first and second harmonics.

This work was supported by RFBF under grant #18-02-00954

REFERENCES

[1] D.S.Uryupina et al., Laser Physics Letters, 13 (9), 095401 2016

Quantitative analysis of laser plasma images obtained by the nonlinear phase contrast method, estimation of plasma density

A. A. Murzanev

Federal Research Center Institute of Applied Physics of the Russian Academy of Sciences (IAP RAS), Nizhny Novgorod, Russia;
e-mail: alex_murz@mail.ru

The analysis of small scale phase objects making a minor phase shift is a rather difficult task demanded in different fields of science. Traditional methods of interferometric studying require additional processing of experimental data [1] to get the phase value. The group of shadow imaging methods is very helpful at phase object imaging [2] but quantitative analysis of the images is not commonly used. Using of the phase contrast imaging method [3] useful for visualization of the objects in biology also can provide qualitative values for an object under study. But this method of visualization is difficult in experimental realization. The advanced nonlinear phase contrast method has an advantage due to the rather simple way of the optical scheme alignment. Its realization gives an opportunity of visualization of the transparent phase object but also saves an opportunity of the quantitative analysis.

The modeling of phase object image in the nonlinear optical scheme was made using the Fourier optics method. The visualization of phase objects was investigated numerically. The relationship between the magnitude of the phase shift and changes in the image was received. The results obtained are compared with the experimental results for the visualization of a laser plasma filament in the air. The femtosecond laser radiation has enough intensity in probe beam to provide the required level of the laser light intensity to make the nonlinear imaging possible. At the same time pump beam was used to create laser plasma channel. The results of modeling are in good agreement to the experimental results.

The research is supported by the RFBR (grant N 18-32-00949)

REFERENCES

- [1] M. Takeda, Mitsuo; H. Ina, S. Kobayashi, JOSA 72 (1), pp. 156-160 (1982).
- [2] L.A. Vasiliev, "Tenevye metody", M. 1968. [in Russian]
- [3] J. Glückstad, D. Palima, Generalized phase contrast, Springer, 0342-4111, 146, (2009).

Lasing from Nitrogen plasma filaments

A. Mysyrowicz

LOA, ENSTA, École polytechnique, Palaiseau, France
e-mail: andre.mysyrowicz@ensta-paristech.fr

The plasma column generated during filamentation of near IR femtosecond laser pulse in air displays remarkable cavity-free lasing properties. Depending on the polarization of the pump pulse (circular or linear), lasing occurs either from neutral or singly ionized nitrogen molecules. In this talk I will mainly discuss the lasing in N_2^+ and show that it displays remarkable quantum interference effects.

Intense THz radiation obtained by TW laser pulses filamentation in a low-pressure nitrogen

M. M. Nazarov¹, A. V. Mitrofanov^{1,2,3}, D. A. Sidorov-Biryukov^{1,3,4},
M. V. Chaschin¹, A. A. Voronin^{3,4}, A. M. Zheltikov^{1,3,4,5} and
V. Ya. Panchenko^{1,2,4}

¹ National Research Center “Kurchatov Institute“, Moscow, Russia;

² FSRC “Crystallography and Photonics“ of the RAS, Moscow Russia;

³ Russian Quantum Center, Novaya 100, Skolkovo, Moscow Region, Russia;

⁴ ILC and Physics Department M.V. Lomonosov Moscow State University, Moscow, Russia

⁵ Department of Physics and Astronomy, Texas A&M University, College Station, Texas, USA;

e-mail: nazarovmax@mail.ru

Single-cycle terahertz (THz) pulses with high intensity electric field can be obtained by the conversion of multi-terawatt femtosecond laser radiation. Conversion into THz range via two-color laser-induced filament is one of perspective methods, it is free from damage threshold and phonon absorption inherent to more efficient method of laser frequency conversion in nonlinear crystals. The possibility to scale THz generation in a filament to high energies has long been discussed [1-3]. For optimal filament performance, its parameters should be scaled according to certain rules [4], along with the energy we should increase the beam size, the focus length, as well as to reduce the pressure. We use laser system “Pulsar 200 TW“ installed in NRC “Kurchatov Institute“, capable of generating 800 nm, 25 fs pulses with energy of up to 7 J. In present work cell glass windows limits useful energy below 60 mJ. With 2.5 m focusing mirror and 70 mm diameter beam we double laser radiation in 150 μ m, large aperture KDP crystal and launch a 20 cm long two-color filament in nitrogen. The pressure decreasing from ambient to tens of mbar, avoids multiple filamentation and excessive ionization and provides a two orders gain in the THz generation efficiency, see insert on Figure 1.

We observe saturation of THz yield at energies above 40 mJ in all modifications of the experiment. Even for very low (1 mbar) pressure, for chirped pulse, for low intensity at SHG crystal. This THz yield saturation, besides plasma scattering is affected by self-phase modulation (SPM) of TW pulse in glass windows. Besides SHG spectra is broadened and shifted with pressure increase, see Fig.1.

We estimate detectable THz bandwidth (< 3 THz) by electro-optical sampling. Improving SPM and absorption in filters we expect to exceed 10^{-4} efficiency level for THz generation at TW pumping. We estimate THz pulse energy and maximal field to be 1 μ J and 0.3 MV/cm. The known THz generation scenario, which was studied in detail for short focus and atmospheric pressure, is not confirmed for this range of parameters. Novel approach should be suggested.

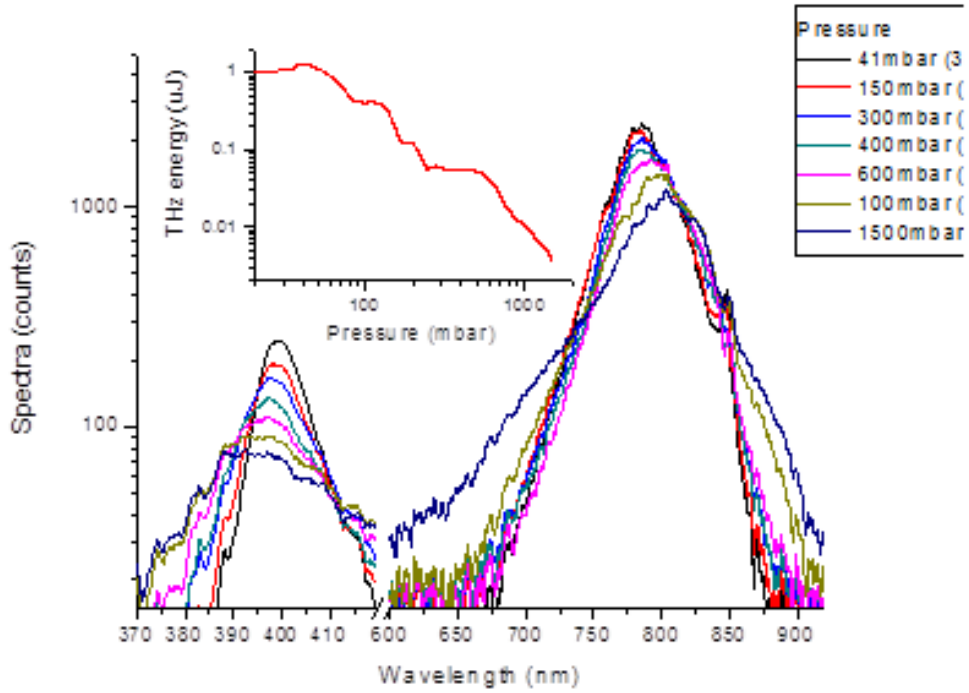

Figure 1: Spectra of laser fundamental and second harmonic after two-color filament for various nitrogen pressure with 40 mJ laser pulses and 40 cm distance from doubling crystal to filament center. Insert - THz yield vs nitrogen pressure for this case.

This work was partially supported by RFBR grants 18-52-16024, and 18-02-40032

REFERENCES

- [1] T. J. Wang, Y. Chen, C. Marceau, etc. *Appl.Phys.Lett.* 95, 131108, (2009).
- [2] Y. J. Yoo, D. Kuk, Z. Zhong, K. Y. Kim *IEEE J. of Sel.Top.Quant.Electronics* 23, 1-7, (2017)
- [3] Oh, T.I., You, Y.S., Jhajj, N., etc *New Journal of Physics*, 15(7), 075002. (2013).
- [4] Zhokhov, P. A., & Zheltikov, A. M. *Phys. Rev. A*, 89(4), 043816, (2014).

Terahertz generation from two-color laser induced breakdown in pressurized gases

I. A. Nikolaeva¹, P. M. Solyankin², A. A. Angeluts¹, D. E. Shipilo^{1,3},
N. V. Minaev⁴, N. A. Panov^{1,3}, A. V. Balakin¹, Y. Zhu⁵, A. P. Shkurinov^{1,2,6}
and O. G. Kosareva^{1,3}

¹Physics Faculty and International Laser Center, M. V. Lomonosov Moscow State University, Moscow, Russia

²IPLIT RAS, Federal Scientific Research Centre “Crystallography and Photonics” of Russian Academy of Sciences, Moscow, Russia

³P. N. Lebedev Physical Institute of Russian Academy of Sciences, Moscow, Russia

⁴Federal Scientific Research Centre “Crystallography and Photonics” of Russian Academy of Sciences, Moscow, Russia

⁵Terahertz Technology Innovation Research Institute, Shanghai Key Laboratory of Modern Optical System, Terahertz Spectrum and Imaging Technology Cooperative Innovation Center, University of Shanghai for Science and Technology, Shanghai, China

⁶The National University of Science and Technology MISiS, Moscow, Russia
e-mail: kosareva@physics.msu.ru

We studied the terahertz (THz) emission from optical breakdown in carbon dioxide and air under the pressure varied from 0.01 to 10 bar. In the experiment, the optical breakdown was induced by two-color 800 nm + 400 nm field focused into the cuvette with the pressurized gas. The optimal pressure which maximizes the detected THz signal is found to be 1.5 bar for air and 0.5 bar for CO₂. In the simulations based on Unidirectional pulse propagation equation, we reproduce the experimentally obtained dependencies. The optimal pressure for THz generation is associated with the maximal plasma density obtained under certain focusing in the gas: for higher pressures, the clamped intensity becomes lower and the ionization rate decrease cannot be compensated by the neutral density growth, while for lower pressures the depletion of neutrals occurs and limits the free electron density.

This work was partially supported by the Russian Foundation for Basic Research under Grants 18-52-16016, 18-29-20104, 17-02-01217, 18-52-16020, 18-32-01000, 18-02-00954.

Modelling of the amplification of UV radiation in Nitrogen plasma filaments.

E. Oliva^{1,2}

¹ Departamento de Ingeniería Energética, E.T.S.I. Industriales, Universidad Politécnica de Madrid, Madrid, Spain;

² Instituto de Fusión Nuclear, Universidad Politécnica de Madrid, Madrid, Spain;
e-mail: eduardo.oliva@upm.es

In this paper we present the computational tools available at the Instituto de Fusión Nuclear (Universidad Politécnica de Madrid) that are used to study the lasing effect in Nitrogen plasma filaments and, more generally, plasma-based amplifiers of UV, XUV and soft X-ray radiation. The forward and backward amplification of radiation is studied with 1D (DeepOne [1]) and 3D (Dagon [2]) Maxwell-Bloch codes, enhanced with a plasma model for the filament. Recent results on amplification in Nitrogen filaments will be presented [3,4].

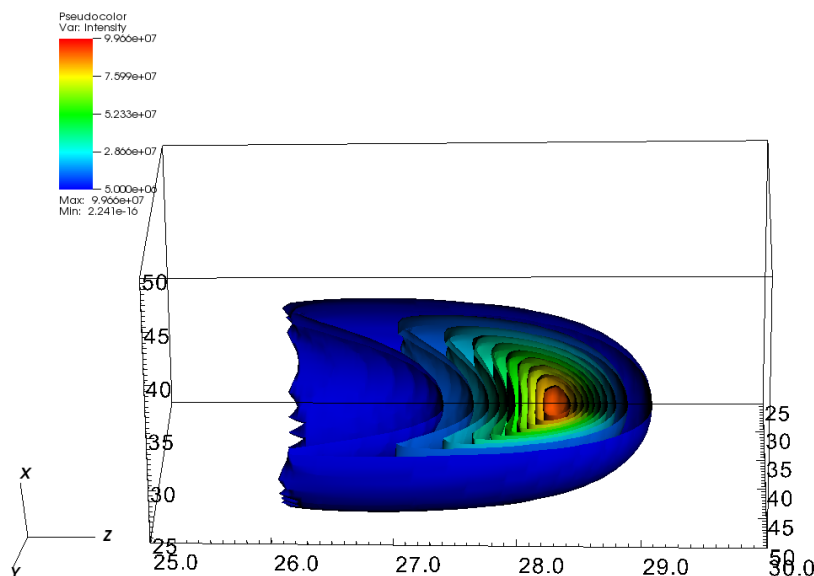

Figure 1: Intensity isocontours of a UV seed pulse amplified in a Nitrogen plasma filament, as modelled with our 3D time-dependent Maxwell-Bloch code Dagon

REFERENCES

- [1] E. Oliva, et al, Phys. Rev. A 84, 013811 (2011)
- [2] E. Oliva, et al, Proc. of SPIE Vol. 10243, 1024303 (2017)
- [3] P. Ding, et al, Phys. Rev. A 94, 043824 (2016)
- [4] P. Ding, et al, Phys. Rev. A 96, 033810 (2017).

Nonparaxial input for propagation equations: tight-focusing case

V. V. Pankratov^{1,2}, I. A. Nikolaeva¹, D. E. Shipilo^{1,2}, V. Yu. Fedorov^{2,3},
N. A. Panov^{1,2}, S. Tzortzakis³, A. Couairon⁴ and O. G. Kosareva^{1,2}

¹Physics Faculty and International Laser Center, M. V. Lomonosov Moscow State University, Moscow, Russia

²P. N. Lebedev Physical Institute of Russian Academy of Sciences, Moscow, Russia

³Science Program, Texas A&M University at Qatar, Doha, Qatar

⁴CPHT, CNRS, Ecole Polytechnique, Institut Polytechnique de Paris, Palaiseau, France
e-mail: kosareva@physics.msu.ru

Using the geometric optics considerations, we derive input conditions for simulations of tightly focused electromagnetic fields by means of unidirectional nonparaxial vectorial propagation equations [1,2]. Considering ray propagation and energy flux conservation along the ray, we show the explicit form of transformation that should be applied to the beam transverse distribution so its focusing by concave mirrors can be simulated using UPPE [1] or UHPE [2]. For example, for a parabolic mirror with focal length f , the initial electric field distribution for a harmonic of frequency ω with the wave number k can be written as

$$E_e(X, Y, z = 0) = E_0(x, y) \frac{4f^2 - r^2}{4f^2 + r^2} \left\{ \left(\frac{x^2 - y^2}{4f^2} - 1 \right) \mathbf{e}_x + \frac{xy}{2f^2} \mathbf{e}_y - \frac{x}{f} \mathbf{e}_z \right\} \times \\ \times \exp \left(i \frac{2k r^2 f}{4f^2 - r^2} \right),$$

where the service coordinates are

$$r(R) = \frac{2f}{R} \left(\sqrt{f^2 + R^2} - f \right); \quad X = Rx/r; \quad Y = Ry/r,$$

and $E_0(x, y)$ is a transverse distribution of incident field complex amplitude. We have benchmarked numerical solutions of propagation equations initiated with the nonparaxial input conditions against the solutions of Maxwell equations obtained by vectorial diffraction integrals.

This work was supported by the Russian Foundation for Basic Research (Grants 18-52-16020, 18-32-01000, 18-02-00954).

REFERENCES

- [1] M. Kolesik, J. V. Moloney, Phys. Rev. E 70, 036604 (2004).
- [2] A. Couairon et al., Opt. Express 23, 31240 (2015).

New horizons of extreme nonlinear optics driven by mid-IR femtosecond multi-gigawatt-class Fe:ZnSe laser operating at 4.4 μm

E. Migal¹, A. Pushkin¹, B. Bravy², V. Gordienko¹, N. Minaev³ and
F. Potemkin¹

¹ Faculty of Physics and International Laser Center M.V. Lomonosov Moscow State University, Russia, Moscow, Leninskie Gory, bld.1/62, 119991

² Institute of Problems of Chemical Physics, Chernogolovka, Moscow, Russia, 142432

³ Institute of Photon Technologies of Federal Scientific Research Centre “Crystallography and Photonics“ of Russian Academy of Sciences, Russia, Moscow, Troitsk, Pionerskaya 2, 108840
e-mail: potemkin@physics.msu.ru

We have designed and performed mid-IR (4-5 μm) gigawatt (>20 GW) power all solid state femtosecond Fe:ZnSe laser system composed of robust mid-IR (4-5 μm) seed pulse source based on a high energy (up to 40 μJ) three stage AgGaS₂ OPA; stretcher/compressor stage and multi-pass Fe²⁺:ZnSe amplifier with total gain of 1125, pumped by a solid-state Q-switched Cr:Yb:Ho:YSGG laser (50 mJ, 2.85 μm , 10 Hz) with output energy up to 3.5 mJ after the compression stage. Here we report experimental results on mid-IR filamentation in xenon using 4.4- μm 150-fs pulses delivered by Fe:ZnSe laser system. Broadband supercontinuum (SC) spans across four-octaves from 350 nm up to 5.5 μm . This broadband source offers a unique tool for high resolution spectroscopy from visible to mid-IR. We believe that careful adjustment of the pressure or/and cell length may also lead to filamentation assistant self-compression to few-cycle pulses.

Photoacoustic diagnostics of the deposited energy density under femtosecond filamentation in condensed matter.

B. V. Rumiantsev^{1,3}, E. I. Mareev^{1,3}, A. S. Bychkov^{1,2}, A. A. Karabutov^{2,3},
V. A. Makarov^{1,3}, E. B. Cherepetskaya² and F. V. Potemkin^{1,3}

¹ Faculty of Physics, M.V.Lomonosov Moscow State University, Moscow, Russian Federation;

² Moscow Mining Institute, the National University of Science and Technology MISiS, Moscow, Russian Federation;

³ International Laser Center, M.V.Lomonosov Moscow State University, Moscow, Russian Federation;

e-mail: rumjancev.bv15@physics.msu.ru

Using the photoacoustic technique we investigate the value of the deposited energy density in the regime of femtosecond filamentation in condensed matter under different focusing conditions and different peak-to-critical power ratios ($P_{peak} = P_{cr}$ up to 250 taking into account the linear absorption of the medium). Also in the framework of this research the dependence of deposited energy density on the realized regime of laser-matter interaction was studied.

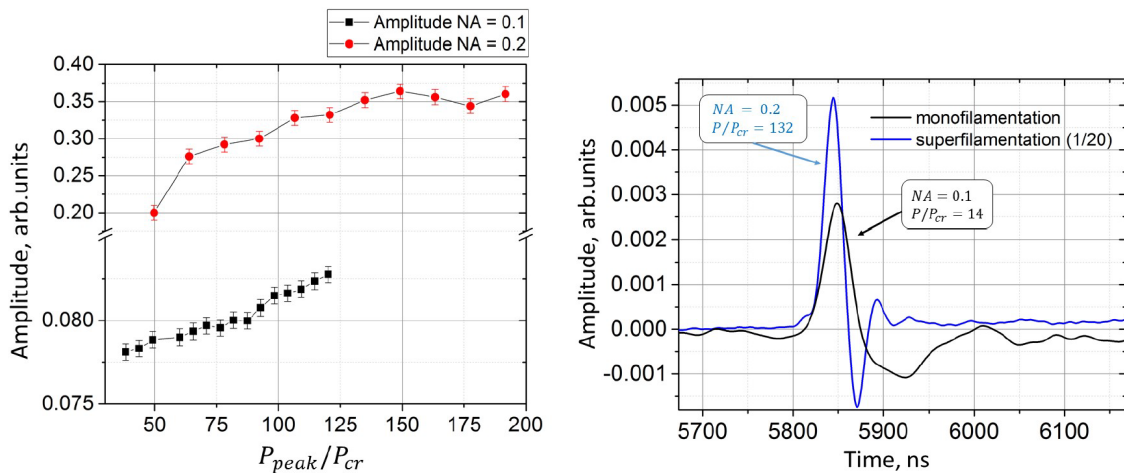

Figure 1: Left image demonstrates dependence of the acoustic signal amplitude on the $P_{peak} = P_{cr}$; right image demonstrates comparison of the acoustic signals generated by mono- and superfilament.

The water was chosen as a condensed medium for the investigation due to the relatively low acoustic attenuation and well-studied optical and acoustic parameters. Under excitation of water ($P_{cr} = 6.4MW$ for the pulses with $\lambda_{central} = 1240nm$) by femtosecond (170 fs) near-IR laser pulses with energy up to 450 uJ ($P_{peak} = 2650MW$) the femtosecond filamentation process occurs [1]. The femtosecond filament generates acoustic pulse propagating in the water, that was registered by wideband piezoelectric detector (about 100 MHz) [2]. The acoustic wave is generated due to the thermo-optical mechanism [3] and therefore its amplitude is proportional to the energy deposition into the medium. This

fact allows to conduct diagnostics of the deposited energy by registration of the acoustic wave induced by the filament [4].

Based on the photoacoustic method we revealed, that efficiency of the energy deposition process grows with an increase of the numerical aperture (NA) of the focusing system. It was shown, that in case of tighter focusing conditions (NA = 0.2) the dependence of the acoustic signal amplitude (and, therefore, the dependence of the energy deposition) on the ratio P_{peak}/P_{cr} reaches saturation at smaller ratios in comparison with the case of looser focusing (NA = 0.1) (fig. 1, left).

It was also shown, that acoustic signal amplitude grows nonlinearly under transition from the monofilamentation regime to the superfilamentation regime (more than 20 times in our experiment), that indicates the nonlinear growth of the energy deposition (fig. 1, right).

This work was supported by the Russian Fund for Basic Research (RFBR 18-32-00696); E.I Mareev and B.V. Rumiantsev are the scholars of the Foundation for the Advancement of Theoretical Physics BASIS.

REFERENCES

- [1] A. Couairon and A. Mysyrowicz, Femtosecond filamentation in transparent media, *Phys. Rep.*, vol. 441, no. 24, pp. 47189, 2007.
- [2] F.V. Potemkin, E.I. Mareev, B.V. Rumiantsev, A.S. Bychkov, A.A. Karabutov, E.B. Cherepetskaya and V.A. Makarov, “Two-dimensional photoacoustic imaging of femtosecond filament in water“, *Laser Phys. Lett.*, vol. 15, 075403, 2018.
- [3] V.E. Gusev, A.A. Karabutov, “Laser optoacoustics“, New York: American Institute of Physics, 1993.
- [4] Boris Rumiantsev, Evgenii Mareev, Anton Bychkov, Vladimir Makarov, Aleksandr Karabutov, Elena Cherepetskaya and Fedor Potemkin, “Photoacoustic and optical imaging of the femtosecond filament in water,“ *Proc. SPIE 11026, Nonlinear Optics and Applications XI*, 1102606, 2019.

The source of high-intensity THz pulses to study the effect on living cells

D. S. Sitnikov¹, I. V. Ilyina¹, V. A. Revkova², M. A. Konoplyannikov²,
V. A. Kalsin² and V. P. Baklaushev²

¹ Joint Institute for High Temperatures of the Russian Academy of Sciences, Moscow, Russia;

² Federal Research and Clinical Center of Specialized Medical Care and Medical Technologies FMBA of Russia, Moscow, Russia; e-mail: sitnik.ds@gmail.com

Application of THz radiation grows rapidly in both fundamental research and many practical areas (medicine, security, and military applications). Nevertheless, the question of its safety for living objects (ranging from single biomolecules and cells to whole organisms) is still a matter of controversy and requires further investigation. Official conclusion of the international project THz-BRIDGE (2001–2004) confirmed possible genotoxicity of THz radiation (in lymphocytes) as well as change in the permeability of liposome membranes under certain conditions, but it was not clear under which conditions such effects may arise.

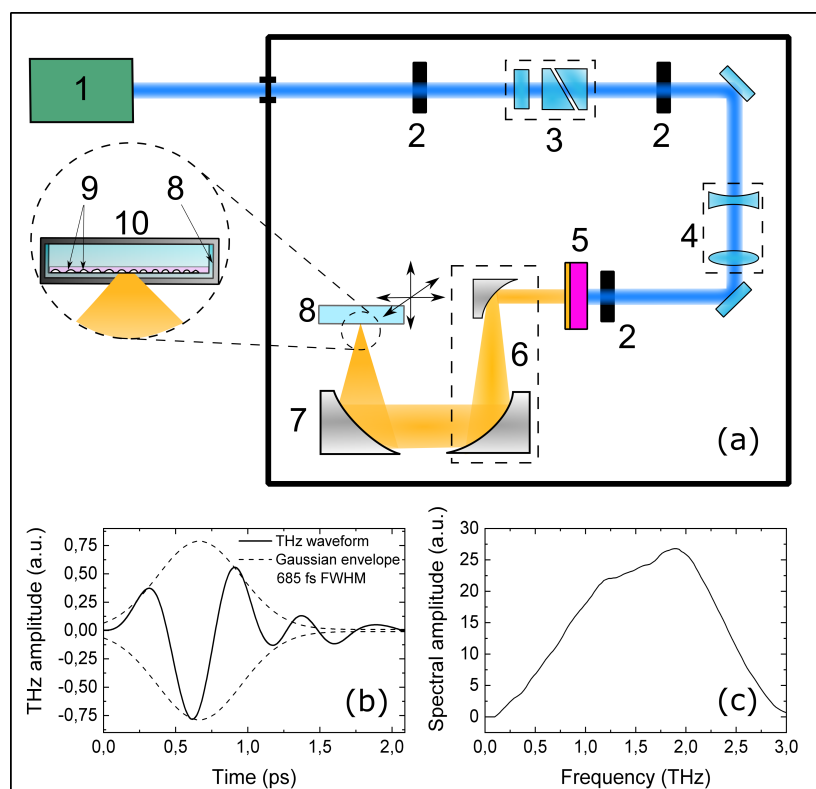

Figure 1: Experimental setup, 1 – source of femtosecond laser pulses, 2 – iris diaphragms, 3 – attenuation unit, 4 – lens telescope, 5 – THz OH1 crystal with filter, 6 – mirror telescope, 7 – focusing parabolic mirror, 8 – Petri dish, 9 – cells, 10 – stage incubator, (b) THz pulse waveform, (c) THz pulse spectrum.

RESULTS

Figure 1 (a) demonstrates the developed experimental setup for cell culture exposure to extreme electric field strengths to study possible adverse effects

on biological activity. Generation of THz radiation is performed via optical rectification of femtosecond pulses of infrared laser radiation (pulse duration of 100 fs, wavelength of 1240 nm) in the nonlinear organic OH1 crystal [1]. Femtosecond laser generates pulses with an energy of 1 mJ and a repetition rate of 100 Hz. OH1 crystal is about 5 mm in diameter, so laser beam passes the Galilean telescope to match crystal aperture and to get optimal laser fluence of 10 mJ/cm² on its surface. Conversion efficiency of laser to THz radiation is measured to be about 2%. THz radiation is focused to ~620 μm spot size (at e⁻¹ level) by 2" off-axis parabolic mirror (RFL=2") and directed through the bottom of the plastic dish. To estimate electric field strength in the focal plane of paraboloid, THz waveform measurement is performed (fig. 1 (b)) using electro-sampling technique. As can be seen in fig. 1 (c), a broadband pulse of THz radiation (spectrum width of 0.2–3 THz) of about 0.685 ps in duration FWHM is generated. Estimated field strength is about 3 MV/cm.

Petri dish or a plate with test cells is placed at 3D linear motorized stage setup. Our measurements have proven that various plastic dishes are transparent in frequency range under consideration so that THz pulses reach freely cell culture at the bottom of the dish. Since the size of the focused spot of THz radiation is several orders of magnitude smaller than the size of a standard 35-mm Petri dish, a sequential scanning mode of THz spot pathway is applied. To form the pathway, the dish is filled by a set of parallel lines, spacing between which equals THz spot diameter. To keep optimal cell temperature in the course of irradiation, the dish is placed into heating top stage incubator mounted at 3D stage setup

SUMMARY

Universal experimental setup for cell irradiation in either Petri dish or a multiwell plate is presented. It enables us to irradiate cells by high-intensity ultrashort broadband THz pulses with extreme field strengths of 3 MV/cm. Preliminary data on cell irradiation are obtained.

REFERENCES

- [1] A. Ovchinnikov, O. Chefonov, D. Sitnikov, I. Il'ina, S. Ashitkov and M. Agranat, *Quantum Electron* 48 (6), 554 (2018).

Generalized nonlinear Schrödinger equations describing SHG of pulses containing a few cycles

V. A. Trofimov¹, S. V. Stepanenko¹ and A. V. Razgulin¹

¹ Lomonosov Moscow State University, Moscow, Russia;
e-mail: s.stepanenko@cs.msu.ru

An interaction of laser pulse with substance is a modern problem attracting an attention of many researches. The present study deals with the second harmonic generation (SHG) in a medium with a quadratic nonlinear response for the pulses containing a few cycles. For adequate description of propagation of such laser pulses in bulk material the nonlinear Schrödinger equation cannot be used. In this case for a single laser pulse propagation in a medium with cubic nonlinear response the new equation was derived in [1] by T. Brabec and F. Krausz and named as generalized nonlinear Schrödinger equations (GNSE). The main features of this equation are a presence of time derivative from nonlinear response of a medium and of mixed derivatives on time and spatial coordinates.

In the present study, we firstly derive the set of GNSEs, which governs SHG process for the pulses, containing a few cycles, in a medium with quadratic nonlinear response and obtain the corresponding conditions for their validity. Also, we propose a transform of the GNSEs to a form that does not contain derivatives from the nonlinear response of a medium as well as mixed derivatives. It allows us to derive the corresponding conservation laws (integrals of motion or invariants), which play essential role in laser pulse propagation. We showed that the energy conservation law is valid at certain conditions on the incident pulse spectra: the spectra have not to contain non-zero spectral amplitudes at two specific frequencies. Their zero-value amplitudes at the pulse propagation are provided by the spectral invariants. We derived also the Hamiltonian (the third invariant) of the problem. These invariants should be taken into account at least for developing of the conservative finite-difference schemes at computer simulation of the SHG problem.

REFERENCES

- [1] T. Brabec, F. Krausz, Phys. Rev. Lett., 78 (17), 3282–3285 (1997).

High Kerr nonlinearity of water in THz spectral range.

A. N. Tsyarkin¹, M. V. Melnik¹, M. O. Zhukova¹, I. O. Vorontsova¹,
S. E. Putilin¹, S. E. Kozlov¹, X. C. Zhang^{1,2}

¹ International Laboratory of Femtosecond Optics and Femtotechnologies, ITMO University, St. Petersburg, 197101, Russia;

² The Institute of Optics, University of Rochester, Rochester, NY 14627, USA;
e-mail: tsypkinan@mail.ru

Nowadays, there are sources of the broadband pulsed THz radiation of such a high intensity, that it gets possible to observe nonlinear effects in the spectral range mentioned. However, the measurements of nonlinearities of material properties in THz region are carried out indirectly in most cases. This presentation will give an overview on the observation of the nonlinearities in the THz spectral range made by different research groups and then introduce new results, both experimental and analytical, on direct measurements of third-order nonlinearities of the material response in the broadband THz range obtained in our Laboratory.

Firstly, the talk will cover the generation of broadband high-intensity THz radiation. The standard techniques to get the latter are photo-conductive antennas (PCA), difference frequency generation (DFG), optical rectification (OR) in crystals or plasma generation in gases. The progress made in the sphere of high-intensity broadband sources of THz radiation allows to achieve the peak intensity of THz pulse around $1.1 \cdot 10^{13}$ W/cm² nowadays [1].

Such big values cause the nonlinear response of the media, which open new directions for a lot of applications to develop and stir up the interest to the observations of nonlinearities in THz frequency. Some works, demonstrating indirect measurements of material properties (the nonlinear optical response, the nonlinear free-carrier response) will be presented.

The next set of works to discuss will be about the direct characterization of the third-order nonlinearity of material response. The most important parameter characterizing the latter in the field of intense waves is the coefficient of its nonlinear refractive index n_2 . To measure it and some other material properties the Z-scan technique is widely used. The method is based on the self-focusing effect with the media acting like a focusing lens. Usually, the Z-scan technique is strictly valid for quasi-monochromatic radiation only. However, it is also often utilized in the case of femtosecond pulsed radiation that possesses a broad spectrum. Our research team presents the direct measurement of water nonlinear refractive index coefficient for the broadband pulsed THz radiation with the conventional Z-scan method. Since the Z-scan method works with plane-parallel samples only, at water jet was used. The experimental setup for measuring n_2 of a liquid jet is based on TERA-AX source of THz radiation. Flat water

jet is moved along the caustic area using a motorized linear translator. It has a thickness of 0.1 mm and is oriented along the normal to the incident radiation.

For n_2 determination Z-scan curves measured with closed aperture are used. The direct measurement of the nonlinear refractive index coefficient $n_2 = 7 \cdot 10^{10}$ cm²/W of water in the THz frequency range is shown, which is 6 orders of magnitude higher than for the visible and IR ranges [2]. These results are consistent with the theoretical estimate, made according to the method from the work [3]. They agree well with the experiment. Therefore, in terms of applications, our demonstration opens new perspectives for studying various materials in the THz frequency range. Nonlinear optics, in its turn, finds applications in the creation of light modulators, transistors, switches, and others in this spectral range.

REFERENCES

- [1] M. Shalaby, C. Hauri, Nature Communications, 6, 5976 (2015);
- [1] A. Tcypkin, M. Melnik, M. Zhukova, I. Vorontsova, S. Putilin, S. Kozlov, X. Zhang, Optics express, 27 (8), 10419-10425 (2019);
- [3] K. Dolgaleva, D. Materikina, R. Boyd, S. Kozlov, Physical Review A., 92 (2), 023809 (2015).

Simulations of terahertz emission from gas optical breakdown: a scheme with crossed domains for optical and terahertz fields

D. A. Urgapov¹, I. A. Nikolaeva¹, D. E. Shipilo^{1,2},
 N. A. Panov^{1,2} and O. G. Kosareva^{1,2}

¹Physics Faculty and International Laser Center, M. V. Lomonosov Moscow State University, Moscow, Russia

²P. N. Lebedev Physical Institute of Russian Academy of Sciences, Moscow, Russia
 e-mail: schipilo.daniil@physics.msu.ru

The simulations of terahertz (THz) emission from an air plasma induced by two-color femtosecond laser field is a computational task that reveals the full power and abilities of Unidirectional Pulse Propagation Equation (UPPE) [1]. The nonparaxiality of propagation at angles up to 85° to the optical axis, the spread of the electric field spectrum from sub-tera- to petahertz are handled with for the cost of excellent resolution both in real $t-x$ (or $t-r$) and frequency-angular $\omega-\theta$ domains, which require huge computational resources. Two pioneer works in this field perfectly illustrate the frustrating dichotomy: one can either simulate $(t, x, y) + z$ task and limit himself to tiny beam sizes that are far from experiments [2] or reproduce the experimental beam size and focusing but work with axially symmetrical $(t, r) + z$ case only [3].

In this work, we propose a scheme with Crossed Domains for Optical and Terahertz fields (XDOT) that utilize the difference in properties of laser field that induce optical breakdown and terahertz field emitted therefrom. The first one propagates almost paraxially and has a limited duration surely within 1-ps window in moving reference frame. The second one, terahertz field, has a duration of several picoseconds and wideangle divergence. In spectrum, these fields are separated by an extreme dip, at least for the pump pulses longer than 10 optical cycles. So, the partially overlapped temporal and spatial grids can be applied for carrying optical and terahertz field. The “optical” grid has a limited temporal and spatial domain (thus, poor frequency-angular resolution), but allows to fully reproduce the evolution of optical pump pulse with all its harmonics and the features accompanying femtosecond filamentation. The “terahertz” grid requires excellent resolution in frequency-angular domain but not in the real one, as it deals with “slow” oscillations of terahertz field. For the calculation of the source term (third-order polarization and transient photocurrent), which is local in space, the fields are combined on the superior grid with high temporal and frequency resolutions. After source term is calculated, it is adjusted to “optical” and “terahertz” grids separately and used in two propagation equations that are solved synchronously along the propagation coordinate.

We have verified the validity of proposed XDOT scheme for the axially symmetrical scheme where it can be directly compared to the primal approach with

the “mutual” grid. In our realization, a factor of 8 reduction of required rapid access memory was achieved. For arbitrary (x, y) beam distribution (including regularized beams), the use of XDOT will allow to simulate terahertz generation from laser plasma with a good angular and frequency resolution requiring only about 64–128 GByte RAM initialized.

This work was supported by the Russian Foundation for Basic Research (Grants 18-52-16020, 18-32-01000, 18-02-00954).

REFERENCES

- [1] M. Kolesik and J. V. Moloney, Phys. Rev. E 70, 036604 (2004).
- [2] L. Bergé, S. Skupin, C. Kohler, et al., Phys. Rev. Lett. 110, 073901 (2013).
- [3] V. Andreeva, O. Kosareva, N. Panov, et al., Phys. Rev. Lett. 116, 063902 (2016).

Study of backward terahertz emission from two-color laser induced microplasma

A. A. Ushakov^{1,2}, P. A. Chizhov¹, N. A. Panov^{2,3}, D. E. Shipilo^{2,3},
V. V. Bukin¹, A. B. Savel'ev², O. G. Kosareva^{2,3,4} and S. V. Garnov¹

¹ Prokhorov General Physics Institute of the Russian Academy of Sciences, Moscow, Russia;

² Faculty of Physics and International laser Center of Lomonosov Moscow State University, Moscow, Russia;

³ Lebedev Physical Institute of the Russian Academy of Sciences, Moscow, Russia;

⁴ Institute of Modern Optics, Nankai University, Tianjin, China

e-mail: ushakov.aleksandr@physics.msu.ru

Femtosecond laser plasma in gas media is one of the promising sources of terahertz (THz) radiation for different applications [1]. To achieve high power THz pulses in these sources two-color femtosecond pulses is typically used [2]. One of the key research directions for these sources is investigation of output angular distribution of THz emission in terms of focusing regime of two-color pump pulses [3]. A special interest is connected with tight focusing regime, which leads to forming of a microplasma source [4]. For these sources output angular distribution of THz emission is broad, and there is some part of THz emission that can spread from induced by two-color pulses microplasma in backward direction, that has been demonstrated experimentally [5].

In this work we investigate experimentally the properties of “backward“ THz emission from microplasma induced by two-color femtosecond laser pulses: waveform, spectrum and energy. By the controlled reflection of the spreading in forward direction THz emission, we observe “backward“ and “forward“ THz emissions in the same waveform and thus evidenced of the existence of “backward“ THz emission. The comparative spectral analysis of “backward“ and “forward“ THz emission is demonstrated. A shift of maximum in low-frequency region for “backward“ THz emission in comparison with “forward“ one is observed. Measurements of the energy of “backward“ and “forward“ THz emissions provide its ratio to be $\sim 5.5\%$ in terms of two-color pump energies in region 1.2-2 mJ. All of these results are in good agreement with numerical simulations in the framework of interferometric model [6].

REFERENCES

- [1] X.-C. Zhang, J. Xu, Introduction to THz Wave Photonics, Springer (2010).
- [2] D. J. Cook, R. M. Hochstrasser, Opt. Lett. 25 (18), 1210 (2000)
- [3] A. A. Ushakov et al., Opt. Express 26 (14), 18202-18213 (2018).
- [4] A. P. Shkurinov et al., Phys. Rev. E 95 (4), 043209 (2017).
- [5] A. A. Ushakov et al., JETP Lett. 106 (11), 706-708 (2017).
- [6] N. A. Panov et al., JETP Lett. 93 (11), 638-641 (2011).

Third-harmonic generation in silicon nanowire ensembles

A. S. Ustinov, N. B. Tkachenko, L. A. Osminkina, S. V. Zaboltnov and
L. A. Golovan

Physics Department, M.V. Lomonosov Moscow State University, Moscow, Russia
e-mail: lexa97.ustinov@yandex.ru

An important direction of modern photonics is the study of metamaterials - artificial media formed by particles, whose dimensions are comparable with the wavelength in the medium. The use of materials with a high refractive index allows the concentration of the electromagnetic wave field in the particle as well as strong light scattering accompanied by a significant increase in the photon lifetime in such a medium. The interaction of these two effects is of great interest.

Arrays of silicon nanowires (SiNWs) of about 100 nm in diameter and of 0.1 to 100 μm in length are of great interest because of their unusual optical properties: almost complete absorption of visible radiation, a high reflection in the near infrared range, increase in the Raman scattering and interband photoluminescence efficiencies [1]. These effects are explained by the photon lifetime increase in SiNW arrays due to strong light scattering in them [2]. On the other hand, the size of SiNWs allows considering their arrays as a dielectric metamaterial [3].

To reveal correlation of the structural and optical properties of the SiNW arrays we studied the third-harmonic (TH) generation in them. The SiNW arrays were formed at (110) crystalline silicon, with the SiNWs being inclined at 45° to the substrate surface. Cr:forsterite laser radiation (1250 nm, 80 fs, 150 mW, 80 MHz) was employed to pump the TH.

The TH generation efficiency and TH orientational dependences are significantly conditional on the pump radiation incidence: along the SiNWs or perpendicular to them. In the latter case, the TH signal is several times higher. Difference between the TH signals pumped by right and left circular polarizations was found; thus, achiral SiNW arrays demonstrate circular dichroism. The sign of the chirality reverses by switching the direction of the wires from upward to downward, consequently demonstrating extrinsic nature of chirality. Despite strong light scattering by SiNW arrays and its depolarization, TH signal demonstrates its appreciable anisotropy. The efficiency of TH generation increases with increasing thickness of the SiNWs layer. The observed effects are due, on the one hand, to light scattering in SiNWs arrays and, on the other hand, to the orientation of the SiNWs along one direction. Thus, it is shown that the TH generation is sensitive to the local fields inside the elements of the scattering medium.

REFERENCES

- [1] L. A. Osminkina et al., *Nanoscale Research Lett.* 7, 524 (2012).

- [2] A. Efimova et al., *Optical and Quantum Electronics* 48, 232 (2016).
- [3] S. Jahani, Z. Jacob, *Nature Nanotechnology* 11, 23 (2016).

The spectral characteristics of picosecond SRS in the water at the boundary of "water-air"

A. I. Vodchits¹, I. A. Khodasevich¹, V. A. Orlovich¹ and S. M. Pershin²

¹ B. I. Stepanov Institute of Physics of National Academy of Sciences of Belarus, Minsk, Belarus;

² Prokhorov General Physics Institute of the Russian Academy of Sciences, Moscow, Russia;
e-mail: a.vodchits@dragon.bas-net.by

As many properties of water are not satisfactorily explained so far, their study is an actual problem in the present time. The efficient methods for studying the structure and properties of water are the optical methods of spontaneous Raman scattering and, especially, stimulated Raman scattering (SRS) of laser radiation exciting the water.

In this report, we submit the results of studying the spectral characteristics of SRS in water near the boundary of "water-air". In the experiment, 57 ps laser pulses at 532 nm were used for the excitation of water. Laser beam was focused with a lens of 100 mm focal length into the open cell with bi-distilled water. Optical scheme with the vertical geometry was applied. Focal waist of the exciting beam was shifted in the direction to the boundary of "water-air" starting from the point in water at a distance of about 23 mm from the boundary. SRS spectra of water have been measured in a number of positions of focal waist.

The results obtained show that the SRS spectrum of water is substantially changed at the boundary of "water-air". In the deep of water, the first Stokes component near 3400 cm^{-1} is observed with FWHM of about 65 cm^{-1} . Closing to the boundary, low-frequency shoulder on this component is appeared. Near the boundary, at a distance of 7 mm from it, the shoulder is almost disappeared, and the spectrum of the Stokes component is narrowed up to 53 cm^{-1} . At the boundary, the first Stokes component has unexpected structure – axial part with a ring around it. The spectrum of the first Stokes has two sub-components – high-frequency component (due to axial part) near 3430 cm^{-1} . and low-frequency component (due to ring) near 3000 cm^{-1} . Some physical mechanisms of these new effects (interference of vibration and libration Raman active modes, self-focusing, laser induced plasma) are discussed.

Financial support of the Belarusian Republican Foundation for Fundamental Research (Project F18R-036) and Russian Foundation for Basic Research (Project 18-52-00038 Bel-a) is gratefully acknowledged.

Scenario of light bullet formation under different axicon focusing

E. D. Zaloznaya^{1,2}, A. E. Dormidonov^{1,2}, S. V. Chekalin², V. O. Kompanets²,
V. P. Kandidov^{1,2}

¹ Faculty of Physics and International Laser Center, M.V. Lomonosov Moscow State University, Moscow, Russia;

² Institute for Spectroscopy Russian Academy of Sciences, Troitsk, Moscow, Russia;
e-mail: ed.zaloznaya@physics.msu.ru

Filamentation of femtosecond infrared radiation under conditions of anomalous group velocity dispersion ($k_2 = \partial^2 k / \partial \omega^2 < 0$) is accompanied by the formation of a high-intensity extremely compressed wave packet – a light bullet (LB). The formation of LB, which duration can be one or two oscillations of the light field, occurs due to compression of wave packet (WP) in space and time [1].

In this paper we investigate the process of LB formation in a Gaussian beam of femtosecond radiation focused by conical lens – axicon. Beam propagating through the axicon acquires spatial phase modulation, which causes the transformation of a plane wave front to a conical one. The interference of generated conical waves leads to the Bessel-Gaussian intensity distribution in the cross-section of a beam [2]. The length of the interference area and the distance before the formation of Bessel-Gaussian beam Z_{Bess} depend on the conical wave front's convergence angle, which in turn determines by the base angle of the axicon. In this regard, it is of interest to investigate the influence of the axicon focusing sharpness on the LB formation scenario, the length of induced plasma channels and the occurrence of features in the supercontinuum spectrum.

The filamentation of femtosecond wave packet in SiO₂ at a wavelength of 1900nm, focused by the axicon under variation of base angle from 0.5° to 15° was studied numerically.

Depending on the ratio between Z_{Bess} and Z_{Marb} several different regimes of femtosecond filamentation were identified. In the case $Z_{Marb} > A_{ax} * Z_{Bess}$, where the parameter $A_{ax} = 1.5 \div 3$, filamentation occurs simultaneously with the formation of Bessel-Gaussian beam. And the generation of light bullet is in the central lobe of Bessel-Gaussian structure.

If $Z_{Marb} < A_{ax} * Z_{Bess}$, self-focusing prevails the formation of Bessel-Gaussian beam and the generation of a light bullet prevents the occurrence of the ring Bessel structure in the beam.

If $Z_{Marb} \gg Z_{Bess}$, Bessel-Gaussian beam is formed before the generation of light bullet. In this case, the peak power in the central lobe may be lower than the critical self-focusing power and, as a result, there is no filamentation and LB formation.

This work was supported by the Russian Science Foundation (Project No. 18-12-00422). Zaloznaya E.D. acknowledges foundation for the advancement of theoretical physics and mathematics “BASIS“ for the financial support.

REFERENCES

- [1] Silberberg Y., Opt. Lett. (22). P. 1282-1284 (1990).
- [2] Pyatnitskii L.N. Wave Bessel Beams (Moscow: Fizmatlit, 2012).

Ultrafast nonlinear optics in the mid-infrared: Expanding the realm of optical physics

A. Zheltikov^{1,2,3}

¹Physics Department, International Laser Center, M. V. Lomonosov Moscow State University

² Department of Physics and Astronomy, Texas A&M University

³ Russian Quantum Center

e-mail: zheltikov@physics.msu.ru

Motivated and driven by numerous applications and long-standing challenges in strong-field physics, molecular spectroscopy, semiconductor electronics, and standoff detection, ultrafast optical science is rapidly expanding toward longer wavelengths. Recent breakthroughs in mid-IR laser technologies enable the generation of few- and even single-cycle mid-infrared field waveforms with peak powers ranging from a few megawatts to hundreds of gigawatts within a broad range of central wavelengths. Experiments with such sources of ultrashort pulses in the mid-IR help understand complex interactions of high-intensity ultrashort mid-IR pulses with matter, giving rise to unique regimes of laser-matter interactions and revealing unexpected properties of materials in the mid-infrared. High-power mid-IR soliton transients and laser filaments in air demonstrated in recent experiments set new milestones in the 1000-year history of atmospheric optics, opening new horizons in high-power laser signal transmission and remote sensing of the atmosphere. Below-the-bandgap high-order harmonics generated by ultrashort mid-infrared laser pulses are shown to be ideally suited to probe the nonlinearities of electron bands, enabling an all-optical mapping of the electron band structure in bulk solids.

Our experiments show that, in the mid-infrared range, due to the λ^{-2} scaling of I_{rel} with the driver wavelength λ , relativistic HHG can be observed at much lower levels of laser field intensities. High-peak-power 80-fs, 3.9- μm pulses are focused in our experiments on a solid surface to provide field intensities in the range of 10^{17} W/cm². Remarkably, this level of field intensities, considered as low by the standards of relativistic optics in the near-infrared, is shown to be sufficient for the generation of high-order harmonics with signature properties of relativistic HHG – beam directionality, spectra with extended plateaus, and a high HHG yield sustained for both p- and s-polarized driver fields.

Ultrabroad UV-to-MMW-band spectral measurements performed jointly with direct timedomain field-waveform characterization show that the nonlinear response of a fast-ionizing gas driven by a two-color mid-IR field provides a source of a bright multiband supercontinuum radiation, spanning over about 14 octaves, stretching from below 300 nm in the UV all the way beyond 4.3 mm in the MMW band. The MMW-to-THz part of this supercontinuum is emitted, as direct pulse and beam characterization along with absolute power measurements

show, in the form of half-cycle field waveforms that can be focused to yield a field strength of $\simeq 0.5$ MV/cm. At least 1.5% of the MMW–THz supercontinuum energy is emitted in the MMW range, giving rise to MMW field strength up to 10 kV/cm in the beam-waist region.

This talk will offer an overview of recent discoveries in this field of research, which lead us to rethink the limits of the rapidly expanding realm of nonlinear optical physics.

Superradiance pulse generation by molecular nitrogen ions in atmospheric filament

I. A. Zyatikov, V. F. Losev, and V. E. Prokopev

Institute of High Current Electronics SB RAS, 2/3 Akademichesky Avenue, 634055, Tomsk,
e-mail: werop@sibmail.com

Lasing of nitrogen molecules and its ions in plasma filament by pumping an intense ultrashort laser pulse has attracted much attention in recent years [1-3]. The cavity-free generation of coherent radiation holds great potential for remote sensing applications. A coherent superradiance (SR) at wavelength of 391.4 and/or 427.8 nm was observed in forward direction by focusing femtosecond laser pulse at 0.8-1 μm in ambient air or pure nitrogen. However, the physical mechanisms of population inversion creation and generation in plasma filament remain controversial.

In this work, the experimental results of investigation of temporal, spatial, and spectral characteristics of SR at $B^2\Sigma_u^+ - X^2\Sigma_g^+$ transition of molecular nitrogen ions were presented. Pumping was carried out by femtosecond laser pulse at wavelength of 950 nm. For the first time, the actual duration of SR pulse (600 fs) at $\lambda = 428$ nm was measured. This pulse duration is transform-limited according to the measurements of spectral width (0.3 nm). It was shown, that there was a delay of SR pulse maximum relative to pumping by ~ 7 ps. SR propagates in the form of hollow cone, which confirms the influence of supercontinuum on this radiation.

The reported study was funded by RFBR according to the research projects N 19-48-703027 r-youth-a and N 19-48-700016 r-a.

REFERENCES

- [1] X. Zhong, Z. Miao, et al., Phys. Rev. A. 96, 043422 (2017).
- [2] J. Yao, W. Chu, et al., Appl. Phys. B. 124, 72 (2018).
- [3] N. G. Ivanov, V. F. Losev, et al., Opt. Commun. 431, 120 (2019).

Section 5: Femtosecond laser photobiology and photochemistry

Section Chair:

Sergey Chekalin, e-mail: chekalin@isan.troitsk.ru
(Institute of Spectroscopy, Russia)

Program committee:

Andrei Razjivin
(Moscow State University, Russia)

Ivan Pozdnyakov
(Voevodsky Institute of Chemical Kinetics and Combustion, Russia)

Evegeny Ryabov
(Institute of Spectroscopy, Russia)

Scope

Applications of Femtosecond spectroscopy in Chemistry and Physics
Ultrafast dynamics in molecules and clusters
Ultrafast phenomena in Biophotonics and Photobiology
Ultrafast spectroscopy of primary processes of photosynthesis

Primary photophysical and photochemical processes for platinum metal complexes prospective in photochemotherapy of tumors

E. M. Glebov^{1,2}, I. P. Pozdnyakov^{1,2}, A. A. Melnikov^{3,4} and S. V. Chekalin³

¹ V.V. Voevodsky Institute of Chemical Kinetics and Combustion, Novosibirsk, Russia;

² Novosibirsk State University, Novosibirsk, Russia;

³ Institute of Spectroscopy RAS, Troitsk, Moscow, Russia;

⁴ Faculty of Physics, National Research University Higher School of Economics, Moscow, Russia

e-mail: glebov@kinetics.nsc.ru

Photochemotherapy is a prospective method of anti-cancer treatment based on phototransformations of platinum metals complexes. In comparison with traditional photodynamic therapy based on triplet sensitizers, photochemotherapy does not need dissolved oxygen. It is important because many tumors are hypoxic. In spite of practical importance, the fundamental photochemistry of potential anti-cancer complexes typically is not known in detail. Combining steady-state and time-resolved methods of photochemistry, one can hope to establish the mechanisms of photolysis, which can help in understanding the nature of therapeutic action.

We will consider photochemistry of several platinum metals complexes in the time range from hundreds of femtoseconds to seconds. The complexes under discussion are: (1) $OsCl_6^{2-}$ as a simple model system [1]; (2) mixed-ligand diiodido [2] and diazido [3] complexes of Pt(IV), which light-induced cytotoxicity is based on Pt(IV) photoreduction; (3) simple Ru(II) complexes, which light-induced cytotoxicity is based on reactions of photochemical aquation / rearrangement.

The work was supported by the Russian Science Foundation (grant N 18-13-00246).

REFERENCES

- [1] E.M. Glebov, I.P. Pozdnyakov, S.G. Matveeva, A.A. Melnikov, S.V. Chekalin, M.V. Rogozina, V.V. Yudanov, V.P. Grivin, V.F. Plyusnin, *Photochem. Photobiol. Sci.*, 16 (1), 220 (2017).
- [2] E.M. Glebov, I.P. Pozdnyakov, D.B. Vasilchenko, A.V. Zadesenets, A.A. Melnikov, I.M. Magin, V.P. Grivin, S.V. Chekalin, V.F. Plyusnin, *J. Photochem. Photobiol. A: Chem.*, 354, 78 (2018).
- [3] A.A. Shushakov, I.P. Pozdnyakov, V.P. Grivin, V.F. Plyusnin, D.B. Vasilchenko, A.V. Zadesenets, A.A. Melnikov, S.V. Chekalin, E.M. Glebov, *Dalton Trans.*, 46 (29), 9440 (2017).
- [4] S.G. Matveeva, A.A. Shushakov, I.P. Pozdnyakov, V.P. Grivin, V.F. Plyusnin, D.B. Vasilchenko, A.V. Zadesenets, A.A. Melnikov, S.V. Chekalin, E.M. Glebov, *Photochem. Photobiol. Sci.*, 17 (9), 1222 (2018).

Non-coherently controlled chemical modifications of biomolecules by ultrashort laser pulses in polar liquids

V. E. Gruzdev¹, D. Korkin², B. P. Mooney^{3,4,7}, J. F. Havelund^{5,6}, I. M. Møller⁵
and J. J. Thelen^{4,7}

¹ Department of Physics and Astronomy, University of New Mexico, Albuquerque, NM, USA;

² Department of Computer Science, Bioinformatics & Computational Biology Program, Worcester Polytechnic Institute, Worcester, MA, USA;

³ Charles W Gehrke Proteomics Center, University of Missouri, Columbia, MO, USA;

⁴ Department of Biochemistry, University of Missouri, Columbia, MO, USA;

⁵ Department of Molecular Biology and Genetics, Aarhus University, Slagelse, Denmark;

⁶ Present address: Department of Biochemistry and Molecular Biology, University of Southern Denmark, Odense , Denmark;

⁷ Christopher S. Bond Life Sciences Center, University of Missouri, Columbia, MO, USA;

e-mail: vgruzdev@unm.edu

Ultrashort laser pulses can coherently control photosensitive biomolecules confined in a condensed matrix [1]. However, the control of non-photosensitive biomolecules was not performed in biologically relevant environment because of the strong biomolecule-environment interaction [2]. This fundamental challenge is approached by control of permanent laser-assisted chemical modifications of non-photosensitive biomolecules under the biologically relevant conditions [3].

REFERENCES

[1] N. Lambert, et al, Nature Physics 9, 10 (2013).

[2] P. van der Walle, et al, Proc. Natl. Acad. Sci. USA 106, 7714 (2009).

[3] V. Gruzdev, et al, Sci. Rep. 7, 5550 (2017).

Non-equilibrium effects in ultrafast photoinduced intramolecular charge transfer

A. I. Ivanov¹, A. E. Nazarov¹ and R. E. Malykhin¹

¹Volgograd State University, Volgograd, Russian Federation
e-mail: Anatoly.Ivanov@volsu.ru

Ultrafast charge transfer (CT) plays a determining role in photosynthesis, catalysis, dye-sensitized solar cells and various molecular electronic devices. It typically proceed in non-equilibrium conditions that are created by a pump pulse or a preceding photoreaction. Although the microscopic mechanisms of many photoreactions was clarified, control of the rate and efficiency of CT is still an unanswered challenge. One of the unsolved problems is suppression of ultrafast charge recombination (CR). In such systems CR is undesirable process, leading to the loss of energy and selectivity of photoreaction. In this report some strategies of ultrafast CR suppression are discussed.

The non-equilibrium nature of ultrafast CT manifests itself in unusual kinetic regularities. The most known manifestations of the non-equilibrium character of CR are: (i) the absence of the Marcus normal region in the free energy gap law, (ii) low quantum yield of the thermalized charge separated states in ultrafast CT from the second excited state, (iii) breaking the Ostwald's principle of the independent course of elementary reactions, and (iv) dependence of the kinetics of a given stage on characteristics of previous stages. Knowledge of the CT regime is needed to control such reactions because the kinetics and yield of products of non-equilibrium reactions demonstrate regularities that significantly differ from those observed in thermal reactions.

In this report we discuss a number of examples demonstrating strong differences in regularities inherent to CT reactions occurring in the non-equilibrium and thermal regimes. Among them the dependencies of the dynamic solvent effect (influence of the solvent viscosity on the CR rate) on the CR free energy gap in photoexcited donor-acceptor complexes in polar solvents is shown to be opposite for thermal and non-equilibrium reactions.

For two-stage and multi-stage CT, the kinetics strongly depends on the angles between the reaction coordinates corresponding to the individual stages. The results of investigations of photoinduced charge separation in the supramolecular system with several centres of electron localization are also presented. It is shown that the secondary acceptor can considerably increase the yield of the charge separated states provided the parameters controlling the charge transfer are precisely adjusted. An examples are presented how to maximize the quantum yield of charge separated state in ZPn/imide-based triads. This requires that the radius of the secondary acceptors should be rather large, the secondary acceptor

should be arranged at close distance to the primary acceptor, and the energetic parameters of the triad also should be well tuned.

The study was performed by a grant from the Russian Science Foundation (Grant No. 16-13-10122)

Influence of fluorinated chain length on energy transfer processes of Eu^{3+} β -diketonate complexes

V. M. Korshunov¹, S. A. Ambrozevich¹, V. O. Kompanets², A. A. Melnikov²,
I. V. Taidakov¹ and S. V. Chekalin²

¹ Lebedev Physical Institute of the Russian Academy of Sciences, Moscow, Russia;

² Institute of Spectroscopy of the Russian Academy of Sciences, Moscow, Russia;

e-mail: korshunovvm@lebedev.ru

Coordination compounds of trivalent lanthanide ions with organic β -diketonate ligands [1] are promising materials for fabrication of active layers in organic light emitting diodes (OLEDs). Efficiency of the OLEDs is mostly determined by luminescence quantum yield (QY) of these active layers. It is known that extension of fluorinated chain length of β -diketonate ligands in the lanthanide complexes can improve luminescence QY since CF bonds have lower vibrational energy, thus, reducing the effect of quenching [2]. However, dependence of QY on the length of fluorinated chain has more complicated behavior. Indeed, the quantum yield reaches saturation at 50–60% for the complexes with excessively long chains [3]. This phenomenon still has no explanation in the literature. In order to reveal the processes responsible for observed QY saturation it is essential to investigate excitation energy relaxation processes in ligand environment by means of ultrafast spectroscopic studies.

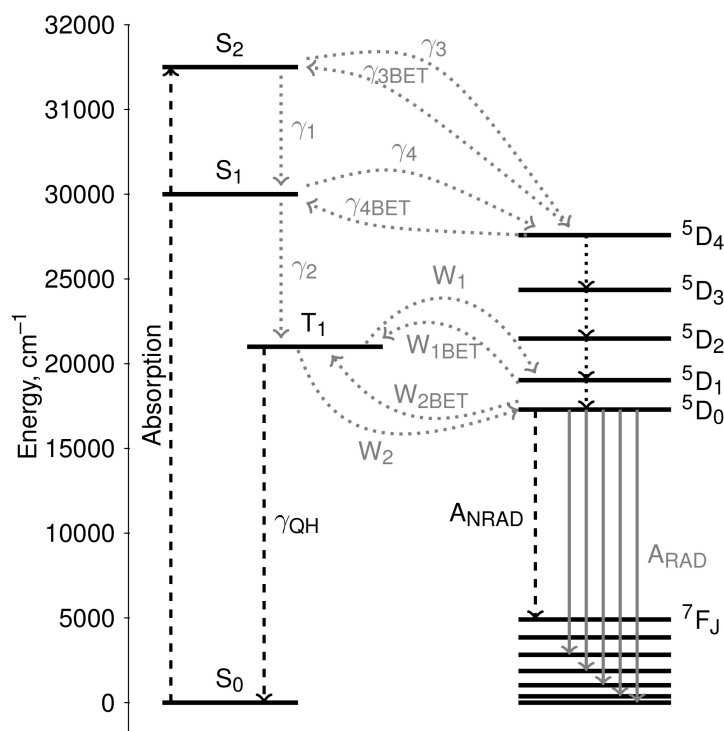

Figure 1: Energy level diagram of investigated complexes.

In present work we perform ultrafast spectroscopy (transient absorption measurements, TA) experiments using femtosecond laser pulses. On the basis of the

performed experiments combined with theoretical calculations in the framework of Sparkle model we determine energy transfer rates in four europium complexes having 3, 4, 7, and 13 fluorine atoms in the chain.

One of the goals of present work is to develop energy level diagram (see Fig. 1) accounting for the energy transfer and relaxation processes in the investigated complexes. We demonstrate that the extension of the fluorinated chain length in the β -diketonate ligand strongly affects the energy structure of the ligand environment. With the use of approach considered above we obtain a complete set of radiative and nonradiative transition rates in the complexes. The developed relaxation model appears more complicated as compared to the conventional Jablonski-Crosby diagram taking into consideration only one singlet and triplet level of the ligand environment.

The synthetic and analytical parts of the work were supported by the Russian Science Foundation under project 17-72-20088. Spectral measurements were funded by the Russian Foundation for Basic Research under project 18-02-00653-a.

REFERENCES

- [1] Weissman S. I. Intramolecular Energy Transfer The Fluorescence of Complexes of Europium // J.Chem. Phys.V.10 No4, 214-218 (1942). [2] A. Beeby, I. Clarkson, R. Dickins, S. Faulkner, D. Parker, L. Royle, 18A. de Sousa, J. Williams, M. Woods, J. Chem. Soc., Perkin Trans 2 (2), 493 p (1999). [3] E. A. Varaksina, A. G. Vitukhnovsky, N. P. Datskevich, I. V. Taidakov, S. A. Ambrozevich. Experimental Determination of Energy Transfer in Eu(III) Complexes Based on Pyrazole-Substituted 1, 3-Diketones, Journal of Russian Laser Research, 36 (6), 602-607 (2015).

The solvent effect on ultrafast photochemistry of copper(II) halide complexes.

A. S. Mereshchenko¹, A. N. Tarnovsky², and J. Hunger³

¹ Saint-Petersburg State University, Saint-Petersburg, Russia;

² Bowling Green State University, Bowling Green, OH, USA;

³ Max Planck Institute for Polymer Research, Mainz, Germany;

e-mail: a.mereshchenko@spbu.ru

The role of the solvent medium in the photochemistry and photophysics cannot be underestimated. The solvent affects the topology of potential energy surfaces, initially occupancy of vibrational modes, vibrational relaxation and energy redistribution phenomena. The structure and relative energy of reagents, products and transition states as well as the interconnecting paths often depend from the solvent. Also, the solvent molecule can be involved in photochemical reaction as well as in electron and energy transfer processes. In this work, we have demonstrated the solvent effect of the photochemical and photophysical processes in copper(II) halide complexes.

The solvent molecules play important role in complex formation as ligands. For copper(II) halide complexes, the donor ability of the solvent significantly affects on the thermodynamics and the kinetics of complex formation. Thus, the stability constants of copper(II) halide complexes are larger in solvents with weaker donor ability [1]. The solvent in also determines the ligand exchange dynamics. We have demonstrated that mechanisms and dynamics of formation of tetrahalide copper(II) complexes from trihalide copper(II) complexes and halide ions are different in acetonitrile and in dichloromethane due to differences in donor properties of the solvent [2].

The solvent also can interact with excited state species as an excited state quencher. Thus we have demonstrated that the lifetime of the $^2A^1$ d-d excited states of CuCl_4^{2-} and CuBr_4^{2-} complexes are similar in anhydrous acetonitrile, dichloromethane and chloroform. However, the addition of water or alcohols to acetonitrile solution of copper(II) tetrahalide complexes efficiently quenches the d-d excited states due to the efficient electronic-to-vibrational energy conversion resulting in excitation of O-H stretching modes of the outer-shell water/alcohol molecules [3]. Using NIR-pump/IR-probe transient absorption spectroscopy, we have monitored sub-picosecond energy transfer from LF-excited copper(II) complexes to outer-shell water/alcohol followed by energy transfer to bulk water/alcohol molecules.

REFERENCES

[1] P.K. Olshin et al., Chem. Phys. 503, 14-19 (2018).

[2] A.S. Mereshchenko et al., J. Phys. Chem. B. 121, 4562-4568 (2017).

[3] A. S. Mereshchenko et al., J. Phys. Chem. B. 119, 8754-8763 (2015).

Ultrafast laser interaction with plasmonic nanostructures and applications in nanomedicine

M. Meunier

Department of Engineering Physic, Laser Processing and Plasmonics Laboratory, Polytechnique
Montréal, Montréal, Québec, H3C 3A7
e-mail: michel.meunier@polymtl.ca

Irradiating metallic nanostructures by an ultrafast laser beam produces highly localised processes on the nanoscale in the surrounding medium. This particular process is mainly attributed to the surface plasmon resonance of the nanostructures. When these nanomaterials are colloidal nanoparticles, their irradiation by an ultrafast laser could result in a highly localized plasma, heat production, pressure wave in the liquid and finally nanocavitation around the nanoparticles [1-4]. In this invited talk, I will cover recent developments of fundamental aspects describing multiscale processes on the nanoscale as well as on ultra-short time (femtosecond to nanosecond). Multiphysics models based on electromagnetism, two-temperature model, thermodynamics and fluid dynamics have been developed to describe theoretically the productions of nanoplasma, pressure waves and nanocavitation. Models were successfully compared with experiments including shadowgraphy showing nanobubble dynamics and an all-optical pump-probe technique enabling the detection of plasmonic enhanced nanocavitation and pressure wave generation. We will also describe an *in-silico* rational design approach based on our theoretical modeling that optimizes cavitation without breaking the nanostructure. Using this framework, we demonstrate that nanoshells (NS) can significantly reduce the cavitation threshold in the near-infrared [5-7]. Applications are in nanomedicine [8-12] in which ultrafast laser irradiation of these nanoparticles located close to a living cell, can produce a nanosurgery [8-9], can stimulate neurons [10] or induce drug delivery [11-12]. These nanoparticles could be functionalized to target specific biological entities, thus performing multiple targeted surgeries on the nanoscale [8-9]. The laser nanosurgery technique was employed to perform gene transfection in living cancer cell with an optoporation efficiency as high as 80% [8-9]. In addition, this technique was used as an all optical method for simulating and monitoring neuronal activity, action potential and cell signaling in neurons [10]. Finally, the proposed new technique addresses the current void in efficient, cell-specific, retinal drug delivery systems. Recent *in vivo* experiments in rat eye model show that this new technique could be used to optoporate retinal ganglion cell using conjugated gold nanoparticles [11]. A provisional patent was recently submitted [12]. This non-viral gene therapy tool may provide a safe, cost effective approach to selectively target retinal cells. In conclusion, our laser technique shows promises as an innovative tool for fundamental research in biology and

medicine as well as an efficient alternative nanosurgery technology that could be adapted to therapeutic tools in the clinic.

REFERENCES

- [1] E. Boulais et al, Nanoletters, 12, 4763-4769 (2012);
- [2] E. Boulais et al, Journal of Photochemistry and Photobiology C, 17, 26-49 (2013);
- [3] R. Lachaine et al ACS Photonics, 1, 331-336 (2014);
- [4] A. Dagallier et al, Nanoscale 9 (9), 3023-3032, (2017);
- [5] R. Lachaine et al Nano letters 16, 3187 (2016);
- [6] R. Lachaine et al ACS Photonics. 3, 2158 (2016);
- [7] C. Boutopoulos et al Nanoscale 7, 11758 (2015);
- [8] J. Baumgart et al, Biomaterials, 33, 2345-2350 (2012)
- [9] E. Bergeron et al, Nanoscale, 7, 17836-17847 (2015);
- [10] F. Lavoie-Cardinal et al, Scientific Reports, 6, 20619 (2016).
- [11] A. Wilson et al, NanoLetters, 18 (11), 6981-6988 (2018).
- [12] M. Meunier et al, US Patent App. 16/168,982, (2019)

Dynamic solvent effect in photoinduced intramolecular proton-coupled electron transfer reactions

T. V. Mikhailova, V. A. Mikhailova and A. I. Ivanov

Volgograd State University, Volgograd, Russia
e-mail: mikhailova.tv@volsu.ru

The study of the dynamic solvent effect in photoinduced intramolecular proton-coupled electron transfer reactions occurring in non-equilibrium regime has been carried out. The influence of the angle between the reaction coordinates directions corresponding to the stages of photoexcitation and product formation on reaction kinetics was revealed in the framework of developed multichannel stochastic model [1]. The numerical simulation made it possible to establish a few regularities inherent in such reactions [2]: (1) the largest magnitude of the dynamic solvent effect is predicted to be observed in strong exergonicity region, and in the region of weak exergonicity the effect is small; (2) the maximum of the dependence of the rate constant of proton-coupled electron transfer on the magnitude of the reaction exergonicity shifts to a region of lower values with matrix element of the transition increasing; (3) the dependence of the effective reaction time on the angle between the reaction coordinates corresponding to the photoexcitation and the product formation directions has a pronounced minimum. Its position depends on the energy parameters of the reagents.

The study was performed by a grant from the Russian Foundation for Basic Research (Grant N 19-03-00175).

REFERENCES

- [1] T.V. Mikhailova, V.A. Mikhailova, A.I. Ivanov, *J. Phys. Chem. C* (122) 25247 (2018).
- [2] T.V. Mikhailova, V.A. Mikhailova, A.I. Ivanov, *Russ. J. Phys. Chem. A*. in press (2019).

Modeling kinetics of ultrafast photoinduced intramolecular proton-coupled electron transfer

V. A. Mikhailova, T. V. Mikhailova and A. I. Ivanov

Volgograd State University, Volgograd, Russia
e-mail: mikhailova.va@volsu.ru

A model of photoinduced intramolecular proton-coupled electron transfer is derived [1]. The model includes three states as follows: the ground, excited, and product states. A larger part of the model parameters can be extracted from the stationary absorption and fluorescence spectra of a particular fluorophore. Charge transfer is associated with both the photoexcitation and the product formation stage. Two different reaction coordinates are associated with the two stages, which are not independent. The angle between the reaction coordinates strongly influences on the kinetics of ultrafast product formation. The stochastic multichannel approach is exploited for simulations of the kinetics. The simulations well reproduce the experimental kinetics of ultrafast intramolecular proton-coupled electron transfer in 2-((2-(2-hydroxyphenyl)benzo[d]oxazol-6-yl)methylene) malononitrile in a few solvents [2]. The transfer is shown to occur totally or partly, depending on the solvent, in the nonequilibrium regime. Analysis of the kinetics of the excited-state decay has uncovered a significant decrease in the magnitude of the reorganization energies of slow nuclear modes with increasing the solvent polarity [1]. Such an unusual behavior of the total reorganization energy can be rationalized under the assumptions: (i) a slow intramolecular reorganization of a significant magnitude associates with the transition between excited and product states and (ii) intramolecular slow reorganization is accompanied by a change in the dipole moment of the fluorophore.

The study was performed by a grant from the Russian Science Foundation (Grant N 16-13-10122).

REFERENCES

- [1] T.V. Mikhailova, V.A. Mikhailova, A.I. Ivanov, *J. Phys. Chem. C* (122) 25247 (2018).
- [2] C.C. Hsieh, C.M. Jiang, P.T. Chou, *Acc. Chem. Res.* 43, 1364 (2010).

Ultrafast processes in photochemistry of natural photosensitizers

I. P. Pozdnyakov^{1,2}, A. A. Melnikov³, S. V. Chekalin³, V. F. Plyusnin^{1,2}

¹ Voevodsky Institute of Chemical Kinetics and Combustion, Novosibirsk, Russian Federation;

² Novosibirsk State University, Novosibirsk, Russian Federation;

³ Institute of Spectroscopy, Russian Academy of Sciences, Troitsk, Moscow, Russian Federation;
e-mail: pozdnyak@kinetics.nsc.ru

Photochemical processes playing important role in global cycles of organic nutrients in environment. Humic substances (HS, including humic and fulvic acids) and Fe(III) carboxylates are naturally photoactive components, which widely present in surface waters. These compounds are able to generate reactive oxygen species (ROS) under solar irradiation, which can react with dissolved organic pollutants initiating their degradation and mineralization. However initial stages of photophysics and photochemistry of HS and Fe(III) carboxylates which are responsible for further generation of ROS are still poor investigated. This talk presents results obtained by means of femtosecond kinetic spectroscopy with picosecond time resolution. Spectral and kinetic characteristics of HS excited singlet and triplet state have been obtained for the first time. Relation of these properties with efficiency of ROS generation is discussed.

The work was financially supported by Russian Foundation for Basic Research (grants N 17-03-00252, 18-53-53006-GFEN)

Free and bound Thioflavin T molecules with ultrafast relaxation: implications for assessment of protein binding and aggregation

N. R. Rovnyagina¹, T. N. Tikhonova², V. O. Kompanets³, E. A. Shirshin^{1,3}
and G. S. Budylin⁴

¹ Lomonosov Moscow State University, Faculty of Physics

² Lomonosov Moscow State University, International Laser Center

³ Institute of spectroscopy of the Russian Academy of Sciences

⁴ National Research University Higher School of Economics

e-mail: n.rovnyagina2015@yandex.ru

Fluorescent dye Thioflavin T (ThT) is a widely used probe for detection of amyloid fibrils, which are protein aggregates involved in the pathogenesis of neurodegenerative disorders. Upon the formation of a complex with amyloids, fluorescence quantum yield of ThT increases 1000-fold due to a dramatic reduction of the nonradiative decay rate. This is accompanied by a remarkable change of ThT fluorescence lifetime τ from \sim ps to \sim 1000 ps, thus making it possible to assess ThT binding to different systems using τ as an indicator. However, when measuring ThT interaction with proteins, one can observe that binding affinity determined from ThT fluorescence intensity dependence on protein concentration may be orders of magnitude lower than that determined using τ . Here we show that this discrepancy at least partly originates from a limited temporal resolution when determining fluorescence lifetime of ThT in the ThT-protein system using the time-correlated single photon counting technique (TCSPC), which is usually characterized by a \sim 100 ps instrument response function. This results in the situation when a small fraction (\sim 1%) of ThT molecules with a relatively slow decay ($\tau \sim$ 1000 ps) completely disguises the impact of ThT molecules with an ultrafast decay ($\tau \sim$ 1 ps) to the overall measured fluorescence decay curve. Moreover, using the femtosecond-resolved fluorescence up-conversion technique we demonstrate that not only free ThT molecules but also a subpopulation of protein-bound ThT molecules exhibits fluorescence decay on a 1 ps timescale. The obtained results are of critical importance for a reliable interpretation of protein binding and aggregation experiments when using a ThT assay with fluorescence lifetime determined by TCSPC as an indicator.

Ultrafast dynamics of electronic excitation in molecular rotors

E. A. Shirshin¹, G. S. Budylin², V. O. Kompanets³, N. R. Rovnyagina¹,
S. V. Chekalin³, V. I. Stepuro⁴

¹ M.V. Lomonosov Moscow State University, Moscow, Russia;

² Higher School of Economics, Faculty of Physics, Moscow, Russia;

³ Institute of Spectroscopy of the Russian Academy of Science, Troitsk, Russia;

⁴ Y. Kupala Grodno State University, Grodno, Belarus.

e-mail: shirshin@lid.phys.msu.ru

Thioflavin T (ThT) is the dye molecule widely used in a number of biomedical applications, including detection of amyloid fibrils, which are involved in pathogenesis of neurodegenerative diseases. ThT belongs to the class of molecules called molecular rotors, whose photophysical processes are governed by internal rotation of molecular fragments. Namely, ThT in aqueous solution exhibits low quantum yield due to rotation of its fragments upon excitation, which leads to formation of an intramolecular charge transfer (ITC) dark state. In contrast to this, being incorporated into rigid environment, ThT becomes “fixed“ and its fluorescence quantum yield increases dramatically. Underlying photophysical processes have been extensively studied by a number of ultrafast spectroscopy techniques, mainly by transient absorption spectroscopy. However, a number of important photophysical features, including the model excitation evolution on can be observed from time-resolved fluorescence emission spectra (TRES) on a subpicosecond timescale, that can be measured using the fluorescence up-conversion technique. In this work we report the results of investigation of ultrafast evolution of TRES of ThT and its structural derivatives in different solutions, which reveal structural determinants responsible for the rate of intramolecular rotation following excitation and concurrent photophysical processes.

Understanding of charge carrier dynamics in semiconductors: importance of concerted time-resolved techniques

A. Yartsev¹⁻³, W. Zhang^{1,4}, P.-A. Mante^{1,5}, X. Su^{1,2}, X. Zou^{1,2} and
M. Borström^{2,6}

¹ Division of Chemical Physics , Lund University;

² NanoLund, Lund University;

³ Institute of Photonics and Photon Technology, Northwest University, Xi'an;

⁴ School of Physics and Electronic Engineering, University of Guangzhou, Department of Applied Physics;

⁵ The Hong Kong Polytechnic University;

⁶ Division of Solid State Physics, Lund University.

e-mail: Arkady.Yartsev@chemphys.lu.se

Resolving charge carrier dynamics is essential for understanding the processes in various semiconductor materials. In particular, knowledge on charge carrier density and mobility are of special interest for most of opto-electric and electro-optic applications.

Conventionally, radiative recombination of charge carriers is of primary interest. Yet, non-radiative recombination could be an important factor that affects the carrier evolution and device performance, such as VOC limit in solar cells. Thus, thorough characterization of non-radiative carrier recombination channels is of significant fundamental and applied interest.

Processes at the semiconductor surface are believed to largely influence non-radiative recombination. This is especially relevant for nano-scale semiconductors with very large surface-to-volume ratio. Therefore, various attempts to reduce surface-related non-radiative recombination, namely, surface passivation, have been undertaken for improvement of various applications based on nano-scale semiconductor materials as well as for bulk semiconductors.

In our study, we aim at characterization of non-radiative recombination processes and at optimization of the surface passivation procedure. As the main research tool, we apply a combination of time-resolved and steady state spectroscopy techniques to characterize charge carrier dynamics in III-V semiconductor nanowires and bulk materials. The methods used build a complimentary and ample approach to understand dynamics of photogenerated charges in semiconductors. We have thoroughly characterized charge carrier dynamics in a large set of semiconductor III-V nanowires, in particular regarding the effect of semiconductor doping;[1] the content of the III-elements in InGaP;[2] in relation to the surface HCl etching[3] and in bulk GaAs.

For nearly all materials studied, we have concluded that non-radiative recombination is a dominant process. We associate mobile charge trapping, predominantly at the semiconductor surface, as the key process that quenches the material photoluminescence. At the same time, by means of time-resolved THz

spectroscopy we observe persistent photoconductivity signal long over the decay of photoluminescence. The non-radiative recombination of trapped and mobile charges was resolved by transient absorption technique.

Further studies are required to identify the nature of the trap states that is important for further optimization of semiconductor materials especially at nanometer characteristic scale. By means of time-resolved THz spectroscopy and picosecond acoustics, we have also established an approach to assess apparent and ultimate charge carrier mobility.[4,5]

REFERENCES

1. W. Zhang, S. Lehmann, K. Mergenthaler, J. Wallentin, M. Borgstrom, M.-E. Pistol, A. Yartsev. *Nano Letters*, 15 (11), 7238-7244 (2015).
2. W. Zhang, X. Zeng, X. Su, X. Zou, P.-A. Mante, M.T. Borgström, A. Yartsev. *Nano Letters*, 17 (7), 4248-4254 (2017).
3. X. Su, X. Zeng, H. Němec, X. Zou, W. Zhang, M.T. Borgström and A. Yartsev. *Nanoscale*, accepted, (2019).
4. C.S. Ponseca Jr, H. Němec, J. Wallentin, N. Anttu, J.P. Beech, A. Iqbal, M. Borgström, M.-E. Pistol, L. Samuelson, A. Yartsev. *Phys. Rev. B*, 90, 085405, 2014.
5. P.-A. Mante, C.C. Stoumpos, M.G. Kanatzidis, and A. Yartsev. *Nature, Communications*, 8, 14398, 2017.

The temperature dependence of ultrafast Stokes shift dynamics

I. P. Yermolenko¹, A. E. Nazarov¹, R. G. Fedunov¹ and A. I. Ivanov¹

¹Volgograd State University, Volgograd, Russian Federation
e-mail: yermolenkoigor@volsu.ru

The dynamics of ultrafast photochemical reactions initiated by a short laser pulse can strongly depend on the magnitude of the solvent relaxation time constants. Immediately after a photoexcitation of a solute it is in the Franck-Condon state with non-equilibrium both solvent and intramolecular vibrational environments. To control the ultrafast chemical dynamics, a knowledge of relaxation characteristics of the solvent and intramolecular modes is necessary with high accuracy. Typically, the solvent relaxation parameters can be determined from the Stokes shift dynamics or/and by modeling the dynamics of the first moments of the time resolved emission spectra. Within such an approach, it is difficult to separate the effect of intramolecular vibrational relaxation and solvent relaxation on spectral dynamics.

As in ref. [1] is shown, slowing down relaxation processes in the excited state of a Bethain-30 molecule, associated with the intramolecular rearrangement (internal rotation), as well as the change in the fluorescence spectra with temperature decreasing is associated with the effect of viscosity increasing. The problem of a division of the intramolecular vibrational and solvent relaxation impacts on the spectral dynamics can not be solved with temperature decreasing. However the time-resolved experiments with the variation of temperature can be helpful to clarify the timescale of the fastest mode which is independent of the viscosity.

In this report we present an analytical formula for modeling the temperature behaviour of the time-resolved emission spectra caused by variation of the relaxation characteristics of the solvent. We suppose that the characteristic time constants of the solvent are governed by the dynamic viscosity. The ultrafast Stokes shift dynamics for the solvents (ACN, DMSO, EG) with significantly different values of the viscosity activation energy (E_a) are analyzed.

The time-resolved emission spectra obtained for Coumarin 153 in polar solvents under normal conditions are chosen as the reference. The time constants of the solvents vary according to the Arrhenius law with respect to the reference values. The largest change in the Stokes shift value is typical for viscous solvents ($E_a \gg k_bT$), in which the weight of the fastest inertial mode is comparable to the weight of the other modes. It is well known that the fastest inertial mode is not controlled by the viscosity, as a result, changes in the Stokes shift caused by a variation in the temperature is predicted to be visible at the time scale exceeding 200 fs. Thus indicates that such measurement could provide valuable

information on temperature dependence of the solvent relaxation parameters and clarify their connection with macroscopic viscosity.

The study was performed by a grant from the RFBR (Grant No. 19-03-00175A)

REFERENCES

- [1] V. Kharlanov, W. Rettig, *J. Phys. Chem. A*, 40 (113), 10693 (2009).

Section 6: Physics and technology of ultrafast lasers and ultrashort laser pulses.

Section Chair:

Pavel Kostryukov, e-mail: pk@avesta.ru, kostryukov@gmail.com
(Avesta ltd., Russia)

Program committee:

Vladimir Chvykov
(Colorado State University, USA)

Martin Smrž
(HiLASE Centre, Czech Republic)

Scope

Solid-state, parametric, fiber, and hybrid laser systems

Stretchers, compressors, and phase control

Measurement and characterization of ultrashort pulses

Laser design and related issues

Innovative femtosecond technologies

Reconstruction of ultrashort optical pulse intensity and phase based on SPM spectra measurements in tellurite and germanate fibers

E. A. Anashkina¹, A. V. Andrianov¹, M. Y. Koptev¹, V. V. Dorofeev² and A. V. Kim¹

¹ Institute of Applied Physics of the Russian Academy of Sciences, Nizhny Novgorod, Russia;

² Devyatykh Institute of Chemistry of High-Purity Substances, Nizhny Novgorod, Russia
e-mail: elena.anashkina@gmail.com

Characterization of the intensity profile and phase of ultrashort optical pulses is a very important and challenging issue for numerous applications [1]. For obtaining temporal intensity and phase information, different techniques and approaches have been developed including widely used FROG (frequency-resolved optical gating). Numerous methods and their modifications existing today for reconstruction of ultrashort optical pulses have advantages and disadvantages, differ in the degree of complexity of their hardware and software implementation, have different areas of applicability and limitations [1].

Recently, a very simple method for measuring the intensity and phase of TW- and PW-class power pulses was proposed. It is based on measuring the fundamental (initial) pulse spectrum and two spectra transformed due to self-phase modulation in elements with Kerr nonlinearity (thin films) [2]. Based on this method, a technique for measuring ultrashort pulses with an energy ~ 1 nJ or higher using a piece of silica fiber as a nonlinear element was implemented [3]. Here we demonstrate and explore the possibility of implementing this method using a microstructured six-hole suspended core tellurite fiber and an all-solid germanate fiber as nonlinear elements for characterizing signals with a wide range of parameters. The nonlinear coefficients of these fibers are significantly higher than the nonlinear coefficient of silica fibers. This fact allows using them to measure pulses with very low energies and/or low peak powers. The intensity and phase of 80-fs pulses with an energy of ~ 100 pJ at 1.57 μm were retrieved experimentally using a tellurite fiber as well as the intensity and phase of 700-fs pulses at 1.55 μm were retrieved using a germanate fiber. These results were confirmed by independent FROG measurements. We believe that the reported optical metrology technique can be widely used in applications due to its robustness, low cost, and allowing operation with very low energies and/or peak powers.

The work is supported by the RFBR (18-52-45005 IND-a) and the Ministry of Education and Science (Contract 14.W03.31.0032).

REFERENCES

- [1] I.A. Walmsley, C. Dorrer, *Adv. Opt. Photonics* 1, 308 (2009).
- [2] E.A. Anashkina et al., *Sci. Rep.* 6, 33749 (2016).
- [3] E.A. Anashkina et al., *IEEE J. Sel. Top. Quantum Electron.* 24, 8700107 (2018).

Coherent combining of ultrashort pulses amplified in Yb-doped multi-core fiber amplifier

A. V. Andrianov¹, N. A. Kalinin^{1,2}, O. N. Egorova³, D. S. Lipatov⁴,
E. A. Anashkina¹, A. A. Balakin¹, S. A. Skobelev¹ and A. G. Litvak¹

¹ Institute of Applied Physics of the Russian Academy of Sciences, Nizhny Novgorod, Russia;

² Nizhny Novgorod State University, Nizhny Novgorod, Russia;

³ Fiber Optics Research Center, Russian Academy of Sciences, Moscow, Russia;

⁴ G.G. Devyatikh Institute of Chemistry of High-Purity Substances of the Russian Academy of Sciences, Nizhny Novgorod, Russia; e-mail: alex.v.andrianov@gmail.com

High peak power ultrashort pulse fiber amplifiers have attracted much attention in recent years. Scaling peak power to the MW range directly in a fiber amplifier is difficult due to nonlinear effects and ultimately limited by the onset of self-focusing. Coherent combining of many fiber amplifiers is promising for building high-power systems, however, in such systems a complicated feedback scheme is required to adjust the phases of the channels. Active multi-core fibers (MCFs), in which coherent amplification of several beams can be achieved under certain conditions, can be used in coherently combined system without any feedback. We have recently shown that in a MCF with even number of highly coupled cores arranged in a circle high power radiation can propagate as a supermode with equal intensities but interleaved zero/ π phases in the cores (“plus-minus“ mode), which is stable even in strongly nonlinear regime [1]. Total power of the “plus-minus“ mode can be many times higher than the self-focusing limit for a single-core fiber.

To test our theoretical conclusions, we developed a laser system based on a chirped pulse seed laser, home-made MCF with 6 strongly coupled and highly Yb-doped cores and a spatial light modulator for synthesizing the “plus-minus“ mode at the input of the MCF. We observed stable propagation and amplification of ultrashort pulses in the “plus-minus“ mode. Measured content of the “plus-minus“ mode was about 90% and did not change significantly with increasing pulse peak power. We studied coherent combining of the amplified signals into a single beam without any phase-adjusting feedback both experimentally and numerically. Optical systems that combine the output beams of MCF amplifier with efficiency of more than 80% and can be scaled to a large number of cores were proposed and numerically modeled. The possibilities of further scaling the total power exceeding the self-focusing limit in various configurations of MCF amplifiers and combining optics were studied in full-scale 3D numerical modeling.

This work is supported by Russian Science Foundation (grant No. 16-12-10472) and Ministry of Science and Higher Education of the Russian Federation (contract No. 14.W03.31.0032).

REFERENCES

[1] A. Balakin et al., Physical Review A, 98(4), 043857 (2018).

Mode locking of diode-pumped dye laser

O. A. Burdukova¹, M. V. Gorbunkov¹, V. A. Petukhov¹ and M. A. Semenov¹

¹Lebedev Physical Institute of the Russian Academy of Sciences, Moscow, Russia
e-mail: burdukova_olga@mail.ru

Pumping of dye lasers with semiconductor laser diodes can significantly simplify and reduce the cost of the entire system. To date, it has been shown that it is possible to obtain wide wavelength tuning range at a sufficiently high efficiency using laser diodes as a pump source. However, according to our knowledge, mode locking in dye lasers under diode pumping has not yet been performed.

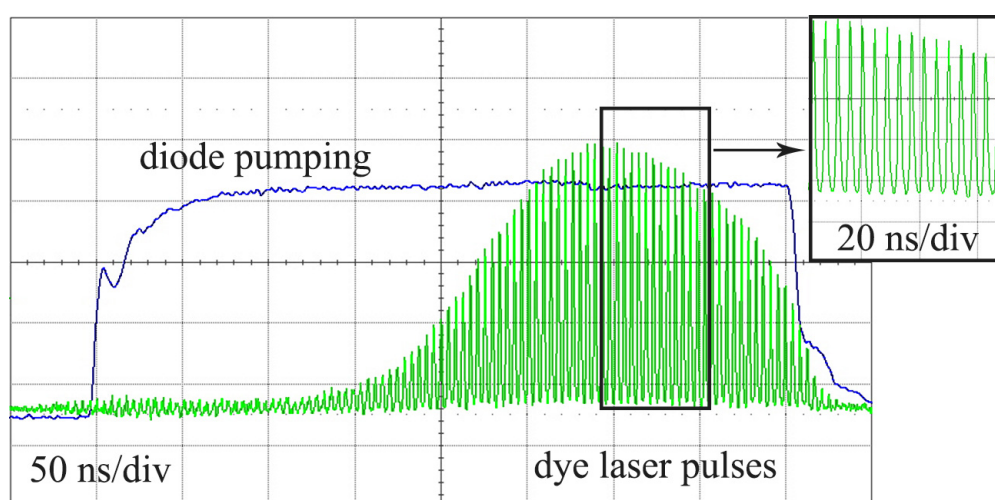

Figure 1: Temporal profiles of two diodes (without modulation) and dye laser pulses using mixture of Rhodamine 6G and DODCI in ethanol.

In this work, we report on the first successful experiment on the mode locking of diode-pumped dye laser. We used pulsed pumping of 400 ns duration by three green (513 nm) NDG7475 diodes of a cell with a mixture of dyes Rhodamine 6G and DODCI solved in ethanol. These dyes were used as an amplifying medium ($C_{R6G} = 2 \cdot 10^{-3} \text{ M/l}$) and a saturable absorber ($C_{DODCI} = 10^{-5} \text{ M/l}$), respectively. The thickness of the solution layer was 0.2 mm and the size of excited area $20 \times 40 \mu\text{m}$. The duration of the pump pulse was limited by the time of appearance of thermo-optical distortions in the dye cell. Preliminary experiments showed that due to the low gain (20 – 30 %) and the short pumping pulse, the mode locking does not have enough time to develop. However, diode pumping allows one to modulate the gain of the dye by changing the current through the diodes. We supplied one of the three diodes with current pulses of 1 ns duration and a repetition frequency of 253 MHz, corresponding to the round-trip time of the dye laser cavity. As a result, the laser began to generate ultrashort pulse trains with good repeatability. The fig. 1 shows pump and laser pulses taken by oscilloscope with a frequency band of 500 MHz. It can be argued

that the pulse width on the oscillogram is completely determined by the oscilloscope bandwidth, and the actual duration of the ultrashort pulses is much less than the width of the response function of the registration system ($\tau \approx 0.7$ ns). More accurate measurements of the laser pulse duration are planned using a streak-camera.

Thus, we first demonstrated the mode locking of dye laser pumped by semiconductor laser diodes.

This work was supported by the Russian Foundation for Basic Research (Grant No. 19-02-00344).

Towards KW average power of ultra-high peak power Ti:Sapphire laser systems.

V. Chvykov

Center for Extreme Ultraviolet Science and Technology, Colorado State University, Fort Collins, CO 80523, USA
e-mail: vladimir.chvykov@colostate.edu

The recent progress of the average power growing for the 100s TW- PW peak power laser systems will be discussed in this report. Two key problems should be resolved for further development, namely, the efficient pump lasers and a methods of effective heating extraction.

Compact bulk Yb:YAG active disk lasers pumped Ti:Sa. This approach relies on Ti:Sa as the gain medium and extending diode-pumped cryo-cooled Yb:YAG pump laser technology that has already been demonstrated at the kW average power level. This compact laser suitable for pumping a femtosecond laser is modular and therefore, scalable up to 80 kW average power level of $\lambda=515$ nm light and is able to pump up to 30 KW, 10 kHz, sub-30 fs Ti:Sa laser. The particular schema developed in Colorado State University will be presented and discussed [1].

Incoherent combined fiber pump lasers. Another approach to the problem of pump lasers is fiber-based laser system that uses commercial-off-the shelf, telecom-grade components in a fiber array that can spatially shape the gain profile and deliver Gaussian-like focal spots. The relative cost per joule of pump energy of the fiber-based pump system would be less than 25% that of conventional pump lasers [2].

Laser diodes pump. One of the most promising and efficient method of Ti:Sa laser pumping is direct using of the laser diodes in blue-green spectral range. In [3] first attempt of this system was presented. The efficiency of the energy extraction in this scheme was restricted to 2% due to CW pumping and a short lifetime of the upper laser level of the Ti:Sa crystal. Efficiency increasing requires a higher repetition rate (1-2 MHz) due to the necessity to have the time delay between two consequent pulses shorter than that of the upper state lifetime. The method of the achieving this repetition rate will be discussed too [4]. Recently, a significant progress of development of this type of pump lasers allowed to reach 0.5 kW in the very compact design which also appropriate to be scalable [5].

Efficient heating extraction. Thin disc (TD) lasers technology is a most popular now for the achieving of multi-kW regime due to effective heating extraction. Nevertheless, only recently the abilities of exploiting this method for Ti:Sa amplifiers were demonstrated [6] by using the combination of Extraction During Pumping method and TD (EDP-TD). The results of design, development and proof-of-principal experiments of EDPTD Ti:Sa amplifiers were presented [6,7].

It was shown that increasing the disk diameter whilst maintaining the same aspect ratio leads to extremely effective heat extraction and a flat temperature profile at a high repetition rate operation. Nevertheless, attempts to reduce the pulse energy and increase repetition rate while maintaining same average power have led to significant temperature rises due to reducing of the total volume of the gain media and so the ability of heating scattering. Solution of this problem exploiting the cross thin slab (XTS) geometry of the gain media [8,4] will be discussed in this talk. XTS-amplifiers can be used as a front -end as well as buster one in the high average power TW-PW laser systems. The design of the example and experimental results will be presented as well.

High output peak power requires a short pulse duration, and so large spectral bandwides. Several methods of the improvement of these parameters such as Polarization encoded Chirped Pulse Amplification (PE-CPA) [9,10] and an application of the external electrical field to the Ti:Sa crystals [11,12] will be considered also in this talk.

REFERENCES

- [1] Cory Baumgarten, et al, Optics Letters 41, 14, 3339 (2016)
- [2] Workshop on Laser Technology for k-BELLA and Beyond,
<http://www2.lbl.gov/LBL>
- [3] S. Backus et al, Optics Express, 25 (4). 3666 (2017).
- [4] Huabao Cao, Roland S Nagymihaly and Vladimir Chvykov, Laser Physics 29, 065802 (2019)
- [5] Britten S and Krause V, Ind. Laser Solut. 33 11 (2018)
- [6] V. Chvykov, et all, Optics Letters 41, 13, 3017 (2016).
- [7] R. S. Nagymihaly, et al Optics Express 25, 6, 6664 (2017).
- [8] V. Chvykov, H. Cao, R Nagymihaly JF2C.2, CLEO (2018)
- [9] M. Kalashnikov, H. Cao, K. Osvay and V. Chvykov, Optics Letters, 41 (2016) 25-28
- [10] H Cao, et al Laser Physics Letters 15 (4) (2018).
- [11] V. Chvykov, arXiv: 1803.10126 (2018).
- [12] V Chvykov, K Zemskov, N Ivanov, V Losev, Laser Physics Letters, 15, 125002 (2018)

Fiber laser switchable pulse generation with carbon nanotube saturable absorber with controlled nonlinear properties

Y. Gladush¹, A. Mkrtchyan¹, D. Kopylova¹, A. Ivanenko², B. Nyushkov², S. Kobtsev², A. Khagai³, M. Melkumov³, M. Burdanova⁴, M. Staniforth⁴, J. Lloyd-Hughes⁴ and A. G. Nasibulin^{1,5}

¹ Skolkovo Institute of Science and Technology, Nobel str. 3, 121205, Moscow, Russia

² Novosibirsk State University, Novosibirsk, 630090, Russia

³ Fiber Optic Research Center, Moscow, Russia

⁴ Department of Physics, University of Warwick, Coventry, CV4 7AL, UK

⁵ Aalto University, Espoo, 02150, Finland

e-mail: y.gladush@skoltech.ru

Carbon nanotubes saturable absorbers (SWCNT-SA) are well known alternative for conventional SESAMs for mode-locked fiber lasers. Also SWCNT-SA are easier in fabrication, cheaper and, in some configuration, they are more stable to thermal damage, however, until recently they did not provide any new capabilities compared to SESAMs. In present work we report a SWCNT-SA with controllable nonlinear optical response. We use electrochemical gating of the carbon nanotubes and demonstrate that it allows to gradually tune the SA modulation depth and provide a control over pulsed generation regime.

For the samples fabrication we synthesized high quality aerosol SWCNTs collected on the cellulose filter. SWCNTs were dry-transferred on the surface of side-polished fiber with subsequent electrochemical cell preparation. To control the nonlinear optical response of the cell we applied voltage on the cell electrodes up to 2 V. To investigate the nonlinear optical response, we used a pump-probe technique and retrieved the main parameters of the gated SWCNT-SA such as modulation depth and relaxation times as a function of allied voltage. We demonstrate that the modulation depth goes down under external voltage and even change the sign for high enough gating.

Finally, we implemented the SWCNT-SA in the fully PM erbium doped fiber laser and demonstrate that under applied voltage we managed to switch the laser generation between two pulsed regimes – sub-picosecond mode-locking and microsecond Q-switching. The regime switching is fully reproducible and can be performed on the fly in the working laser.

Paradoxical (up to 13) stimulated Raman scattering threshold reduction near the liquids nitrogen interface: new type of Raman lasing

S. M. Pershin¹, M. Ya. Grishin^{1,2}, V. N. Lednev¹, P. A. Chizhov¹ and I. A. Khodasevich³

¹ Prokhorov General Physics Institute of Russian Academy of Sciences, Moscow, Russia;

² Moscow Institute of Physics and Technology (State University), Dolgoprudny, Moscow Region, Russia;

³ Stepanov Institute of Physics of the National Academy of Sciences of Belarus, Minsk, Republic of Belarus.

e-mail: mikhail.grishin@kapella.gpi.ru

We report on anomalous (up to 13-fold) stimulated Raman scattering (SRS) threshold reduction while probing liquid nitrogen by 15-ps laser pulses focused near the liquid/air interface. An N-shaped dependence of the SRS threshold on lens-to-surface distance has been revealed, with threshold energy reaching its minimum when beam waist coincides with liquid/air interface. To explain SRS threshold dependence we suggested a new mechanism of Raman lasing near liquid-to-air interface.

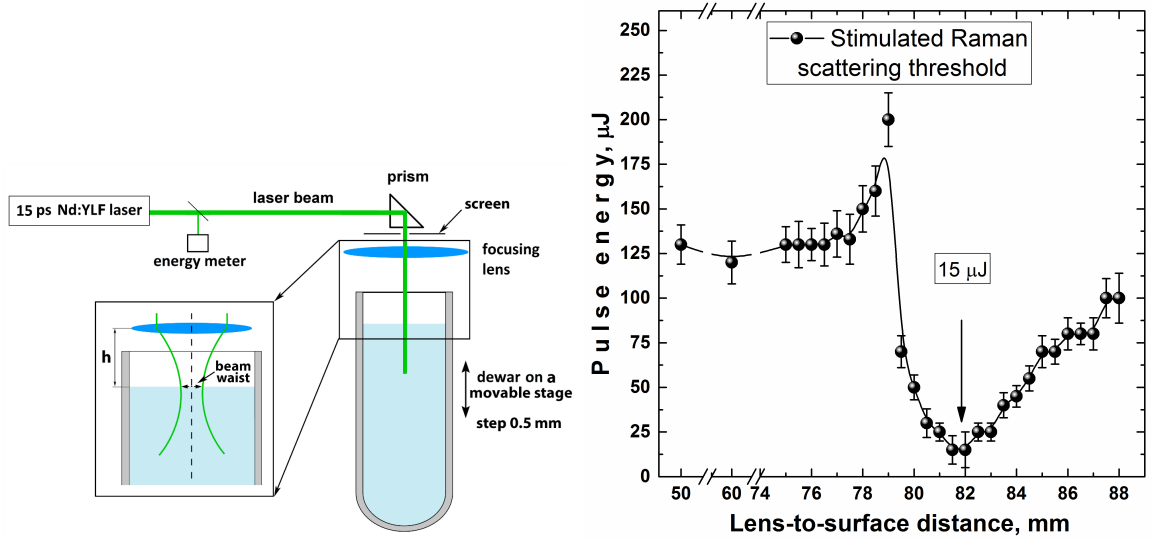

Figure 1: (left) Experimental setup for stimulated Raman scattering threshold measurements (Nd:YLF laser: $\lambda = 527$ nm, $M2 = 1.5$, $\tau = 15$ ps, $E \leq 5$ mJ, 5 Hz). (right) Stimulated Raman scattering threshold dependence as a function of laser beam waist position relative to air-to-liquid interface.

Authors acknowledge Russian foundation for basic research for financial support of the study (RFBR 18-52-00038 Bel-a).

Toward the next generation of high-peak-power lasers

E. Khazanov

Institute of Applied Physics of the Russian Academy of Sciences, Nizhny Novgorod, Russia;

e-mail: efimkhazanov@gmail.com

The peak power of present-day lasers is limited by the pulse energy which the diffraction gratings of an optical compressor can withstand. We discuss a promising method of overcoming this barrier: the pulse power is shortened due to shortening its duration rather than due to the enhancement of its energy. It is important that the pulse is shortened after compressor - the Compression after Compressor Approach (CafCA). To do so, the pulse spectrum is stretched as a result of self-phase modulation and then the pulse is compressed by dispersion mirrors. This idea has been known since the 1960s but its application to lasers with a power beyond 1 TW was restricted until recently by a number of physical problems. These problems and possible ways of their solution will be discussed in detail. The experimental results obtained over the past few years demonstrate the efficiency of the technique (compression by a factor of 5) in the range up to 250 TW. CafCA possesses three undisputed merits: simplicity and low cost, negligible pulse energy loss, and applicability to any high-power laser.

Observation of the bound-state generation in a SESAM mode-locked Cr:ZnSe laser

S. O. Leonov^{1,2}, M. P. Frolov¹, Yu. V. Korostelin¹, Y. K. Skasyrsky¹ and V. I. Kozlovsky¹

¹ P. N. Lebedev Physical Institute of the Russian Academy of Sciences, Moscow, Russia;

² Bauman Moscow State Technical University, Moscow, Russia

e-mail: leonov.sto@gmail.com

During the last years one can observe an increasing trend in developing of solid-state mid-infrared (mid-IR) laser. Chromium (Cr^{2+}) - doped zinc selenide (ZnSe) is a typical representative of the II-VI family with a wavelength tuning range between 2 and 3.2 μm and a possibility of femtosecond operation usually referred to as the “Ti:sapphire of the mid-IR” [1]. One of the interesting operation regimes of the passively mode-locked lasers is harmonic operation. To date, a lot of research on harmonic operation was done for the mode-locked fi

ber lasers [2, 3]. However, harmonic operation is not only appeared in mode-locked

fiber lasers it has also been observed in mode-locked solid-state lasers [4]. It was demonstrated a double-pulsed [5] and a multiple pulsed operation in the chirped-pulse regime [6] for the $\text{Cr}^{2+}:\text{ZnSe}$ mode-locked lasers.

In this work, we present an experimental observation of the the bound-state generation in a SESAM mode-locked $\text{Cr}^{2+}:\text{ZnSe}$ laser operating around 2475 nm with the pulse to pulse time separation of 19.7 ps and the phase difference of π .

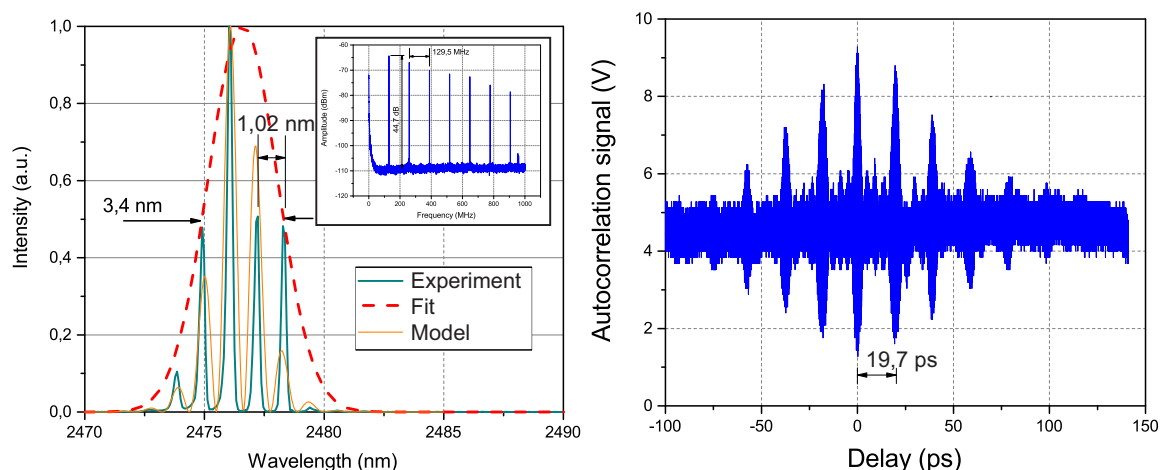

Figure 1: a) Optical spectrum and the radiofrequency spectrum (inset) for the bound-state generation regime. b) Autocorrelation trace for the bound-state generation regime.

Figure 1 shows the optical spectrum with the regular spectral modulation period of 1.02 nm what corresponds to pulses time separation of 19.5 ps. Also

the pulse to pulse time separation was measured with home-made collinear autocorrelator and is equal to 19.7 ps being in a good agreement with predicted one.

REFERENCES

- [1] I. Sorokina, E. Sorokin, *IEEE Journal of selected topics in Quantum Electronics* 21(1), 273-291 (2014).
- [2] L. Gui, P. Wang, Y. Ding, K. Zhao, C. Bao, X. Xiao, and C. Yang, *Applied Sciences* 8 (2018).
- [3] C. Zeng, Y. Cui, and J. Guo, *Optics Communications* 347, 4449 (2015).
- [4] J.-H. Lin, W.-F. Hsieh, and H.-H. Wu, *Optics Communications* 212, 149 158 (2002).
- [5] N. Tolstik, E. Sorokin, and I. T. Sorokina, *Opt. Lett.* 38, 299301 (2013).
- [6] X. Bu, Y. Shi, J. Xu, H. Li, and P. Wang, *Applied Physics B* 124, 99 (2018).

Progress on the THL-100 hybrid laser system in visible

V. F. Losev, N. G. Ivanov, S. V. Alekseev, Yu. N. Panchenko,
A. G. Yastremsky

Institute of High-Current Electronics SB RAS, Akademichesky Avenue 2/3, 634055, Tomsk
e-mail: losev@ogl.hcei.tsc.ru

Experimental results of formation, amplification and compression in a laser system of a second-harmonic radiation pulse with a central wavelength of 475 nm and a spectral width of 8 nm are presented. The spectrum of second harmonic was broadened in the process of converting a chirped fundamental frequency radiation pulse into KDP. Amplification of radiation in XeF(C-A) amplifier was carried out after the prism stretcher extending the pulse to 1.8 ps. At the output of XeF(C-A) amplifier the energy of 1.2 J was obtained. As a result of compression of amplified radiation pulse in a fused silica block its duration was 29.4 fs. This corresponds to the radiation pulse power of 40 TW at the output of laser system.

The work was supported by the Russian Foundation for Basic Research in the framework of research projects N 18-08-00383-a and N 18-08-00407-a

Development of a short pulse broadband and narrowlinewidth ultraviolet laser using Ce:LiCAF crystal, orienting to lidar applications

Pham Hong Minh¹, Pham Van Duong¹, Nguyen Xuan Tu¹, Nguyen Van Diep¹,
N. Sarukura², M. Cadatal-Raduban³

¹ Institute of Physics, Vietnam Academy of Science and Technology, 10 Dao Tan, Ba Dinh, Hanoi, Vietnam

² Institute of Laser Engineering, Osaka University, Suita Osaka 565-0871 Japan

³ Centre for Theoretical Chemistry and Physics, School of Natural and Computational Sciences, Massey University, Albany, Auckland 0632, New Zealand

e-mail: phminh@iop.vast.ac.vn

We report the successful development of an all-solid state laser based on a Czochralski method-grown cerium-doped lithium calcium aluminum fluoride ($Ce^{3+} : LiCaAlF_6$) crystal as the gain medium. Results for the broadband, narrow linewidth and short pulse laser emission are obtained by using 7 ns pulses at 266 nm from the fourth harmonics of a Nd:YAG laser operating at 10 Hz as pump. The effects of output coupler reflectivity, resonator length and pump energy on the laser pulse duration were explored. With broadband configuration, a maximum output pulse energy of few mJ were achieved. A sub-nanosecond UV laser pulses were generated from a low-Q and short resonator under a near threshold pump energy. By replacing the end mirror with a grating, tunability from 281 nm to 299 nm with linewidth of about 0.2 nm is achieved.

Pseudo-active mirror disk amplifiers in Nd:YAG delivering 50J 10Hz for high-rep rate PW-class laser pumping

F. Mollica¹ and S. Branly¹

¹ Amplitude Laser Group, 91090 Lisses, France
e-mail: florian.mollica@amplitude-laser.com

Development of new high-repetition rate ($>1\text{Hz}$) ultrafast ultra-intense ($>1\text{PW}$) sources has been slow down by the difficulties to achieve sufficient average power and pulse energy with nanosecond pump lasers [1] Promising development of High energy OPCPA system [2] for instance require synchronized single pump beam, meaning it is not possible to stack standard off-the-shelf nanosecond pump lasers in order to reach energy well above 10J. High Energy and High repetition rate cryo-cooled, diode-pumped lasers have been developed at prohibiting costs [3]. We present here a new laser named Premiumlite delivering 75J at 1064nm and 50J at 532nm at a rep-rate of 10Hz. Thanks to an innovative amplifier technology named “Pseudo-Active Mirror Disk Amplifier Module“, this laser overcomes by a factor 5 average power and energy of state-of-the-art Nd:Yag lasers, while delivering comparable energy as Nd:glass sytem at rep rate 100 times faster. Disk Amplifier Modules are flashlamp-pumped in order to offer a cost-effective, compact solution, at a fraction of the cost of diode-pumped designs.

This laser have been developed in the framework of the ELI-ALPS Project in Hungary [4], and 2 PremiumLite have been commissioned as pump laser for the last Ti:Sa Amplifier. The ELI-ALPS Laser will reach 2 PW at 10Hz with pulses of 17fs. The PremiumLite Factory Acceptance Test included 2 months of operation with 9h per day in presence of the ELI customers. We measured a pulse-to-pulse energy stability of 0.5% RMS at 1064nm and 1% RMS at 532nm and no energy drift on long term.. The laser delivers a uniform top-hat beam profile with round or square shape. The nominal gaussian pulse duration is 5-7 ns. Low B-integral design makes temporally shaped pulses from 1.5 to 100ns compatible with the laser architecture.

This new amplification technology will pave the way towards high rep rate multi-PW system. Its versatility enables to explore other innovative systems. Same design with Nd:glass gain medium is in development, with 200J at 0.1Hz expected, synchronized with a particle accelerator at ESRF Grenoble, France. We could as well replace flashlamps pumping by diode pumping, increasing power by a factor 5. These examples show how this technology increases scientific throughput of ultra-intense laser sciences and brings them closer to their applications.

REFERENCES

[1] Danson, C., Hillier, D., Hopps, N., & Neely, D. (2015). Petawatt class lasers

worldwide. High Power Laser Science and Engineering

[2] H. Kiriya et al., “High-contrast high-intensity repetitive petawatt laser,” *Opt. Lett.* 43, 2595-2598 (2018)

[3] S. Banerjee et al., “100 J-level nanosecond pulsed diode pumped solid state laser,” *Opt. Lett.* 41, 2089-2092 (2016)

[4] Sergei Kühn et al 2017 *J. Phys. B: At. Mol. Opt. Phys.* 50 132002

Picosecond Raman laser near air-water interface: paradoxical (8-fold) threshold reduction

S. M. Pershin¹, M. Ya. Grishin^{1,2}, P. A. Chizhov¹, I. A. Khodasevich³,
V. N. Lednev¹, V. A. Orlovich³ and A. I. Vodchits³

¹ Prokhorov General Physics Institute of Russian Academy of Sciences, Moscow, Russia;

² Moscow Institute of Physics and Technology (State University), Dolgoprudny, Moscow Region, Russia;

³ Stepanov Institute of Physics of the National Academy of Sciences of Belarus, Minsk, Republic of Belarus.

e-mail: pershin@kapella.gpi.ru

For the first time, we have demonstrated a 8-fold decrease of stimulated Raman scattering threshold at liquid-to-air interface compared to that for bulk liquid. Abnormal stimulated Raman scattering threshold dependence as function of lens-to-surface distance was observed when laser beam waist transferred through liquid-air surface. Minimum stimulated Raman scattering threshold was achieved when pumping laser beam waist was located at the liquid surface. A new mechanism of Raman lasing was suggested to explain the observed results.

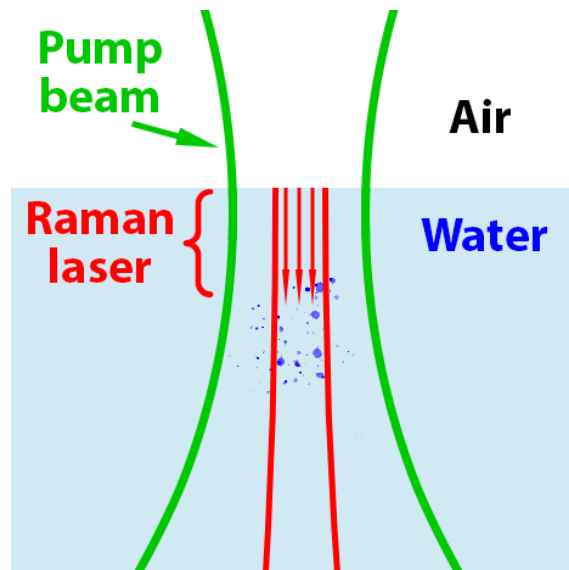

Figure 1: Scheme of a new Raman laser near air-to-liquid interface

Authors acknowledge Russian foundation for basic research for financial support of the study (RFBR 18-52-00038 Bel-a).

Stimulated Raman scattering spectrum narrowing under picosecond pulse train pumping

S. M. Pershin¹, A. S. Komelkov¹, E. V. Shashkov¹, N. S. Vorobyev¹,
M. Y. Grishin^{1,2}, M. A. Davydov¹ and A. N. Fedorov¹

¹ Prokhorov General Physics Institute of Russian Academy of Sciences, Moscow, Russia;

² Moscow Institute of Physics and Technology (State University), Dolgoprudny, Moscow Region, Russia

e-mail: pershin@kapella.gpi.ru

For the first time we have observed a narrowing of the stimulated Raman scattering (SRS) spectrum under picosecond pulse train excitation (four 80-ps pulses separated by 8 ns intervals). OH stretching vibration band of SRS spectrum in water decreased to 100 cm^{-1} (Fig.1, solid line) compared to $350\text{--}400\text{ cm}^{-1}$ for spontaneous Raman scattering of a single 15-ps pulse (Fig.1, dashed line) [1].

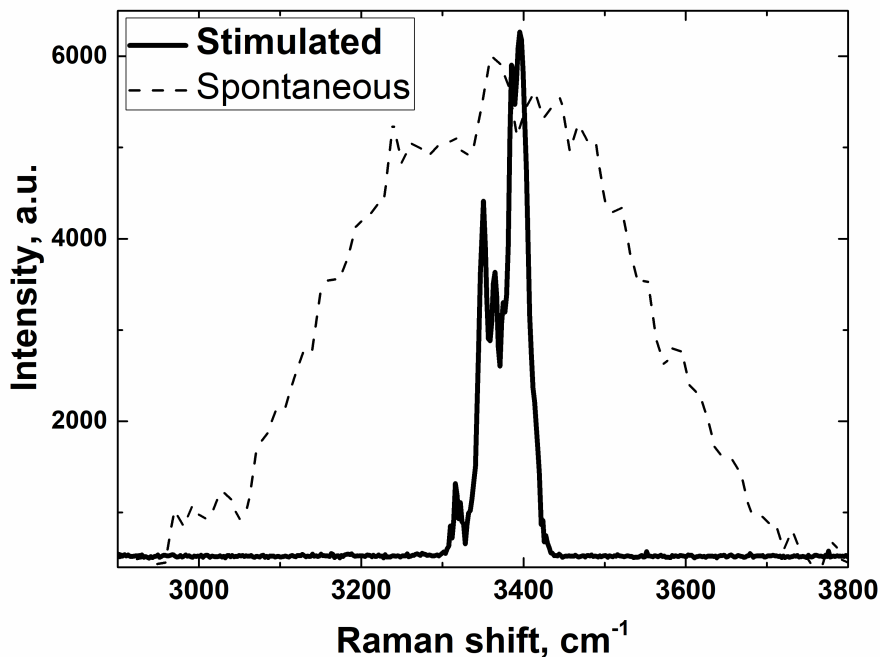

Figure 1: Stimulated Raman scattering OH band spectrum for picosecond pulse train pumping (solid line) near the air-water interface and spontaneous Raman scattering spectrum in a bulk water pumped by 15-ps pulse (dashed line).

Previously, M.A. Bolshov et al. [2] utilized a train of 25 3-ps pulses separated by 10 ns intervals and obtained OH band Raman spectrum width of $350\text{--}400\text{ cm}^{-1}$ [2]. Recently, V.A. Babenko et al. [3] demonstrated that SRS OH band for single 20-ps pulse excitation was 4-fold narrower ($\sim 100\text{ cm}^{-1}$) compared to that for long train of picosecond pulses. The nature of such stimulated Raman scattering spectrum transformations versus pulse train duration is discussed.

Authors acknowledge Russian foundation for basic research for financial support of the study (RFBR 18-52-00038 Bel-a).

REFERENCES

- [1] S.M. Pershin, M.Ya. Grishin, V.N. Lednev, S.V. Garnov, V.V. Bukin, P.A. Chizhov, I.A. Khodasevich, V.B. Oshurko, *Laser Phys. Lett.* 15, p. 035701 (2018).
- [2] M.A. Bol'shov, Y.I. Golyaev, V.S. Dneprovskii and I.I. Nurminskii, *Soviet Physics JETP*, 30 190 (1970).
- [3] V.A. Babenko, N.F. Bunkin, A.A. Sychev, *Russian JETP*, 155(5), 782 (2019).

Inline spectral interferometry in short-wave and mid-wave infrared laser filaments in gases for carrier-envelope-phase characterization

P. Polynkin

¹ University of Arizona, USA
e-mail: ppolynkin@optics.arizona.edu

I will discuss experiments and numerical simulations on the nonlinear propagation of intense, ultrashort laser pulses at the wavelengths of 1.7 μm and 3.9 μm in air and argon. For both lasers, we observed carrier-envelope-phase (CEP) dependent interference in the visible part of the broadband spectra generated on propagation. In the case of the CEP-stable 1.7 μm driver, the interference effect is robust against large fluctuations of the input pulse energy of the laser. The reason for this robustness is the rigid clamping of both the peak optical field and the phase of the propagating waveform that has been revealed by numerical simulations. We attempted to use the spectral interference effect to characterize CEP in a CEP-unstable, ultrafast, mid-infrared laser source at 3.9 μm .

Tunable from 3.8 to 5.1 μm continuous-wave Fe:ZnSe laser for spectroscopic application

A. V. Pushkin¹, E. I. Mareev¹ and F. V. Potemkin¹

¹ Faculty of Physics and International Laser Center M.V. Lomonosov Moscow State University
e-mail: av.pushkin@physics.msu.ru

Mid-IR lasers are of increased interest for many applications, such as molecular spectroscopy, free space communication, nonlinear optics, etc. [1], [2]. The 2-5- μm range is often called the molecular fingerprint region due to the presence of strong fundamental absorption lines for various gases and atmosphere components, which makes such laser sources useful for remote sensing and environmental control.

The competitive properties of a laser source for its use in spectroscopic studies are a narrow spectral band, a wide tuning and an acceptable output power. The remarkable laser properties of the Fe:ZnSe active medium, such as high absorption and emission cross sections and a broad gain band [3], make it possible to develop a CW broadly tunable laser source in the wavelength range of approximately 3800-5100 nm and output power of several hundred milliwatts.

The high output power level is achievable due to the availability of high-power fiber CW Er: ZBLAN pump sources (2.8 μm) [4]. To date, the output power of such lasers reached several dozens of Watts, which makes them attractive for pump other laser media with absorption in 3- μm region (for example, Fe: CdSe [5]).

The developed 4- μm laser is a useful tool for supercritical CO₂ spectroscopy, possessing absorption lines at about 4.3 μm ([6]). Laser spectroscopy is able to characterize the structure of the formed molecular clusters in a wide range of pressures. Supercritical CO₂ due to interesting chemical properties is used as a buffer medium in the formation of nanostructures.

In this work, we present a powerful broadly tunable mid-IR Fe:ZnSe laser and demonstrate its spectroscopy application.

REFERENCES

- [1] Mirov S. et al., IEEE J Sel Top Quantum Electron., 24(5), 1-29. (2018)
- [2] Sorokin E. et al., IEEE J Sel Top Quantum Electron.11(3):690-712. (2005)
- [3] Fedorov V.V. et al., IEEE J Quantum Electron., 42(9):907-17. (2006)
- [4] Pushkin A.V. et al., 15;43(24): 5941 (2018)
- [5] Frolov M.P. et al., Laser Phys Lett ;14(2) (2017)
- [6] J. Norooz Olliaee et al., J. Chem. Phys., 135(4), p. 044315, (2011).

Active optical systems for high speed imaging

M. V. Trigub

V.E. Zuev Institute of Atmospheric Optics SB RAS, Tomsk, Russia;
e-mail: trigub@iao.ru

The use of laser active media allow to solve problems of high speed imaging of processes. High speed imaging is one of the most popular method for studying the processes in the region of interaction of intense energy fluxes with matter. One of the problem of such processes visual diagnostics is the glare which is the result of the interaction. The method based on the image active filtration by metal vapor brightness amplifiers makes it possible to image such processes. Active optical systems with metal vapor brightness amplifiers (which is called Laser monitor), have shown the high efficiency for reducing the background radiation effect on the observing processes in the real-time mode [1]. The typical diagrams of laser monitors are shown on the fig.1

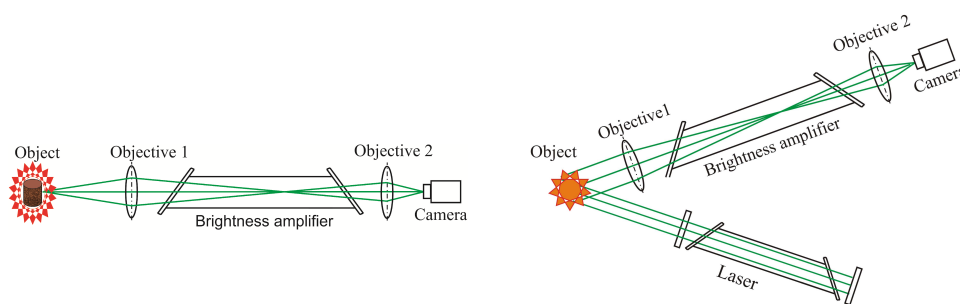

Figure 1: The laser monitor diagrams: a – monostatic, b – bistatic configuration.

The parameters of a brightness amplifier determine the active optical systems features. The result of the development of the high speed brightness amplifiers (functional converters of optical signals) are presented. The ability to use these amplifiers for high-speed imaging is discussed. The examples of the imaging of laser pulse interaction with a matter by the laser monitor based on the brightness amplifiers are shown.

The work was supported by the Russian Science Foundation, Project No 19-79-10096.

REFERENCES

- [1] Trigub, M. V., Platonov, V. V., Evtushenko, G. S., Osipov, V. V., & Evtushenko, T. G. Laser monitors for high speed imaging of materials modification and production. *Vacuum*, 143, 486-490 (2017).

Information theory approach to acousto-optic high-definition laser pulse shaping

K. B. Yushkov¹ and V. Ya. Molchanov¹

¹National University of Science and Technology MISIS, Moscow, Russia
e-mail: konstantin.yushkov@misis.ru

Arbitrary shaping of ultrashort laser pulses is required in many application fields from inertial confinement fusion to telecommunications. Acousto-optic (AO) dispersive delay lines can be effectively used for this purpose [1-4]. An arbitrary transmission function of an AO device can be synthesized to shape the complex-valued spectrum of diffracted light. Advanced pulse shaping methods, including multichannel arbitrary modulation [2-3] and phase-only pulse replication [4], are enabled by specially synthesized RF signals with complex-valued spectra. In this report, we analyze the nuances of digital RF signal synthesis for AO delay lines.

The dispersive method of transmission function synthesis is based of relations between the duration of the chirped RF waveform, its bandwidth, and the second order dispersion (SOD). Total optical dispersion of the device is a sum of diffraction-induced dispersion and passive dispersion of the AO crystal. Fourier transform of a rectangular spectral function with the bandwidth Δf and the SOD Ψ_2 is a complex valued function with the the main maximum width $T_0 = 4\pi\Psi_2\Delta f$ [2]. The bandwidth Δf is chosen to match the spectrum of ultrashort pulses. The maximum duration of the RF waveform is limited by the acoustic time aperture of the AO dispersive delay line that is typically between 10 and 100 μs depending on configuration and material of the AO device.

According to Kotelnikov's theorem [5], the sampling interval in time domain is $\delta t_s = 1/(2\Delta f)$, hence the total number of points in the RF waveform is $N_s = T_0/\delta t_s = 2\Delta f T_0$. On the other hand, the RF waveform is calculated using the discrete Fourier transform (DFT) and the generated discrete signal is periodic with $T_{\text{per}} = N_s/\Delta f = 2T_0$. A common approach is to truncate the RF waveform and to keep only its central part having the duration T_0 filling the full time aperture of the delay line. Thus, maximum efficiency of ultrashort pulse diffraction can be achieved. We demonstrate that this approach results in distortions in the diffracted emission spectrum originating from partial loss of the details in the RF waveform. That causes degradation of modulation contrast and resolution. For high-definition pulse shaping, we propose an alternative method choosing T_0 not exceeding a half of the time aperture. Thus, the full RF waveform can be reproduced by the AO delay line instantaneously, and accuracy of spectral shaping increases.

The research was supported by the Russian Foundation for Basic Research (Project 18-29-20019).

REFERENCES

- [1] V.Ya. Molchanov et al., *Appl. Opt.*, 48 (7), C118 (2009).
- [2] V.Ya. Molchanov, K.B. Yushkov, *Opt. Express*, 22 (13), 15668 (2014).
- [3] K.B. Yushkov et al., *Opt. Lett.*, 41 (23), 5442 (2016).
- [4] K.B. Yushkov et al., *Phys. Rev. A*, 96 (4), 043866 (2017).
- [5] V.A. Kotelnikov, *Phys. Usp.*, 49 (4), 736 (2006).

Section 7: Femtosecond radiation in spectroscopy and optical frequency metrology

Section Chair:

Elena Fedorova, e-mail: kalganova.elena@gmail.com
(Lebedev Physical Institute, Russia)

Program committee:

Mikhail Gubin
(Lebedev Physical Institute, Russia)

Alexey Taichenachev
(Institute of Laser Physics, Russia)

Scope

Absolute optical frequency measurements

Femtosecond frequency combs for direct spectroscopy of ions and atoms

UV and HUV frequency combs

Frequency combs in astrophysics

Optical frequency combs applications

Pulsed femtosecond optical dipole trap for neutral atoms

A. E. Afanasiev¹, A. A. Meysterson^{1,2}, A. M. Mashko^{1,3}, P. N. Melentiev¹,
V. I. Balykin¹

¹ Institute of Spectroscopy Russian Academy of Sciences, Troitsk, Russia;

² Moscow Institute of Physics and Technology, Moscow Region, Russia;

³ National Research University Higher School of Economics, Moscow, Russia;

e-mail: afanasiev@isan.troitsk.ru

Laser cooling and trapping of neutral atoms and ions have led to recent advances in quantum information and quantum sensorics. Applied techniques is limited by the continuous wave lasers now. This limits the class of atoms for laser cooling, trapping and manipulation with such that have convenient internal structure for common lasers. A lack of ultraviolet narrow-band lasers precludes laser cooling and trapping such atoms as hydrogen, antihydrogen, carbon, oxygen and nitrogen.

From the other side, the pulsed lasers can produce high power laser radiation of ultraviolet frequency range. This can be used to broader the number of cooled and trapped atoms. Such approach may provide a route to ultracold ensembles of atoms used in organic chemistry (hydrogen, carbon, oxygen, nitrogen), fundamental research (antihydrogen) and also to more technologically interesting atoms (chromium, indium, silver and aluminium) which have resonance transitions in the blue and uv part of the spectrum [1]. Recently it was shown the experimental approaches for laser cooling with ultrashort pulsed laser radiation [2,3]. There are several experiments on dipole trapping of cold atoms with using of picoseconds pulsed laser radiation [4,5].

In our work for the first time we have demonstrated atom dipole trap using femtosecond laser radiation with pulse duration up to 70 fs. The implementation of the atom femto trap was possible only at small initial atoms temperature and at low average laser intensities when the momentum diffusion due to dipole force fluctuations is small. Our experimental data agree with the theoretical calculations. It should be noted that in case of using of femtosecond pulsed laser radiation for dipole trapping of atoms the time interval during which the atom interacts with laser field is only 10^{-7} - 10^{-8} of the total localization time interval. This is open up a new approaches of controlling of atoms motion without strong laser light affection on the internal degrees of freedom [5,6].

The reported study was funded by RFBR according to the research project N18-02-00429.

REFERENCES

- [1] D. Kielpinski, Phys.Rev. A, 73, 063407 (2006); A. M. Jayich, X. Long, and W. C. Campbel, Physical Review X, 6, 041004 (2016).
- [2] N. Santic, et. al, Scientific reports, 9, 2510 (2019).

- [3] R.B.M. Clarke, T. Graf, E. Riis, *Appl. Phys. B*, 70, 695 (2000).
- [4] M. Shiddiq, E. M. Ahmed, M. D. Havey, and C. I. Sukenik, *Phys.Rev. A*, 77, 045401 (2008).
- [5] V. I. Balykin, *JETP Letters*, Vol. 81, 209, (2005).
- [6] D.N. Yanyshch, V.I. Balykin, Y.V. Vladimirova, and V.N. Zadkov, *Phys.Rev. A*, 87, 033411 (2013).

Noise reduction in a multi-Stokes Brillouin laser

I. V. Balakireva^{1,2}, A. Sebastian², S. Fresnel², S. Trebaol², and P. Besnard²

¹ Russian Metrological Institute of Technical Physics and Radio Engineering, 141570 Mendeleevo, Solnechnogorsk district, Moscow region, Russia

² Univ Rennes, CNRS, Institut FOTON – UMR 6082, F-22305 Lannion, France
e-mail: balakireva@vniiftri.ru

The ultra-low noise optical and RF sources are required in different fields of physics, such as metrology, atomic clock, communications, etc. One of the process, which can be used to induce low noise lasers is Stimulated Brillouin Scattering (SBS) [1,2]. Cascading the SBS process by using one Stokes wave, as a pump, for the next red shifted Stokes brings the possibility to produce a comb source [3]. Our study concerns the potential of such cascading to improve the noise characteristic. We analyze the noise of each Stokes wave of the cascaded SBS process. We observe experimentally up to 20 dB/Hz intensity noise reduction compared to that of the RIN input pump laser (Fig. 1) and predict theoretically up to 40 dB/Hz reduction [4]. We examine the impact of the Brillouin gain and laser detunings on the noise properties. A numerical model based on a set of coupled-mode equations [4,5] replicates the experimental observations. Our study enables us to determine the optimal parameters to operate the multi-Stokes laser in the low noise regime, which can be used to create the low-noise optical [6] and RF sources [7].

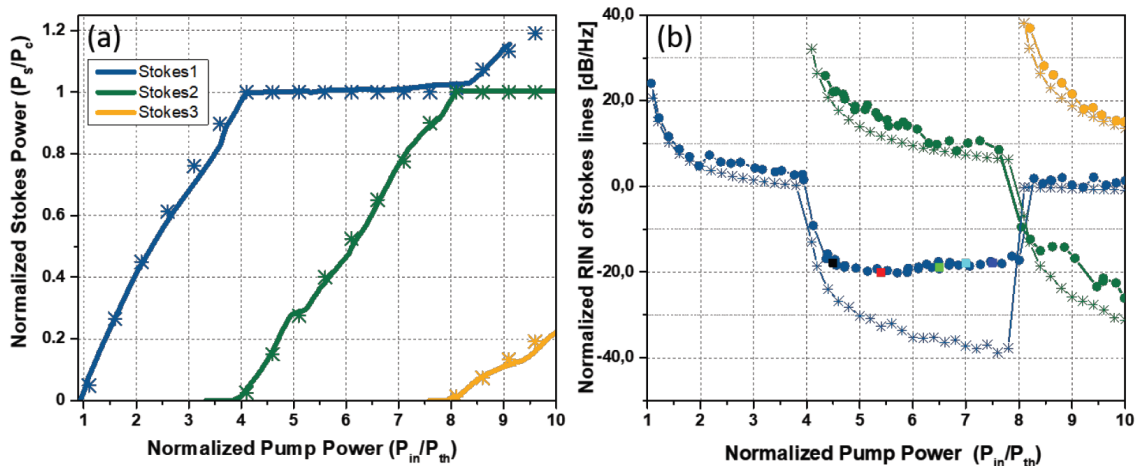

Figure 1: (a) Output Stokes power (P_s) normalized to the circulating power (P_c) versus input pump power (P_{in}) normalized to the Stokes 1 lasing threshold (P_{th}). (b) RIN of Stokes lines normalized to the input pump RIN (at 4 kHz from the carrier). Lines with full dots are experimental, and stars are simulation results. Square symbols correspond to numerical simulations including gain detuning.

REFERENCES

- [1] E. Ippen, R. Stolen, Appl. Phys. Lett. 21, 539-541 (1972).
- [2] S. Smith, F. Zarinetchi, and S. Ezekiel, Opt. Lett. 16, 393-395 (1991).
- [3] D. Lim, H. Lee, K. Kim, S. Kang, J. Ahn, and M.-Y. Jeon, Opt. Lett. 23,

1671-1673 (1998).

[4] A. Sebastian, I. V. Balakireva, S. Fresnel, S. Trebaol, and P. Besnard, *Opt. Exp.* 26 (26), 33700 (2018).

[5] W. Loh, S. B. Papp, and S. A. Diddams, *Phys. Rev. A* 91, 053843 (2015).

[6] A. Choudhary, M. Pelusi, D. Marpaung, T. Inoue, K. Vu, P. Ma, D.-Y. Choi, S. Madden, S. Namiki, and B. J. Eggleton, *Opt. Lett.* 42, 5074-5077 (2017).

[7] J. Li, H. Lee, and K. J. Vahala, *Nat. Comm.* 4, 2097 (2013).

Experimental results of a fs laser application for phase calibration of the frequency ranges of a VLBI radio-telescope receiving systems

A. V. Vytnov¹, D. V. Ivanov¹, I. A. Rahimov¹, E. Yu. Khvostov¹,
 A. A. Tsaruk¹, A. S. Karpichev¹, V. O. Ken¹, A. N. Kireev², D. A. Tyurikov²,
 A. S. Shelkovnikov², A. V. Tausenev², N. N. Kolachevskiy², M.A. Gubin^{2,3}

¹ Institute of Applied astronomy, Russian Academy of Sciences, S.-Petersburg, Russia

² P.N. Lebedev Physical Institute, Russian Academy of Sciences, Moscow, Russia

³ FSUE VNIIFTRI, Mendeleevo, Moscow area, Russia

e-mail: gubin44@mail.ru

The signals delay value in the receiving-converting channel of the VLBI radio telescope depends on the signal frequency and can be changed under influence of the environment (temperature fluctuations, telescope rotation etc). This should be taken into account while obtained VLBI data processing. The system of phase calibration realizes continuous measurement of the output phase of the special calibration pulse harmonics submitted to the input of the receiver and thus provides monitoring of the delay changing in the receiving-converting channel.

At present phase calibration system is based on thermo-stabilized generators of picoseconds pulses. With these devices it is possible to carry out high accuracy measurement at frequencies not higher than 35GHz. There are significant affected by external factors on the transmission path of the reference signal, which leads to a change in the signal spectrum form and phase fluctuations between harmonics of the generator at frequencies above 20 GHz. Magnitude of such fluctuations becomes significant in Ka range and can reach 60% of the detected signal period. Conventional technical solutions give slight improvement but led to increase of equipment dimensions that is unacceptable for the speedily-rotation and small diameter radio telescopes.

Another way to solve mentioned above problem is to use a fs laser for generation of calibration pulses. Optical spectrum of the fs laser represents a comb of phase locked modes with frequencies $F_n = F_r^*n + F_0$, where F_r is the pulse-recurrence frequency (60-100 MHz in our case) and F_0 - offset frequency which is inessential for application under consideration. In a photodetector optical pulses are converted into radiofrequency domain. The bandwidth of the detector determines duration of the radio pulses and width of the obtained radio spectrum which also represents a comb of phase-locked harmonics. Due to the small dimensions of the photodetector it can be placed near the telescope feed output and, herewith the laser can be placed in the thermo-stabilized room near a frequency standard that facilitate recurrence frequency stabilization. The laser and photodetector are connected via optical fiber line.

The first experiments of phase calibration of radio telescope with using of the fs laser developed by P.N. Lebedev Physical Institute were conducted at the

“Svetloe“ observatory of the Institute of Applied Astronomy. The obtained data are processed and results will be presented at the Conference.

Authors are grateful to “Avesta Ltd.“ for technical support of the experiment.

Sub-natural Linewidth in Two-photon Frequency Comb Spectroscopy

Arthur Matveev^{1,2}, Alexey Grinin¹, Lothar Maisenbacher¹, Vitaly Andreev¹, Dylan Yost^{1,3}, Randolph Pohl¹, Theodor W. Hänsch^{1,2} and Thomas Udem¹

¹ Max-Planck Institut für Quantenoptik, Garching, Germany

² Ludwig-Maximilians-Universität, München, München, Germany

³ now at: Colorado State University, Fort Collins, CO, USA

e-mail: amatvev@mpq.mpg.de

One of the promising methods of high precision sub-Doppler spectroscopy is an excitation of two-photon transitions with counter-propagating frequency combs. This method is of particular interest if the investigated atomic line lays in an ultraviolet region since there it is easier to generate harmonics from pulsed laser rather than CW one. We report about our implementation of this experimental technique to the measurement of the frequency of 1S-3S transition in atomic hydrogen and deuterium at wavelength 205 nm.

Like in conventional two-photon spectroscopy in counter-propagating CW laser beams, in the presented method the atoms are excited in a region, where pulses of counter-propagating mode-locked lasers collide. This region which we call a Pulse Collision Volume (PCV) can have a relatively small size, which allows better control of different systematic effects. A severe problem of the two-photon frequency comb spectroscopy is a presence of the residual first-order Doppler shift, which depends on the chirp of the excitation pulses and a coordinate of the atom in the PCV. We developed a technique which allows us to mitigate this shift by the detection of fluorescence from excited atoms with a limited field of view.

One interesting effect which we found first experimentally, then in numerical simulation, is a possibility that the observed width of the atomic line is less than the natural linewidth of an atomic transition. We found a comprehensive explanation of this effect and discuss it in a presentation.

Spectroscopy of neutral atoms trapped in femtosecond optical dipole trap

A. M. Mashko^{1,2}, A. A. Meysterson^{1,3}, A. E. Afanasiev¹ and V. I. Balykin¹

¹ Institute of Spectroscopy Russian Academy of Sciences, Fizicheskaya Str., 5, Moscow, Troitsk, 108840, Russia;

² National Research University Higher School of Economics, Myasnitskaya str., 20, Moscow, 101000, Russia;

³ Moscow Institute of Physics and Technology, Institutskiy per., 9, Dolgoprudny, Moscow Region, 141700, Russia;

e-mail: anastasiia.mashko@gmail.com

The using of dipole trapping for atom localization has found a lot of fundamental and applied applications: optical atomic clocks, sources of single photons, and experiments in quantum informatics. One of the main factors limiting the use of dipole traps is the ac-Stark effect [1]. The interaction of trapped atoms with localizing potential leads to a shift and broadening of their spectral lines. One of the possible approaches to minimize the effect is the using pulsed interaction of atoms with localizing and probing laser fields. Pulsed interaction of atoms with localizing field was firstly proposed in [2]. It was further developed for constructing single photon sources based on single trapped atom [3].

Pulsed femtosecond laser can be used for atoms trapping with minimal atom to laser field interaction time. For the first time, the use of such approach for atoms trapping with a dipole force was proposed in [4, 5]. In the case of using femtosecond pulses, the interaction time of an atom with a field is only $10^{-7} - 10^{-8}$ of the total localization time, thus the atom remains free for more than 90% of the trapping time. Experimental realization of dipole trapping of atoms with femtosecond laser field was firstly demonstrated in Institute of spectroscopy RAS [6].

Here we are report on the first experimental studies of the spectral properties of atoms localized in the field of femtosecond laser radiation. The spectral properties of atoms localized with pulsed radiation are the same as in the case of using CW laser for atom trapping. This is due to the small period of repetition of laser pulses (12,5 ns in our case) comparing the lifetime of excited state of rubidium atoms (27 ns). According to our theoretical calculations, it is possible to exclude the broadening of spectral lines in case of trapping with pulsed laser radiation at low repetition rate.

The reported study was funded by RFBR according to the research project N18-02-00429.

REFERENCES

[1] H.J. Metcalf and P. Van der Straten, “Laser Cooling and Trapping“, Springer, New York, 1999.

-
- [2] J. Dalibard, S. Reynaud and C. Cohen-Tannoudji, “Proposals of a stable optical trace for neutral atoms “, *Opt. Commun.*, 47, 395 (1983).
- [3] S. Garcia, D. Maxein, L. Hohmann, J. Reichel, and R. Long, “Fiber-pigtailed optical tweezer for single-atom trapping and single-photon generation “, *Appl.Phys.Lett*, 103, 114103 (2013).
- [4] V. I. Balykin, “Motion of an Atom under the Effect of Femtosecond Laser Pulses: From Chaos to partial Localisation “, *JETP Letters*, Vol. 81, 209, (2005).
- [5] D.N. Yanyshchyn, V.I. Balykin, Y.V. Vladimirova, and V.N. Zadkov, “Dynamics of atoms in a femtosecond optical dipole trap “, *Phys.Rev. A*, 87, 033411 (2013).
- [6] A.E. Afanasiev, et. al., “Atom femto trap “, *Proceedings of 8th International Symposium “Modern Problems of Laser Physics “ (MPLP-2018)*, p. 27 (2018).

Preparation of internal states of thulium atoms using optical pumping

D. Mishin¹, A. Golovizin¹, E. Fedorova^{1,2}, K. Khabarova^{1,2}, V. Sorokin^{1,2}, and N. Kolachevsky^{1,2}

¹ P.N. Lebedev Physical Institute, 53 Leninsky prospekt., Moscow 119991, Russia;

² Russian Quantum Center, 100 Novaya St., Skolkovo, Moscow 143025, Russia.

e-mail: dennismishin@mail.ru

An important aspect of experiments with quantum systems is the preparation of their initial states. Such tasks arise while working with ions or ensembles of atoms. In our laboratory we conduct experiments with thulium atoms. Their inner-shell 4f transition between fine sublevels of the ground state is well shielded from external electric fields, which makes this transition a potential candidate for optical frequency standard. In P.N. Lebedev Physical Institute we have successfully laser cooled thulium atoms to temperatures of about 10 μ K [1], performed direct excitation of the clock transition and experimentally determined magic wavelength for this transition [2,3]. We use $|m_F = 0\rangle \rightarrow |m_{F'} = 0\rangle$ component of the 1.14 μ m clock transition, which has several advantages. For example there is no linear Zeeman shift and vector polarizability is always zero. At this point we face the task of preparing the internal states of thulium atoms, and one of the simplest ways to achieve it is optical pumping. This work is devoted to the experiment on the implementation of optical pumping using two different transitions in thulium atoms.

The main idea of optical pumping is searching for so-called dark states — states, in which atoms cease to interact with light. For example, in case of a linearly polarised light exciting the transition between levels with $F = F'$, the state with $m_F = 0$ is dark, and due to spontaneous decay atoms begin to accumulate in this state. Since the spin of the thulium nucleus is $I = 1/2$, there are two types of transitions suitable for this: $|J = 7/2\rangle \rightarrow |J' = J + 1 = 9/2\rangle$ and $|J = 7/2\rangle \rightarrow |J' = J = 7/2\rangle$.

As a first step, we implemented optical pumping using the first-type transition $|J = 7/2, F = 4\rangle \rightarrow |J' = 9/2, F' = 4\rangle$ at a wavelength of 531 nm, which is used for laser cooling. However, since there is a high probability that the excited level decays to the sublevel $|F = 3\rangle$ instead of $|F = 4\rangle$, it is necessary to additionally excite the transition $|F = 3\rangle \rightarrow |F' = 4\rangle$ to return the atoms to the pumping cycle. This process leads to an increased temperature of atomic ensemble. Transitions of the second type do not have this disadvantage.

Optical pumping using the second-type transition at a wavelength of 419 nm was implemented in a 2-D dipole trap. Optimal parameters, such as intensity and detuning of pumping radiation, magnetic field, and pumping duration in both cases were determined using both numerical simulation and experimentally. The degree of polarization achieved was 0.79 for optical pumping to the

central magnetic sublevel $|m_F = 0\rangle$, and 0.75 for $|m_F = -4\rangle$.

REFERENCES

- [1] Sukachev D.D., Kalganova E.S., Sokolov A.V., Fedorov S.A., Vishnyakova G.A., Akimov A.V., Kolachevsky N.N., Sorokin V.N. // Quantum Electronics. 2014. Vol.44, 6, P. 515-520.
- [2] D. Golovizin A.A., Fedorova E.S., Tregubov D.O., Sukachev D.D., Khabarova K.Yu., Sorokin V.N., Kolachevsky N.N. // 2018 arXiv:1809.02215.
- [3] Kalganova E.S., Golovizin A.A., Shevnin D.O., Tregubov D.O., Khabarova K.Yu., Sorokin V.N., Kolachevsky N.N. // Quantum Electronics 2018, Vol. 48, 5, P. 415-418.

Broadband precise spectroscopy using optical frequency combs

A. Nishiyama^{1,2}

¹ Institute of Physics, Faculty of Physics, Astronomy and Informatics, Nicolaus Copernicus University in Toruń, ul. Grudziadzka 5, 87-100 Toruń, Poland;

² Japan Society for the Promotion of Science (JSPS);
e-mail: akiko@fizyka.umk.pl

Optical frequency combs have been widely employed not only as precise optical frequency rulers in the field of precise atomic spectroscopy but also as broadband spectroscopic light sources for molecular spectroscopy which have capabilities of high frequency resolution and precision comparable to precise spectroscopy with single mode lasers. I will present recent development of the optical frequency comb-based broadband spectroscopy, such as dual-comb spectroscopy [1] and Fourier-transform spectroscopy (FTS) [2], which can achieve high resolution surpassing the conventional FTS and exploit high precision of stabilized comb modes. We demonstrated the application of the dual-comb spectroscopy to double-resonance spectroscopy and two-photon spectroscopies and realized precise measurements with sub-Doppler resolution [3,4]. Furthermore, the comb-based FTS was applied to cavity-enhanced spectroscopic techniques [5,6], and we demonstrated collisional line-shape study of second overtone band (0-3) of CO which is crucial for future spectral databases.

The comb-based broadband spectroscopy provides various advantages in frequency resolution, precision and sensitivity, and will be an attractive tool for future applications in various fields.

REFERENCES

- [1] I. Codrington, et al., Phys. Rev. Lett. 100, 013902 (2008).
- [2] P. Masłowski, et al., Phys. Rev. A 93, 021802(R) (2016).
- [3] A. Nishiyama, et al., Opt. Express 24, 25894 (2016).
- [4] A. Nishiyama, et al., Opt. Express 26, 8957 (2018).
- [5] A. Foltynowicz, et al., Physical Review Letters 107, 233002 (2011).
- [6] A. Cygan, et al., J. Chem. Phys. 144, 214202-1 (2016).

Continuous generation of the arbitrary optical waveform based on the optical frequency division

C. Ohae^{1,2,3}, A. Tomura², T. Gavara³, K. Minoshima^{1,2,3}, and
M. Katsuragawa^{1,2,3}

¹ Institute for Advanced Science, University of Electro-Communications, Japan

² Japan Science Technology Agency, ERATO, MINOSHIMA Intelligent Optical Synthesizer, Japan

³ Graduate School of Informatics and Engineering, University of Electro-Communications, Japan
e-mail: ohae-c@uec.ac.jp

The light generated by the optical frequency division is composed of the optical harmonics $1\omega, 2\omega, 3\omega$ ($\omega \sim 100$ THz) that is phase-locked to each other including absolute phase (CEP). By manipulating the phases and amplitudes of such harmonics, arbitrary optical amplitude (electric and magnetic fields) waveforms, such as rectangular, saw tooth, etc., with ultrahigh repetition rate exceeding 100 THz can be continuously generated [1]. These optical waveforms will be a key technology to realize the ultrafast optical computation or optical communication. In this paper, we will report the continuous generation of the arbitrary optical amplitude waveform with 125 THz repetition rate by using the optical frequency division. The experimental apparatus consists of three parts; these are the divide-by-3 optical frequency divider and harmonics generator, the phase and amplitude manipulator, and the waveform determination part. The optical frequency divider generates three phase-locked harmonics $1\omega, 2\omega, 3\omega$. At first, master laser ω_3 , which is stabilized to the reference cavity, and the dividing laser ω_2 , that is adjusted to satisfy the condition $3\omega_2 \sim 2\omega_3$, are prepared. The difference frequency $\omega^1 = \omega_3 - \omega_2$ of these lasers and its second harmonics $\omega^{2'} = 2\omega^1$, which is nearly equal to ω^2 because of the condition $3\omega_2 \sim 2\omega_3$, are generated. Then, the beat signal between $\omega^{2'}$ and ω^2 is detected and fed back to the dividing laser ω_2 to satisfy $\omega^{2'} = \omega^2$. As a result, the master laser frequency is exactly divided into integer ratio, and we obtain three phase-locked harmonics $1\omega, 2\omega, 3\omega$. The sum frequencies $4\omega = 2\omega + 2\omega$ and $5\omega = 2\omega + 3\omega$ are generated on the basis of these three phase-locked harmonics, so that we finally obtain five phase-locked harmonics $1\omega, 2\omega, 3\omega, 4\omega, 5\omega$ [2]. Then, the phase and amplitude relations between these harmonics are manipulated to obtain a desired optical waveform. The phase and amplitude manipulation are realized by simply inserting the dispersive optical medium into the optical path of the harmonics and control its thickness. As the amount of phase manipulation in this method is much larger than 2π , which causes a lot of phase rapping, the phase relation near the optimum will frequently appear in the realistic thickness range [3]. We finally determine the optical waveforms by measuring the phase and amplitude relation including absolute phase. The phase relation of five harmonics are uniquely determined from the measurement the interferences among sum frequencies ($6\omega = 1\omega + 5\omega$, $2\omega + 4\omega$, $3\omega + 3\omega$ and $7\omega = 2\omega + 5\omega$, 3ω

+ 4ω) and that between the sum frequency ($4\omega = 1\omega + 3\omega$) and the original harmonic 4ω , which is sensitive to the absolute phase. The harmonics propagate collinearly through the whole system described above, therefore the system is robust against the phase fluctuation due to the disturbances. In this paper, we selected three target optical amplitude waveforms, sine-pulse and cosine-pulse train, and saw-tooth waveform. Firstly, the optimal amplitude distribution was searched. The target distribution is homogeneous for the pulse train, and 1, 1/2, 1/3 ... for saw tooth. The obtained power of 1st to 5th harmonics was 33, 35, 24, 17, 10 mW for pulse train, 73, 20, 8, 4, 6 mW for saw tooth. Then, the optimal phase distribution was searched. The obtained phase distribution for sine pulse, cosine pulse, and saw tooth were $(0.50, 0.45, 0.60, 0.51, 0.44) \times \pi$, $(0.0, -0.05, -0.10, 0.09, -0.05) \times \pi$, and $(-0.50, 0.43, -0.51, 0.40, -0.43) \times \pi$ respectively. The phase and amplitude relations were stable during the measurement time ~ 30 minutes, so that the obtained waveforms are stable over a long time period. The optical waveforms are reconstructed from the obtained phase and amplitude distribution. The obtained waveforms were sine pulse, cosine pulse, and saw tooth waveform with repetition rate of 125 THz, and are matched to that with the ideal phase distribution. The pulse width was 1.6 fs for the envelope and 830 as for the amplitude waveform. As mentioned above, we have achieved to continuously generate several optical amplitude waveforms having ultrahigh repetition rate of 125 THz. The generated waveforms have sufficient stability and power for the application.

REFERENCES

- [1] T. W. Hansch, *Opt. Commun.* 80, 71-75 (1990).
- [2] N. S. Suhaimi, C. Ohae, T. Gavara, K. Nakagawa, F. -L. Hong, and M. Katsuragawa, *Opt. Lett.* 40, 5802-5805 (2015).
- [3] M. Katsuragawa, K. Yoshii, *Phys. Rev. A* 95, 033846 (2017).

Development of a high-power laser system for an optical lattice at a magic wavelength for thulium optical clock.

D. Provorchenko¹, D.Tregubov¹, A.Golovizin¹, K.Khabarova^{1,2}, V.Sorokin¹,
and N. Kolachevskiy^{1,2}

¹ P.N. Lebedev Physical Institute, 53 Leninsky prospekt, Moscow 119991, Russia;

² Russian Quantum Center, 100 Novaya St., Skolkovo, Moscow 143025, Russia;

e-mail: provorchenko.di@phystech.edu

Optical lattice is the necessary part of high performance optical clocks based on neutral atoms. It is used for confinement of atoms to eliminate first-order Doppler and recoil shifts [1]. To avoid the clock transition frequency shifts due to Stark effect the optical lattice is operated at so-called magic wavelength. In our laboratory we develop optical clock based on neutral thulium atoms. Recently we determined the magic wavelength for 1.14 μm clock transition to be 813.320(6) nm [2]. However, for more precise magic wavelength determination and lattice light shifts characterisation at 10^{-17} level, a deeper lattice is needed.

In this work, we develop a laser scheme based on a semiconductor laser and a tapered amplifier (TA) operating at a of wavelength 813 nm. Compared to a Ti:Sa laser scheme, which was used before, this approach has several advantages. Firstly, we expect higher laser power (up to 2 W vs. 700 mW for Ti:Sa). Secondly, there is a possibility of fast locking of the laser to the cavity. Thirdly, the new scheme does not suffer from modulation at ~ 100 kHz intrinsic to the Ti:Sa laser. Finally, we are able now to use Ti:Sa laser for producing pumping radiation at 418 nm [3].

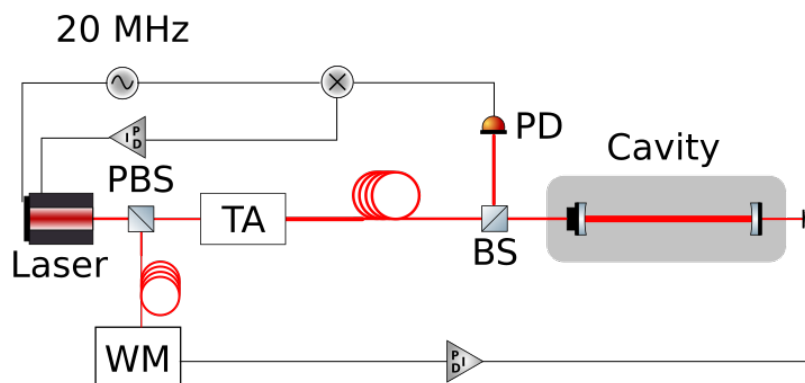

Figure 1: The new optical setup of the optical lattice. PD - photodiode, BS- beam splitter, WM - wavelength meter, TA - tapered amplifier, PBS - Polarizing beam splitter.

For this we plan to build an optical scheme shown in Fig. 1. We expect the inner-cavity power of up to 10 W and the laser frequency stability on the order of 1 MHz, that is more than enough for our purposes. This would allow to determine different lattice light shifts of the Tm optical clock at a target level of 10^{-17} .

REFERENCES

- [1] A. Ludlow, M. Boyd, J. Ye, E. Peik, P. Schmidt, *Rev. Mod. Phys.* 87, 637(2015)
- [2] A. Golovisin, E. Fedorova, D. Tregubov, D. Sukachev, K. Khabarova, V. Sorokin, N. Kolachevsky, *Nat. Commun.* 10, 1-8 (2019)
- [3] E. Fedorova, D. Tregubov, A. Golovizin, G. Vishnyakova, D. Mishin, D. Provorchenko, K. Khabarova, V. Sorokin, N. Kolachevsky, *Quantum Electron.* 49 (5), 418-423 (2019).

Towards transportable optical frequency standard based on a single $^{171}\text{Yb}+$ ion

P. Sidorov¹, I. Semerikov², I. Zalivako², A. Borisenko², M. Aksenov²,
P. Vishnyakov², K. Khabarova², N. Kolachevsky^{1,2}

¹ Russian Quantum Center, Skolkovo, Moscow Region, Russia

² P.N. Lebedev Physical Institute of the Russian Academy of Sciences, Moscow, Russia
e-mail: pavel1778@mail.ru

Optical frequency standards have been developing rapidly for last 20 years. Unprecedented achieved level of stability made it possible to use optical clocks not only for research in fundamental physics but also for technical applications such as navigation and geopositioning. The majority of modern optical clocks are large, complex and fragile systems requiring laboratory conditions, which restricts their application scope. This problem is being tackled by several groups around the world. A transportable lattice optical clock based on strontium atoms housed in a van has been developed at PTB. Also transportable optical clocks based on a single Yb+ ion are being developed at PTB and at FEMTO-ST Institute at the moment. Besides a transportable optical clock based on a single Ca+ ion was developed in China. Here we present a transportable optical frequency standard based on a single $^{171}\text{Yb}+$ ion being developed in Russia by a collaboration of scientific institutes and industrial partners led by LPI. The project goal is to develop a transportable optical clock with a relative instability better than $5 \cdot 10^{-16}$ at a day averaging time, less than 1 m³ in volume and with mass less than 300 kg including all electronics and a frequency comb. One of the important features of our optical clock is its modular design, with fiber interconnections between the parts. This allows for independent adjustment and maintenance of the modules. All lasers are frequency stabilized to a wavemeter while a clock laser and the comb are additionally stabilized with respect to high-finesse ULE cavities. Compact vacuum package with a gold-plated ion trap and an imaging system capable of resolving single particles allow for efficient ion trapment and detection while fitting stringent volume requirements. Here we present current status of the project and results on laser cooling of ytterbium and clock transition interrogation.

Ultimate quantum noise limit of frequency comb measurements: can we read out optical clocks with 10^{-20} precision?

G. Steinmeyer^{1,2}, R. Liao^{1,3}, Y. Song³

¹ Max Born Institute, Berlin, Germany

² Humboldt University, Berlin, Germany

³ Tianjin University, China

e-mail: steinmey@mbi-berlin.de

Since the advent of frequency combs in the early 2000s, the precision of optical clocks has dramatically improved. The latest generation of optical lattice clocks [1] was demonstrated to exhibit a relative precision of 2.5×10^{-19} . If this optical clock could be continuously operated over the age of the universe, a timing error of only 100 ms would accumulate. Such clocks have the prospect of eventually replacing the current primary frequency standards, for enabling fundamental tests, e.g., for providing evidence for a drift of elementary constants, or may also allow construction of a new generation of gravitational wave detectors. However, in either of these applications, it is of paramount importance to reliably count clock cycles. As frequencies in the 100 THz range are far beyond the capabilities of even the most advanced electronic circuits, an optical frequency comb is required to convert the problem of measuring the optical clock frequency into three measurements at microwave frequencies. In particular, one has to measure the comb spacing and the beat frequency between the clock signal and a neighboring comb mode. For an absolute measurement of an unknown frequency, one additionally requires to measure the carrier-envelope frequency, and the latter is typically the most cumbersome of the three measurements. All frequency combs demonstrated to date are laser-based light sources, exhibiting both technical noise mechanisms as well as quantum noise. While technical noise contributions are often narrowband and be eliminated by suitable filtering, broadband spontaneous emission inside the laser imposes a fundamental barrier, which is commonly referred to as Schawlow-Townes noise. In a mode-locked laser, there is an additional timing noise mechanism, which is known as Gordon-Haus jitter. The latter affects the measurement of the comb spacing, but timing-jitter noise is typically too faint to cause any significant degradation of a frequency comb measurement. The case is different for Schawlow-Townes noise, which manifests itself in a $1/f$ flicker-noise mechanism [2], see Fig. 1. At first sight, it appears puzzling that two independent measurements of the carrier-envelope phase slowly dephase on a time scale of several seconds. Splitting the comb signal into two, one would intuitively expect that independent counting of the carrier-envelope signal in two independent f - $2f$ interferometers can only lead to identical results. This somewhat simplistic picture ignores that both, the f and the $2f$ components experience independent phase shifts in either interferometer due to Schawlow-Townes noise, giving rise to a quantum-noise induced phase

difference between the two frequency channels in either interferometer. Given that quantum noise contributions are statistically independent after beam splitting, this mechanism causes a random phase walk between the signals in the f and the $2f$ arm of both interferometers, i.e., a limitation sets in with the dissemination of the signal, even if the clock is perfectly stable. Moreover, given that Schawlow-Townes noise typically mandates linewidths in the sub-hertz range, it actually appears not overly surprising that dephasing effects only set in on time scales of many seconds (cf. Fig. 1).

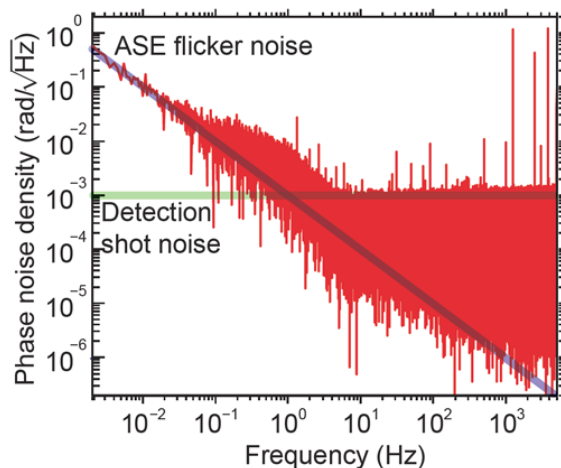

Figure 1: ASE-induced $1/f$ noise and shotnoise detection floor for the example of a CEP stabilized Ti:sapphire laser. This measurement was acquired out-of-loop of a CEP stabilized laser, which was stabilized with the feed-forward technique. This measurement shows that in-loop and out of- loop measurement slowly dephase on a scale of many seconds or minutes, despite the lock.

This rather slow dephasing effect has also been observed and confirmed by several independent research groups [2-4] with nearly identical characteristic $1/f$ functional behavior. The observed flicker noise causes a Schawlow-Townes drift mechanism, which becomes a limiting factor when relative precisions below $\sim 10^{-20}$ are to be addressed. In a similar way, thermal drift has always been limiting quartz oscillators. While these effects are currently not limiting frequency metrology, our findings indicate that the precision prospect of optical frequency is probably not unlimited either, and it seems that we are going to feel limiting effects in the near future. In other words: similar to Moore's law in electronics, any exponential growth behavior so far met a game stopper, and it seems that Schawlow-Townes noise may exactly act as the latter for precision frequency metrology.

REFERENCES

- [1] G. E. Marti et al., Phys. Rev. Lett. 120, 103201 (2018).
- [2] Y. Song et al., Opt. Lett. 39, 6989-6992 (2014).
- [3] T. M. Fortier et al., Opt. Lett. 27, 1436 (2002).
- [4] T. Fuji et al., New J. Phys. 7, 116 (2005).

Stark and Zeeman shifts in thulium optical clock

D. Tregubov¹, A. Golovizin¹, E. Fedorova^{1,2}, D. Sukachev^{1,3}, K. Khabarova^{1,2},
V. Sorokin^{1,2}, and N. Kolachevsky^{1,2}

¹ P.N. Lebedev Physical Institute, 53 Leninsky prospekt., Moscow 119991, Russia;

² Russian Quantum Center, 100 Novaya St., Skolkovo, Moscow 143025, Russia;

³ Physics Department of Harvard University, 17 Oxford Str., Cambridge, MA, 02138, USA

e-mail: treg.dim@gmail.com

In the past two decades optical atomic clocks experienced a rapid development. They surpassed the primary caesium standards in stability and accuracy more than a decade ago, and more atomic species are joining in [1]. Our group is involved in a study of a promising optical clock based on thulium atoms [2]. Here we report on precision spectroscopy of a clock transition in ¹⁶⁹Tm.

We use an inner-shell magnetic dipole transition

$$|J = 7/2, F = 4, m_F = 0\rangle \rightarrow |J = 5/2, F = 3, m_F = 0\rangle$$

between the fine-structure components of the ground electronic state at the wavelength of 1.14 μm as a clock one. The upper level lifetime of 112(4) ms measured in the optical lattice [3] is consistent with the theoretically predicted linewidth of 1.2 Hz.

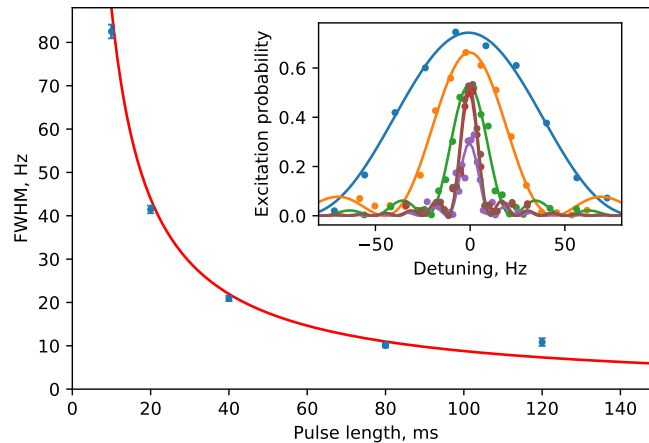

Figure 1: Full width at half maximum of clock transition excitation spectra (see inset) versus Rabi pulse length.

Theoretical predictions and experimental measurements of the magic wavelength for this transition allowed us to achieve Fourier-limited spectral linewidth of the clock transition as shown in Fig. 1. Since the lifetime of the clock transition is 112(4) ms, increasing the Rabi pulse length further leads to a drop in contrast. A 1.14 μm laser used here for the clock transition interrogation was stabilized to a high-finesse ultralow-expansion cavity to narrow its linewidth. Achieved narrow-linewidth spectra allowed us to perform clock transition shift

measurements with a 1 Hz resolution. For example, measured clock transition frequency shift due to second order Zeeman effect is shown in Fig. 2. From the experimental data we find a sensitivity coefficient to be $258.3(3)$ Hz/Gs², while the theoretical prediction is 257.2 Hz/Gs².

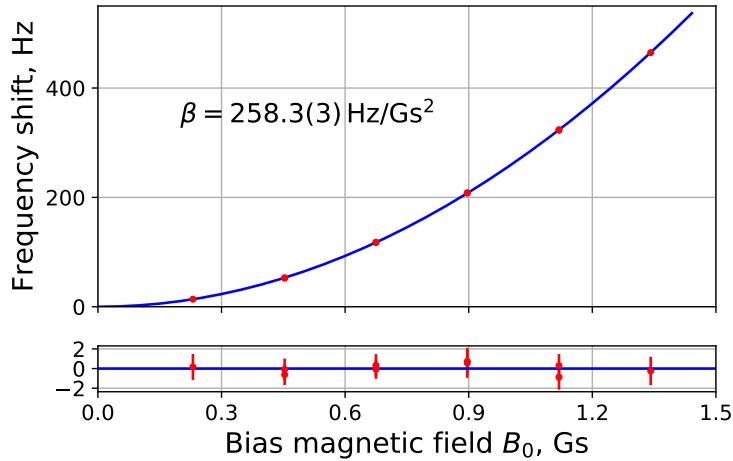

Figure 2: Quadratic Zeeman shift of the clock transition frequency (top), and residuals from a parabolic fit $\Delta\nu = \beta B_0^2$ (bottom).

We estimated a total relative uncertainty of the clock transition frequency in Tm to be $< 5 \times 10^{-18}$ with major contributions from the second order Zeeman shift and an optical lattice Stark shift. The second order Zeeman shift in Tm can be fully canceled by measuring an averaged frequency of two clock transitions $|F = 4, m_F = 0\rangle \rightarrow |F = 3, m_F = 0\rangle$ and $|F = 3, m_F = 0\rangle \rightarrow |F = 2, m_F = 0\rangle$ with the quadratic Zeeman coefficients of the opposite signs. The uncertainty of the lattice Stark shift is mostly associated with an angular dependency of the tensor polarizability, that can be routinely controlled below 5×10^{-18} level. It is worth noting that the clock transition in Tm has low sensitivity to blackbody radiation with only 2.3×10^{-18} relative frequency shift at room temperature [4]. In the future, it could facilitate in developing of a transportable Tm optical clock with 10^{-17} relative uncertainty.

REFERENCES

- [1] A. Ludlow, M. Boyd, J. Ye, E. Peik, and P. Schmidt, Rev. Mod. Phys. **87**, 637 (2015).
- [2] D. Sukachev, S. Fedorov et al., Physical Review A **94**, 022512 (2016).
- [3] A. Golovizin, E. Kalganova et al., Journal of Physics: Conf. Series **941**(1), 012114 (2017).
- [4] A. Golovizin, E. Fedorova et al., Nat. Commun. **10**, 1724 (2019)

Optical frequency transfer over 940 km fiber link connecting MPQ and PTB

G. Vishnyakova¹, R. Holzwarth^{2,3}, T. Udem^{2,4}, N. Kolachevsky¹, A. Kuhl⁵,
T. Waterholter⁵, S. Koke⁵ and G. Grosche⁵

¹P. N. Lebedev Physical Institute of the Russian Academy of Sciences, Moscow, Russia

²Max-Planck-Institut für Quantenoptik (MPQ), Garching, München, Germany;

³Menlo Systems GmbH, Martinsried, München, Germany

⁴Ludwig-Maximilians-Universität, München, Germany

⁵Physikalisch-Technische Bundesanstalt (PTB), Braunschweig, Germany

e-mail: gulnarav7@gmail.com

Long optical fiber links allow to disseminate ultrastable frequency and time signals between distant laboratories [1,2]. I will report on the new established underground dark fiber connecting the Physikalisch-Technische Bundesanstalt (PTB) in Braunschweig and the Max-Planck-Institut für Quantenoptik (MPQ) in Garching near Munich via the Karlsruhe Institute of Technology (KIT) with the length of 940 km (“west“ link) (fig. 1). The link is equipped with 4 fiber Brillouin amplifiers and 1 erbium-doped fiber amplifier for the compensation of attenuation in the fiber which is 0.23 dB/km at 1.5 μm wavelength.



Figure 1: Simplified scheme of optical fiber connecting MPQ and PTB institutes. Yellow markers stand for the amplifiers.

Active noise compensation allows to reach relative instability of 3×10^{-19} and uncertainty of 1.3×10^{-19} at 4000 seconds of averaging which gives negligible impact on chronometric levelling with a transportable optical clock [3]. The established link can be used for precision measurements of Hydrogen transition frequencies at MPQ in terms of frequency standards at PTB [4].

Another interesting application may be the measuring of the Sagnac effect if combine this “west“ link with another “east“ link to form ring interferometer and measure the deviations of the signal due to variety of geo- and seismic- effect [5,6].

REFERENCES

- [1] G. Grosche et al., *Optics Letters* 34 (15), 2270 (2009).
- [2] S. Droste et al., *Physical Review Letters* 111, 110801 (2013).
- [3] J. Grotti et al., *Nature Physics* 14, 437 (2018).
- [4] A. Matveev et al., *Phys. Rev. Lett.* 110, 230801 (2013).
- [5] J. Salvermoser et al., *Seismological Research Letters* 88 (3), 935 (2017).
- [6] C. Clivati et al., *Optics Letters* 38 (7), 1092 (2013).

Solid-state Yb:KYW optically referenced frequency comb for precision spectroscopy of He+

I. V. Zalivako¹, A. Ozawa², F. Schmid², J. Weitenberg^{2,3}, T. W. Hänsch^{2,4} and Th. Udem^{2,4}

¹ P.N. Lebedev Physical Institute of the Russian Academy of Sciences, Moscow, Russia

² Max Planck Institute of Quantum Optics, Garching, Germany

³ Fraunhofer Institute for Laser Technology, Aachen, Germany

⁴ Ludwig Maximilian University, Munich, Germany

e-mail: zalikes@yandex.ru

Rapid development of femtosecond frequency combs in XUV spectral region in last decades opened a direct way for a precision spectroscopy of several atomic transitions playing an important role in fundamental science. One of such transitions is a 1s-2s two-photon line in He+ ion. Precise measurement of its absolute frequency allows for highly sensitive test of bound-state QED and can contribute to a proton size puzzle and fundamental constants determination. At Max Planck Institute of Quantum Optics (Germany) an experiment is being set up aimed for a precision spectroscopy of this transition in a trapped and sympathetically laser cooled He+ ions via direct frequency comb spectroscopy method. To perform such a measurement a frequency comb centered at 61 nm is required. It will be generated as a 17th harmonic of a near-infrared comb at 1.03 μm through a high harmonic generation (HHG) process. Strong amplification of the initial comb phase noise during HHG puts extremely strict requirements on the seed comb performance. Here we present a solid-state Yb:KYW frequency comb at 1.03 μm which was developed for this project. Kerr-lens modelocking technique is expected to provide a low phase noise level as well as a flat spectral phase. The comb is pumped with a 981 nm diode laser and possesses a repetition rate of 40 MHz, which is matched to a free spectral range of an enhancement cavity for HHG. Tuning of the comb output spectrum is achieved by introducing an interference filter inside the laser cavity. High degree of acoustic and thermo isolation ensures good level of long-term stability and robustness. The comb is stabilized in the optical domain to an ultrastable cavity made of ULE glass through an auxiliary filter-based external cavity diode laser at 1.03 μm . The comb stabilization is implemented with a piezo-actuated laser mirror and an extra-cavity AOM in feed-forward or feed-back schemes. Preliminary results of the comb stabilization will be presented, as well as a progress of the whole project.

Ultrastable lasers for optical clocks and fundamental research

N. O. Zhadnov^{1,2}, K. S. Kudeyarov^{1,2}, D. S. Kryuchkov^{1,2}, G. A. Vishnyakova¹,
K. Yu. Khabarova^{1,2} and N. N. Kolachevsky^{1,2}

¹Lebedev Physical Institute, Moscow, Russia

²Russian Quantum Center, Moscow, Russia;

e-mail: nik.zhadnov@yandex.ru

Precision spectroscopic measurements is a vital technique for both fundamental and applied physical research. Thanks to laser sources with ultra-narrow spectral linewidth lots of state-of-the-art experiments finally became possible: detection of gravitational waves (LIGO, VIRGO), tests of QED (proton size puzzle), development of optical clocks with long-term fractional frequency instability beyond $1 \cdot 10^{-18}$ and sensitive to Earth's gravitational field. There are proposals of dark matter detection with the help of a net of ultrastable lasers and optical clocks.

Unprecedented fractional frequency instability of modern stabilized lasers of a few $1 \cdot 10^{-17}$ is provided by reference Fabry-Perot cavities and is fundamentally limited by their thermal noise level. Various types of noises also affect the frequency stability of an ultrastable laser system: vibrations, temperature fluctuations, various instabilities in the opto-electronic feedback loop.

In LPI we work on ultastable lasers, stabilized by two types of reference oscillators: cryogenic silicon and very long room-temperature ULE-glass cavities [1,2]. These types of cavities have a very low thermal noise limit and are able to provide stability to lasers on the level of $1 \cdot 10^{-16}$. In the current project status we have two lasers stabilized to modes of cooled silicon ultrastable Fabry-Perot cavities and now we work on their comparison to find out their instability and to improve it. Study of noises in opto-electronic feedback loop and methods to cancel them to the level, lower than thermal noise limit is in progress. The features and difficulties one meets during development of ultrastable laser systems will be discussed.

REFERENCES

- [1] N.O. Zhadnov, K.S. Kudeyarov, D.S. Kryuchkov, I.A. Semerikov, K.Yu. Khabarova and N.N. Kolachevsky, "On the thermal noise limit of ultrastable optical cavities", *Quantum Electronics*, 2018, 48(5), 425-430
- [2] N.O. Zhadnov, G.A. Vishnyakova, K.S. Kudeyarov, D.S. Kryuchkov, K.Yu. Khabarova and N.N. Kolachevsky, "Temperature drift contribution to frequency instability of silicon Fabry-Perot cavities", *Quantum Electronics*, 2019, 49(5), 424-428

Author Index

- Afanasiev
Anton, 274
- Alekhin
Alexandr, 108
- Alkhimova
Mariya, 16
- Amans
David, 110
- Amendola
Vincenzo, 111
- Anashkina
Elena, 250
- Andreev
Nikolay, 17
- Andrianov
Alexey, 251
- Arantchouk
Leonid, 180
- Arissian
Ladan, 181
- Aseyev
Sergey, 72
- Babushkin
Ihar, 183
- Balakireva
Irina, 276
- Bezhanov
Stanislav, 73
- Bochkarev
Sergey, 19
- Brantov
Andrey, 21
- Bulgakova
Nadezhda, 74
- Burdukova
Olga, 252
- Busleev
Nikolay, 112
- Chekalin
Sergey, 185
- Cheng
Ya, 113
- Chimier
Benoit, 114
- Chizhov
Pavel, 187
- Chvykov
Vladimir, 254
- Colombier
Jean Philippe, 115
- Courvoisier
Francois, 117
- Danilov
Pavel, 118
- Degtyarev
Sergei, 156
- Del Fatti
Natalia, 119
- Dmitriev
Egor, 22
- Efimenko
Evgeny, 23
- Emelyanenko

- Kirill, 120
- Fedotov
 Alexander, 24
 Andrei, 188
- Fedotova
 Olga, 121
- Feng
 Jie, 25
- Frolov
 Alexander, 75
- Fronya
 Anastasiya, 123
- Gaal
 Peter, 76
- Gakovič
 Biljana, 124
- Garcia
 Martin, 77
- Garmatina
 Alena, 126
- Geints
 Ilia, 190
 Yuri, 191
- Gelfer
 Evgeny, 26
- Gladush
 Yuriy, 256
- Glebov
 Evgeny, 230
- Golovan
 Leonid, 128
- Gorlova
 Diana, 27
- Gospodinov
 Georgy, 28
- Gozhev
 Denis, 29
- Grabtchikov
 Alexander, 192
- Grishin
 Mikhail, 257
- Grishkov
 Vyacheslav, 78
- Grudtsyn
 Yakov, 200
- Gruzdev
 Vitaly, 79, 231
- Gubin
 Mikhail, 278
- Horn
 Alexander, 81
- Hrabovsky
 Jan, 83
- Husinsky
 Wolfgang, 129
- Igor
 Andriyash, 18
- Ilday
 Fatih Ömer, 130
 Serim, 131
- Inogamov
 Nail, 132
- Ivanov
 Anatoly, 232
 Dmitry, 134
 Konstantin, 31
- Ivanova
 Anastasiya, 136
- Izquiedro
 Manuel, 84
- Kashaev
 Fedor, 138
- Khazanov
 Efim, 258
- Kitaeva
 Galiya, 193
- Klimov
 Vasliy, 139
- Klokov
 Andrei, 140, 141

- Kochetkov
 Yury, 33
- Kolchin
 Alexander, 142
- Koribut
 Andey, 195
- Korneev
 Philipp, 35
- Korshunov
 Vladislav, 234
- Korzhimanov
 Artem, 36
- Kostenko
 Oleg, 37
- Kostin
 Vasily, 86
- Kostyukov
 Igor, 38
- Krylach
 Irina, 144
- Kuchmizhak
 Alexandr, 145
- Kudryashov
 Sergey, 146
- Kulagin
 Victor, 39
- Kuratov
 Andrey, 40
- Kuznetsov
 Sergey, 41
- Leonov
 Stanislav, 259
- Lobok
 Maxim, 42
- Loginova
 Maria, 197
- Losev
 Valery, 261
- Lysak
 Tatiana, 199
- Makarov
 Sergey, 43
- Makin
 Vladimir, 147
- Mamontova
 Tatiana, 88
- Mashko
 Anastasia, 281
- Matveev
 Arhur, 280
- Matveevskii
 Konstantin, 44
- Melentiev
 Pavel, 148
- Menuier
 Michel, 237
- Mereschenko
 Andrey, 236
- Metelskii
 Igor, 45
- Migal
 Ekaterina, 90
- Mikhailova
 Tatiana, 239
 Valentina, 240
- Mikheytshev
 Nikita, 46
- Milant'ev
 Vladimir, 47
- Minh
 Pham Hong, 262
- Mirza
 Inam, 149
- Mishin
 Denis, 283
- Mitina
 Ekaterina, 201
- Miyaji
 Godai, 151
- Mollica
 Florian, 263

- Mordvintsev
 Ilya, 48
- Murzanev
 Aleksey., 202
- Mysyrowicz
 Andre, 203
- Nakata
 Yoshiki, 153
- Nastulyavichus
 Alena, 155
- Nazarov
 Maxim, 204
- Nefedova
 Viktoria , 91
- Nikolaeva
 Irina, 206
- Nishiyama
 Akiko, 285
- Oguri
 Katsuya, 92
- Ohae
 Chiaki, 286
- Oladyshkin
 Ivan, 94
- Oliva
 Eduardo, 207
- Pankratov
 Vladislav, 208
- Pershin
 Sergey, 265, 266
- Planken
 Paul, 95
- Polynkin
 Pavel, 268
- Popov
 Alexander, 97
 Vyacheslav, 50
- Potemkin
 Fedor, 209
- Pozdnyakov
 Ivan, 241
- Prokudin
 Vladislav, 51
- Provorchenko
 Daniil, 288
- Pugacheva
 Daria, 52
- Pukhov
 Alexander, 53
- Pushkin
 Andrey, 269
- Romashevskiy
 Sergey, 157
- Rovnyagina
 Nataliya, 242
- Rumiantsev
 Boris, 210
- Ryazantsev
 Sergey, 54
- Safronov
 Konstantin, 55
- Saraeva
 Irina, 158
- Semenov
 Timur, 56
- Senjkevich
 Alexandra, 58
- Sentis
 Marc, 59
- Serebryakov
 Dmitry, 61
- Shirshin
 Evgeny, 243
- Shiryaev
 Oleg, 62
- Shylyapov
 Sergey, 63
- Sidorov
 Pavel, 290
- Sitnikov

- Dmitry, 212
- Skorb
 Ekaterina, 160
- Smirnov
 Nikita, 161
- Soma
 Venugopal Rao, 163
- Staude
 Isabelle, 165
- Steinmeyer
 Günter, 291
- Stepanenko
 Svetlana, 214
- Sugioka
 Koji, 166
- Suraud
 Eric, 64
- Tcypkin
 Anton, 215
- Ter-Avetisyan
 Sargis, 65
- Tkachenko
 Victor, 98
- Tokmacheva-Kolobova
 Anastasiia, 168
- Tregubov
 Dmitry, 293
- Trigub
 Maxim, 270
- Tsipotan
 Aleksei, 169
- Tsymbalov
 Ivan, 66
- Urgapov
 Dmitry, 217
- Ushakov
 Aleksandr, 219
- Ustinov
 Alexey, 220
- Vagin
 Konstantin, 99
- Vais
 Olga, 67, 68
- Vallee
 Fabrice, 171
- Vesyman
 Mikhail, 69
- Vishnyakova
 Gulnara, 295
- Vitrik
 Oleg, 172
- Vodchits
 Alexander, 222
- Yartsev
 Arkady, 244
- Yermolenko
 Igor, 246
- Yushkov
 Konstantin, 271
- Zabotnov
 Stanislav, 173
- Zalivako
 Ilia, 297
- Zaloznaya
 Elizaveta, 223
- Zavorotniy
 Akim, 49
- Zayarny
 Dmitry, 175
- Zhadnov
 Nikita, 298
- Zheltikov
 Aleksei, 225
- Zhigunov
 Denis, 176
- Zhou
 Norman, 177
- Zhukova
 Maria, 101
- Zhvaniya

Irina, 70
Zier
Tobias, 103
Zubko
Aleksei, 104

Zvagelsky
Roman, 178
Zyatikov
Ilia, 227

Editors:

Stanislav Bezhanov

Daria Mokrousova

Printing design

Daria Mokrousova

Отпечатано на средства, предоставленные Министерством образования и науки Российской Федерации на поддержку конференции International Conference on Ultrafast Optical Science (UltrafastLight-2019).